



expertmeter™ PM180

PM180 Series SUBSTATION AUTOMATION UNIT

OPERATION MANUAL



LIMITED WARRANTY

The manufacturer offers the customer a 24-month functional warranty on the instrument for faulty workmanship or parts from date of dispatch from the distributor. In all cases, this warranty is valid for 36 months from the date of production. This warranty is on a return to factory basis.

The manufacturer does not accept liability for any damage caused by instrument malfunction. The manufacturer accepts no responsibility for the suitability of the instrument to the application for which it was purchased.

Failure to install, set up or operate the instrument according to the instructions herein will void the warranty.

Only a duly authorized representative of the manufacturer may open your instrument. The unit should only be opened in a fully anti-static environment. Failure to do so may damage the electronic components and will void the warranty.

The greatest care has been taken to manufacture and calibrate your instrument. However, these instructions do not cover all possible contingencies that may arise during installation, operation or maintenance, and all details and variations of this equipment are not covered by these instructions.

For additional information regarding installation, operation or maintenance of this instrument, contact the manufacturer or your local representative or distributor.

WARNING

Read the instructions in this manual before performing installation, and take note of the following precautions:

- Ensure that all incoming AC power and other power sources are turned OFF before performing any work on the instrument. Failure to do so may result in serious or even fatal injury and/or equipment damage.
- Before connecting the instrument to the power source, check the labels on the back of the instrument to ensure that your instrument is equipped with the appropriate power supply voltage, input voltages and currents.
- Under no circumstances should the instrument be connected to a power source if it is damaged.
- To prevent potential fire or shock hazard, do not expose the instrument to rain or moisture.
- The secondary of an external current transformer must never be allowed to be open circuit when the primary is energized. An open circuit can cause high voltages, possibly resulting in equipment damage, fire and even serious or fatal injury. Ensure that the current transformer wiring is secured using an external strain relief to reduce mechanical strain on the screw terminals, if necessary.
- Only qualified personnel familiar with the instrument and its associated electrical equipment must perform setup procedures.
- Do not open the instrument under any circumstances when it is connected to a power source.
- Do not use the instrument for primary protection functions where failure of the device can cause fire, injury or death. The instrument can only be used for secondary protection if needed.

Read this manual thoroughly before connecting the device to the current carrying circuits. During operation of the device, hazardous voltages are present on input terminals. Failure to observe precautions can result in serious or even fatal injury or damage to equipment.

All trademarks are property of their respective owners.

Apr 2019

Copyright 2010-2019 © SATEC Ltd.

Table of Contents

- Chapter 1 Introduction7**
 - expertmeter™ PM180 Features.....7
 - AC/DC Inputs.....9
 - Digital and Analog I/O module Options.....9
 - Communications Options9
 - Remote Displays10
 - Upgradeable Firmware.....11
 - Device Models.....11
 - Firmware Versions.....11
 - Supplemental Documents12
- Chapter 2 Device Description.....13**
 - Controls and Indicators13**
 - Device Controls.....13
 - Indicator LEDs13
 - Modes of Operation13**
 - Operational Mode.....13
 - Energy Test Mode13
 - Service Mode13
 - Diagnostics Mode13
 - Communicating with the PM180.....14**
 - COM1-COM3 Serial Communications (standard)14
 - COM4 Infrared Port (optional)14
 - COM5 Port (optional).....15
 - USB Port (standard)15
 - Ethernet Port (standard)15
 - Ethernet Port (optional)15
 - CELLULAR Port (optional).....15
 - Using the RDM and RGM.....16
 - Using PAS.....16
 - Device Inputs.....16**
 - AC Inputs16
 - VDC Input17
 - Digital Inputs.....17
 - Analog Inputs17
 - Device Outputs.....17**
 - Analog Outputs17
 - Relay Outputs18
 - Metering19**
 - RMS Measurements.....19
 - RMS Trace.....19
 - Harmonic Measurements.....19
 - Aggregation Intervals20
 - Demands.....21
 - Energy Metering.....22
 - Instrument Transformer Correction.....22
 - Monitoring23**
 - Substation Battery.....23
 - Memory Backup Battery.....23

Power Supply	23
Logical Controller	23
Recording	23
Event Recorder	23
Sequence-of-Events Recorder.....	24
Power Quality Recorder	24
Fault Recorder	24
Fast Transient Recorder	24
Phasor Measurement Unit - PMU	25
Measuring Techniques	25
PMU Communications	27
Time Synchronization	30
Device Diagnostics	31
Chapter 3 Using the RDM	32
Connecting the RDM.....	32
Data Display	32
Navigation Keys	33
Common Measurements Display	34
Min/Max and Max. Demand Display	35
Power Quality Display	35
Energy Display	36
Status Information Display	36
Using the Menus	37
Navigation Keys	37
Selecting Menus.....	38
Entering a Password.....	38
Entering Numbers	38
Configuring the RDM	39
Configuring the PM180.....	39
Clock Setup Menu	39
Basic Setup Menu.....	41
Demand Setup Menu	42
Communication Setup Menus	42
Device Options Menu.....	43
Access Control Menu	44
Reset Menu	44
Chapter 4 Using Telnet	46
Connecting to the Device.....	46
Running Telnet from HyperTerminal	46
Running the Telnet Client on Windows XP and other	47
Opening a Telnet Session.....	47
Closing a Telnet Session	48
Chapter 5 Using PAS.....	49
Installing PAS.....	49
Installing the USB Driver.....	49
Windows XP Installation.....	49
Creating a New Site for your Device	50
Setting up Communications	51
Communicating through a Serial Port.....	51
Communicating through a Modem (future)	52
Communicating through the Internet	53

Communicating through a CELLULAR (GPRS-2G or 3G) Modem	53
Communicating through a USB	54
Setting Up the Device	54
Creating Setups for the Device	54
Copying Setups to the Device Database	55
Downloading Setup to the Device	55
Uploading Setup from the Device.....	55
Chapter 6 Programming the PM180	56
Authorization	56
Changing Port Settings.....	56
Setting Up Communication Ports.....	56
Setting Up the ETHERNET - Local Network	57
Setting-Up CELLULAR - Public Network.....	57
Setting-Up SNMP Client	59
Configuring eXpertPower Client	59
Basic Device Setup.....	61
Device Options.....	63
Instrument Transformer Correction Setup.....	65
Local Settings	65
Configuring Digital Inputs.....	68
Programming Relay Outputs	70
Programming Analog Inputs	72
Programming Analog Outputs	73
Using Counters	75
Using Periodic Timers.....	75
Using Control Setpoints.....	76
Configuring the PMU IEC 61850 SV publisher	80
Configuring IEEE C37.118.2.....	82
Chapter 7 Configuring Recorders	84
Configuring Device Memory	84
Configuring the Event Recorder	86
Configuring the Sequence-of-Events Recorder	87
Configuring the Data Recorder	89
Conventional Data Log Files	89
Factory Preset Periodic Data Logs.....	90
IEC 61000-4-30 Profile Data log	91
Factory Preset Fault and PQ Data Logs.....	94
TOU Profile Data Log Files	94
Configuring the Waveform Recorder.....	95
Configuring the IEEE 1159 Power Quality Recorder.....	96
Configuring the EN50160 Power Quality Recorder	99
EN50160 Background	99
Evaluation Techniques	100
Methods of Evaluation	101
Configuring the EN50160 Recorders.....	106
EN50160 PQ Recorder Setup.....	106
EN50160 Harmonics Limits Setup	108
EN50160 Advanced Setup	109
Clearing EN50160 Evaluation Counters.....	110
Configuring the Fault Recorder.....	110
Configuring the Fault Locator	112

Fault Location calculations results.....	115
Chapter 8 Totalization Energy and TOU Registers.....	117
Configuring Summary and Billing/TOU Registers	117
Configuring TOU Daily Profiles	118
Configuring TOU Calendar	119
Chapter 9 Configuring Communication Protocols	121
Configuring MODBUS	121
MODBUS Point Mapping.....	121
Changing Raw Scales for 16-bit Registers.....	121
Configuring DNP3.....	122
DNP Options.....	122
Configuring DNP Class 0	123
Configuring DNP Event Classes.....	124
Configuring IEC 60870-5	125
Configuring IEC 60870-5 Options.....	126
Remapping Point Addresses and Event Reporting.....	128
Configuring Class 2 Data and Counter Transmission	129
Chapter 10 Device Control.....	132
Authorization.....	132
Remote Relay Control	132
Device Event Flags	133
Viewing and Clearing Device Diagnostics	133
Updating the Clock	134
Resetting Accumulators and Clearing Log Files.....	134
Upgrading Meter Firmware	134
Chapter 11 Monitoring Devices.....	136
Viewing Real-time Data	136
Organizing Data Sets.....	136
Polling Devices.....	136
Viewing a Data Table.....	137
Viewing Data Trend.....	138
Saving Data to a File	139
Printing Data	139
Copying Data.....	139
Real-time Data Logging	139
Viewing Real-time Min/Max Log	140
Viewing Real-time Waveforms.....	140
Chapter 12 Retrieving Recorded Files.....	141
Uploading Files on Demand.....	141
Using the Upload Scheduler	141
Retrieving EN50160 Statistics Files.....	143
Viewing Historical Data On-line.....	143
Chapter 13 Viewing Log Files.....	144
General Operations.....	144
Opening a Log File	144
Copying Data	144
Saving Data to a File	144
Printing Reports	144
Customizing Views	144

Viewing the Event Log	144
Viewing the IEC 61000-4-30 Profile log file	146
Viewing the Sequence-of-Events Log.....	147
Viewing the Power Quality Event Log	148
Viewing the ITI (CBEMA) Curve.....	149
Viewing the IEEE 1159 Statistics Report	150
Viewing EN50160 Statistics Reports	152
Viewing the EN50160 Compliance Report	152
Viewing the EN50160 Online Statistics Report.....	155
Viewing the EN50160 Harmonics Survey Report.....	155
Viewing the Fault Log.....	155
Viewing the Data Log	156
Viewing Data Trend.....	157
Viewing Waveforms	158
Viewing an RMS Plot.....	159
Viewing a Frequency Plot.....	160
Viewing a Spectrum Chart.....	160
Viewing a Spectrum Table.....	161
Waveform Options	162
Viewing Synchronized Waveforms	165
Chapter 14 COMTRADE and PQDIF Converters	166
Manual Converting.....	166
Automatic Converting	166
Appendix A Parameters for Analog Output	168
Appendix B Setpoint Actions	170
Appendix C Parameters for Monitoring and Data Logging.....	171
Appendix D EN50160 Statistics Log Files	189
Appendix E Data Scales.....	193
Appendix F Device Diagnostic Codes	194

Chapter 1 Introduction



expertmeter™ PM180 Features

The expertmeter™ PM180 Series intelligent electronic devices (IED) in a 3U standard form factor design, are combined fault-recording, metering and control devices that provide a complete solution for substation and industrial automation. They incorporate a unique collection of features commonly found in numerous specialized measurements and recording equipment utilized in substation and industrial environments. Although the devices are primarily designed as an inexpensive add-on to expand the capabilities of the existing substation protection equipment, they are well suited for a wide range of industrial applications with high input currents whenever extensive power quality monitoring is required. The PM180 combines in a single enclosure:

- Fast Digital Fault recorder: up to 48 external digital triggers from protection relays; onboard fault detector; programmable fault thresholds and hysteresis; up to 100 Amp fault currents, zero-sequence currents and volts, current and voltage unbalance; ready-for-use fault reports - fault current magnitudes and duration, coincident volt magnitude, fault waveforms and fast RMS trace; cross triggering between multiple devices via digital inputs for synchronous fault capture and recording.
- Sequence-of-Events recorder: up to 48 digital inputs at 1-ms resolution, fault events and relay operations.
- IEEE 1159 Power Quality recorder: onboard power quality analyzer; programmable thresholds and hysteresis; IEEE 1159 PQ event log; ready-for-use reports; impulsive transients, sags/swells, interruptions, harmonics, inter-harmonics, frequency variation, voltage unbalance, optional IEC 61000-4-15 flicker.
- EN 50160 Power Quality recorder: onboard power quality analyzer; programmable limits; EN 50160 power quality event log, EN 50160 compliance statistics; EN 50160 harmonics survey statistics; ready-for-use compliance statistics reports; power frequency, voltage variations, rapid voltage changes, IEC 61000-4-15 flicker, voltage dips, interruptions, temporary Overvoltages, transient Overvoltages, voltage unbalance, IEC 61000-4-7 harmonic and Interharmonic voltage, mains signaling voltage.
- GOST13109-97 or GOST 32144-2013 (Russian Power Quality standard) onboard power quality analyzer; programmable thresholds and hysteresis; ready-for use reports)
- Event recorder for logging internal diagnostics events, control events and I/O operations.
- Eight Fast Waveform recorders: 56-channel simultaneous recording with 7 AC, one AC/DC and 48 digital input channels; optional 32-channel recording with 7 AC, one AC/DC, 16 digital and 8 fast analog input channels;

selectable AC sampling rate of 32, 64, 128 or 256 samples per cycle; 20 pre-fault cycles, 1-ms resolution for digital inputs; synchronized waveforms from multiple devices in a single plot; exporting waveforms in COMTRADE and PQDIF file formats.

- Sixteen Fast Data recorders: 1/2-cycle to 2-hour RMS envelopes; up to 20 pre-fault and post-fault cycles; programmable data logs on a periodic basis and on any internal and external trigger; triggering from the Fault recorder, PQ recorder or control setpoints; exporting data trends in PQDIF file format.
- Embedded Programmable Controller: 64 control setpoints, OR/AND logic, extensive triggers, programmable thresholds and delays, relay control, event-driven data recording, cross triggering between multiple devices via the Ethernet for synchronous event capture and recording – up to sixteen triggering channels.
- High-Class 3-phase Power meter: true RMS, volts, amps, powers, power factors, unbalance, and neutral current.
- Demand Meter: amps, volts, harmonic demands.
- Precise Energy and Power Demand Meter: Time-of-Use (TOU), 16 Summary (totalization) and TOU energy and demand registers for substation energy management; accumulation of energy pulses from external watt-meters; block and sliding demands; up to 64 energy sources.
- Harmonic Analyzer: up to 63rd harmonic volts and amps; directional power harmonics and power factor; phasor, symmetrical components.
- Fault recorder with up to 40 x In fault capture
- Distance to Fault – fault location, using PAS™
- 32 digital counters for counting pulses from external sources and internal events.
- 16 programmable timers from 1/2 cycle to 24 hours for periodic recording and triggering operations on a time basis.
- 1-ms satellite-synchronized clock (IRIG-B time-code input¹).
- Backup power supply unit.
- 3 slots for "hot-swap" plug-in I/O/COM modules.
- 2-Mbyte non-volatile memory with battery backup; 256-Mbyte FLASH Memory for long-term waveform and data recording.

¹ PM180 N3 Version is equipped with IRIG-B synchronization port as standard

AC/DC Inputs

The PM180 is provided with a set of fully isolated AC/DC inputs for connecting to the AC feeders or station battery:

- Three isolated AC voltage inputs (up to 690VAC direct line-to-line input voltage)
- Four standard isolated AC current inputs with an extended input range up to 2000% overload (In = 5A input currents, to 100 Amps fault currents)
- Four optional additional isolated AC current inputs with an extended input range up to 4000% overload (In = 5A input currents, to 200 Amps fault currents)
- One AC/DC voltage input (up to 400VAC/300VDC) for monitoring the station battery

Digital and Analog I/O module Options

The PM180 has three I/O expansion slots for hot-swap plug-in I/O modules. The following I/O options are available:

- 16 DI x 3 – up to three 16-channel digital input modules: 16 optically isolated inputs per module; options for dry contacts, 10-30V, 20-250V wet inputs; programmable de-bounce time from 1 ms to 1 sec; free linkage to Sequence-of-Events recorder, Fault recorder, control setpoints, pulse counters and Energy/TOU subsystem.
- 8 RO x 3 – up to three 8-channel relay output modules: eight relays per module; unlatched, latched and pulse operations, failsafe operation for alarm notifications; programmable pulse width; direct remote relay control through communications.
- 4 AI/AO x 2 – up to two combined 4-channel AI/AO modules: four optically isolated analog inputs and four analog outputs per module with internal power supply; options for 0-1mA, ± 1 mA, 0-20mA, 4-20mA, 0-50mA and ± 10 V inputs and outputs; 200% overload currents for 0-1mA and ± 1 mA AI/AO (0-2 mA and ± 2 mA ranges are available).

Communications Options

The PM180 has extensive communications capabilities:

Standard communication ports

- Three independent universal serial communications ports (RS-232/485¹ and RS-485, up to 115,200 bps, MODBUS RTU/ASCII, DNP3.0 and IEC 60870-5-101 protocols)
- Infrared port (MODBUS RTU/ASCII and DNP3.0 protocols)
- Ethernet 10/100Base-T port (MODBUS/TCP, DNP3.0/TCP, IEC 60870-5-104 and IEC 61850 protocols (up to five non-intrusive simultaneous connections, Telnet service port)
- USB 1.1 port (MODBUS RTU protocol, 12 Mbps) for fast local communications and data retrieving

Optional communication ports

The PM180 has three expansion slots for hot-swap plug-in communication modules. In addition, each COM module is equipped with a serial RS-422/485 communication port. The following COM module options are available:

- Embedded 56K modem for communications through public telephone lines (MODBUS RTU/ASCII and DNP3.0 protocols) - **future**
- Embedded Cellular modem for communication through public cellular network (MODBUS/TCP and DNP3.0/TCP)
- 10/100Base TX or 100Base FX (optical port) backup Ethernet port (MODBUS/TCP, DNP3.0/TCP, IEC 60870-5-104 and IEC 61850 protocols, up to five non-intrusive simultaneous connections, Telnet service port)
- IEEE 802.11b/g backup wireless Ethernet port - WiFi (MODBUS/TCP, DNP3.0/TCP and IEC 61850 protocols, up to five non-intrusive simultaneous connections, Telnet service port) - **future**
- PROFIBUS DP - **future**
- IRIG-B for GPS time synchronization

Remote Displays

The PM180 can be ordered with a LED Remote Display Module (RDM180) or an LCD Remote Graphical Module (RGM180). Both have a fast RS-485 port and communicate with the PM180 via the MODBUS RTU protocol. Remote displays can be located at distances of up to 0.5 km from the device. The RGM180 can be ordered with an Ethernet 10/100Base-T port to communicate with the PM180 over a local network.

The RDM180 has two four-digit and one six-digit windows with bright red LEDs well suited for dark areas. It allows the user to view real-time RMS and harmonics measurements, status indication parameters, and perform basic setup operations when installing and servicing the device.

¹ RS-485 only in PM180 N3 Version

The RGM180 is equipped with a TFT color graphics LCD display with Touch Panel and has extensive dialog capabilities, allowing the user to view different fault and power quality information in a graphical form, such as waveforms, harmonic spectrum, phasors and data trends, review latest fault and power quality reports for fast fault analysis, and much more.

Upgradeable Firmware

The PM180 uses flash memory for storing device firmware. This allows upgrading of your device without replacing hardware components. New features can be easily added to your device by simply replacing firmware through any communication port.

Device Models

The expertmeter™ PM180 Series includes two models:

1. Power quality models are available with either an IEEE 1159 power quality option (standard), or an EN 50160 (special order) or a GOST13109 or GOST 32144-2013 compliance statistics options.
2. Each model option above can be ordered with Substation Automation System protocol IEC 61850

Firmware Versions

Use the following firmware references to check your device's options:

- V31.X4.XX - Basic fault + IEEE 1159 power quality recorder + IEC 61000-4-15 flicker
- V31.X5.XX - Basic fault + EN 50160¹ power quality recorder
- V31.X7.XX Basic Fault + GOST13109-97 + Flicker IEC 61000-4-15 + Harmonics IEC 61000-4-7
- V31.X8.XX Basic Fault + GOST 32144-2013 + Flicker IEC 61000-4-15 + Harmonics IEC 61000-4-7
- V31.1X.XX +IEC 61850 server option

¹ From firmware version V31.X5.28 – EN 50160 is user selectable, whether EN 50160:2007 or EN 50160: 2010 based on IEC 61000-4-30:2015 3rd ed.

Supplemental Documents

- BG0521 PM180 Installation Manual
- BG0527 PM180 MODBUS Reference Guide
- BG0524 PM180 DNP3 Reference Guide
- BG0523 PM180 IEC 61850 Reference Guide
- BG0591 PM180 IEC60870-5 Reference Guide
- BG0531 PM180 Bay Controller Unit – Application note
- BG0337 PAS Getting Started Guide
- BB0165 PM180 Fault Locator - Application Note

Chapter 2 Device Description

Controls and Indicators

Device Controls

The PM180 is entirely controlled either from the remote display module (RDM or RGM), or by using the supplemental PAS power analysis software package.

Indicator LEDs

The PM180 has three status indicator LEDs that show present device operation status and give diagnostics indication; one energy pulsing LED that output kWh/kvarh pulses, located on the attached Display; and COM port status LEDs that show present ports status and communications activity.

LED Name	Color	Status	Description
CPU	Green	Flashing 1 sec On, 1 sec Off	Device operational and is functioning normally.
		Flashing 2 flashes, 1 sec Off	Device is in the Service Mode and is not operational.
		Flashing 3 flashes, 1 sec Off	A critical error has occurred - the device is not operational. Device servicing is required. For more information, see Diagnostics Mode below.
MAIN POWER	Green	On	Voltage is supplied to the main power supply unit.
BACKUP POWER	Green	On	Voltage is delivered to the backup power supply unit.
kWh/kvarh	Red	Flash at user-programmed rate	The device measures imported (consumed) active and reactive energy. For information on defining the LED pulse rate, see Advanced Device Setup in Chapter 6.

Modes of Operation

The PM180 can run in the following modes:

Operational Mode

Operational Mode is the common operation mode. All device features are available.

When the device is in Operational Mode the CPU LED flashes for 1 second with a 1-second pause.

Energy Test Mode

Energy Test Mode tests the device energy measurement accuracy. All basic measurements are available; energy accumulators are not affected; setpoints operation, fault and power quality recorders are stopped. To put the device into the Energy Test Mode, see [Device Options Menu](#) in Chapter 3, or [Device Mode Control](#) in Chapter 10.

Service Mode

Service Mode is used for local upgrading of PM180 firmware. When the device enters Service Mode, the CPU LED briefly flashes 2 times with a 1-second pause.

In Service Mode, all device operations are stopped.

Diagnostics Mode

The device enters Diagnostics Mode when the internal diagnostics detects a critical error that affects the normal device operation. All device operations are stopped until the critical error is cleared. All communications ports are still available. See [Device Diagnostic Codes](#) in Appendix F for the list of diagnostic events that cause a critical error. See [Device Diagnostics](#) for more information on the PM180 built-in diagnostics.

When the device is in Diagnostics Mode, the CPU LED briefly flashes 3 times with a 1-second pause, and the RDM display shows a diagnostic message.

For more information on indication and clearing the device diagnostics, see [Status Information Display](#) in Chapter 3, [Viewing and Clearing Device Diagnostics](#) in Chapter 3, and [Viewing and Clearing Device Diagnostics](#) in Chapter 10.

Communicating with the PM180

Communication with the PM180 can be established independently and simultaneously through any communications port using the support PAS program supplied with the device or user application software. All communication ports are slave ports and have factory-preset parameters, such as baud rate, data format, and communications protocol that can be easily changed whenever desired.

COM1-COM3 Serial Communications (standard)

The PM180 has three standard serial communication ports COM1 through COM3 for communicating with the master workstations, RTUs, PLCs or PAS™@ PCs, and with an optional remote display. All serial ports can operate in the RS-485 two-wire mode. The COM1 is an RS-232/485¹ versatile port and can be directly connected to the RS-232 port of a PC or a controller. The COM2 ports can also be used for RS-422 four-wire communication. Local programming and upgrading the device firmware can be established by any communication port.

All ports are optically isolated and can operate at baud rates up to 115200 bps. Each port can be set up for any communication protocol supported by the PM180 independently from other ports. All ports are factory preset to 19200 bps, 8-bits/No-parity data format, and programmed for the Modbus RTU protocol.

The COM3 port has different connection terminals and is intended for communication with the Remote Display Module (RDM) or Remote Graphical Module (RGM). If the remote display is not used, the COM3 port can be used as a common RS-485 port.

See [Configuring Serial Ports](#) in Chapter 3 for information on how to set up serial ports in your device. For wiring diagrams, refer to the PM180 Installation Manual.

Note

The COM3 port DB15 pins 1 and 8 deliver 12VDC for powering the remote display module. Connecting the RS-485 wires to these terminals can cause permanent damage to your RS-485 port.

COM4 Infrared Port (optional)

The PM180 has an optical infrared (IR) port for local retrieving data via a hand-held unit or a portable PC. The IR port can be equipped with an IEC- or ANSI-compatible optical head.

The IR port is identified in the PM180 as the COM4 port. It is factory preset to 19200 bps, 8-bits/No-parity data format, and programmed for the MODBUS RTU protocol.

¹ In PM180 N3 Version RS-485 is only available on COM1

The IR port is only available on the RGM180 attached to the IED.

COM5 Port (optional)

The following plug-in modules are identified as COM5 port:

- Embedded 56K modem for communications through public telephone lines (MODBUS RTU/ASCII and DNP3.0 protocols). - **future**
- Embedded Cellular modem for communication through public cellular network (MODBUS/TCP and DNP3.0/TCP)
- PROFIBUS DP - **future**

USB Port (standard)

A USB node port is intended for local communications with the support PAS software. It is directly connected to your PC's USB port using the supplied USB cable. The USB communications does not require any settings. Just connect your PC to the PM180 USB port and install the supplied USB driver (see [Installing the USB Driver](#) in Chapter 6). The USB communications is ten times faster than the serial communications can provide at a maximum baud rate.

Ethernet Port (standard)

A 10/100Base-T Ethernet port provides a direct connection of the PM180 to a local area network through the TCP/IP protocols. The device has three onboard TCP servers configured for the Modbus/TCP (at TCP port 502), DNP3.0/TCP (at TCP port 20000) and IEC 60870-5-104 (at TCP port 2404) communications. The TCP servers can support up to 5 simultaneous connections with MODBUS/TCP, DNP3.0/TCP and IEC 60870-5-104 client applications.

Connection through the Ethernet port does not require device identification. The PM180 responds to any device address and returns the received address in the response message.

Note

To provide simultaneous file services for all ports, the PM180 keeps independent file pointers for each communications port. For a TCP port, the PM180 holds separate file pointers for each active TCP socket. The TCP server automatically closes a connection if a socket is idle for more than 5 minutes. There is no guarantee that a new connection is established at the same socket, so do not make any assumptions regarding the current file status when starting a new connection from your application. Always initialize a file pointer to a record from where you expect to begin reading a file. For more information, see "File Transfer" in the PM180 MODBUS Communications Guide.

Ethernet Port (optional)

A second Ethernet port for LAN backup is available in plug-in module. As default the standard Ethernet port is active, if this link is down the second optional Ethernet port will switch on automatically to provide LAN access through it. The second Ethernet port can be either wired LAN 10/100Base T, either optical 100Base FX either wireless IEEE 802.11 b/g.

It provides a direct connection of the PM180 to a local area network through the TCP/IP protocols. The device has two onboard TCP servers configured for the MODBUS/TCP (at TCP port 502) and DNP3.0/TCP (at TCP port 2000) communications. The TCP servers can support up to 5 simultaneous connections with MODBUS/TCP and DNP3.0/TCP client applications.

Connection through the Ethernet port does not require device identification. The PM180 responds to any device address and returns the received address in the response message.

CELLULAR Port (optional)

A 2G/3G Cellular modem port provides a direct connection of the PM180 to a public area cellular network through the TCP/IP protocols. The device has two onboard TCP servers configured for the Modbus/TCP (at TCP port 502) and DNP3.0/TCP (at TCP port 20000) communications. The TCP servers can support up to 5 simultaneous connections with MODBUS/TCP and DNP3.0/TCP client applications.

Connection through the CELLULAR port does not require device identification. The PM180 responds to any device address and returns the received address in the response message.

Using the RDM and RGM

The Remote Display Module (RDM) or Remote Graphical Module (RGM) is connected to the device's COM3 port using the RS-485 two-wire connection. The COM3 port connector has additional isolated 12VDC output terminals to power the RDM directly from the PM180. For information on using the RDM, see Chapter 3 "[Using the RDM](#)".

The remote display modules communicate with the PM180 using the MODBUS RTU protocol. Both the COM3 port and the RDM/RGM RS-485 port are preset at the factory to 19200 bps, 8-bits/No-parity, address 1, and run the MODBUS RTU protocol. The baud rate can be increased up to 115200 bps (depending on the communications quality) through the RDM or service Terminal program.

Using PAS

PAS is the support software supplied with the PM180 that gives the user basic tool for programming the device, performing remote control operations, monitoring real-time measurements, retrieving and analyzing historical data files, reviewing fault and power quality reports, and more.

PAS can communicate with the devices through any PM180 port using the MODBUS RTU, MODBUS ASCII and DNP3.0 protocols.

For information on installing and using PAS, see Chapter 5 "[Using PAS](#)".

Device Inputs

AC Inputs

The AC voltage and current input terminals are connected to the internal device circuits through input transformers that isolate the device from external wiring.

Voltage Inputs

The device has three transformer-isolated and one high-impedance voltage inputs (direct 690V RMS phase-to-phase voltage, $\times 120\%$ overload). Voltage channels are designated as V1 through V4.

The secondary voltage rating and primary to secondary voltage ratio (PT ratio) of the external potential transformers must be specified in your device to provide correct voltage measurements. For more information on specifying voltage input ratings in your device, see [Basic Device Setup](#) in Chapter 6.

The secondary rating of the voltage inputs is used as a reference for calculating thresholds for the power quality and fault triggers.

The device can also be provided with 4 additional voltage inputs, using TRM module, to measure fast transient high voltage phase/neutral-to-ground.

Current Inputs

The device is provided with current input transformers with either 5A or 1A rated current.

All models are shipped with four extended range 100A current transformers (5A rated current) as a standard.

To expand the dynamic range of the current inputs, current measurements are performed in two measurement ranges regardless of the device model: one is the standard current range up to 20A/10A for precise power, energy and harmonics measurements, and the second is the extended current range up to 100A, used for measuring and recording fault currents.

The device can also be provided with 4 additional current inputs, using DFR module, to measure independent fault current up to $40 \times I_n$ (200A @ $I_n=5A$)

For more information on specifying input ratings in your device, see [Basic Device Setup](#) in Chapter 6.

Sampling

8 AC channels (4 voltages and 4 currents) are continuously and simultaneously sampled at a rate of 256 samples per cycle (12.8 kHz at 50Hz or 15.36 kHz at 60Hz).

4 additional AC voltage channels are continuously and simultaneously sampled at a rate of 512 or 1024 samples per cycle.

The sampling rate is precisely synchronized with the power frequency. The reference frequency signal is taken from one of the phase voltage inputs V1-V3, band-pass filtered, and then sampled at 12.5 MHz providing a 0.0004% cycle measurement error.

Waveform Tracing

The sampled waveforms are stored to the circular trace buffer whose depth is sufficient to provide up to 20 pre-fault cycles for the waveform recorder. The waveform recorder is synchronized with the sampling circuitry and can store unlimited number of post-event cycles. The length of the captured waveforms is only restricted by the size of the allocated logging memory.

VDC Input

One high-impedance DC voltage input (300VDC range) V4, is normally intended for monitoring the substation battery. It is sampled at a rate of 2 samples per cycle (each 8 or 10 ms) and synchronized to the AC sampling circuitry.

The waveform recorder can provide recording of VDC data simultaneously with the AC input channels that allows testing the behavior of the substation battery under load at the time of a fault.

The VDC drop can also trigger a setpoints to provide an external alarm indication through a relay output or communications.

Digital Inputs

The PM180 can monitor up to 3 removable 16-channel digital input modules with a total of 48 inputs. The modules may be ordered with input options for dry contacts, or 24V, 125V and 250V wet inputs.

All digital inputs are sampled at a rate of 16 samples per cycle and synchronized to the AC sampling circuitry. This gives time stamping of the input transitions with a 1-ms resolution at 60 Hz, or 1.25-ms at 50 Hz.

Digital inputs have a programmable debounce time from one to 100 milliseconds in groups of eight inputs. Each input can be independently linked to any device counter, Energy/TOU system register, setpoints, Fault recorder, and Sequence-of-Events recorder.

The device waveform recorder provides synchronous recording of the 48 digital input channels together with the AC waveforms making it easy to correlate the operation of the station protection relays at the time of a fault.

Analog Inputs

The PM180 monitors up to 12 analog input (AI) channels, which may be used for measuring DC and low frequency currents and volts.

The following plug-in AI modules may be ordered with the device:

- 4-channel optically isolated 4AI/AO modules with optional ranges of 0-1 mA, ± 1 mA, 0-20 mA, or 4-20 mA, 0-50 mA or ± 10 V. The 0-1 mA and ± 1 mA analog inputs can measure 200% overload currents up to 2 mA and ± 2 mA.

The PM180 may be equipped with three 4AI/AO modules.

The scan time for regular analog inputs is 2 cycles (32 ms at @ 60Hz and 40 ms @ 50Hz). AI readings and triggers are updated each 1/2-cycle.

Each analog input can be independently scaled to provide true readings in the user-defined engineering units (see [Programming Analog Inputs](#) in Chapter 6).

NOTES:

1. If you use both 4AI/AO and 8AI modules in the same device, put the 4AI/AO module in slots with lower numbers, i.e., into the left side slots.
2. If you use regular 4AI/AO modules and fast 8AI modules, the regular inputs are scanned at a usual rate.

Device Outputs

Analog Outputs

The PM180 supports up to three removable 4AI/4AO modules with a total of 12 analog output channels that can output DC currents proportional to the measured analog quantities. All outputs

are optically isolated and have an internal power supply. The AI modules may be ordered with 0-1mA, ± 1 mA, 0-20mA, or 4-20mA output current. The 0-1mA and ± 1 mA analog outputs provide 200% overload currents up to 2 mA and ± 2 mA.

Update time for analog outputs is 2-cycles (32 ms at @ 60Hz and 40 ms @ 50Hz).

Each analog output can be independently scaled to provide the desired engineering scale and resolution (see [Programming Analog Outputs](#) in Chapter 6).

Relay Outputs

The PM180 provides up to 24 digital outputs through three plug-in 8-channel relay output modules. Each module has eight electro-mechanical relays 2-contact SPST Form A.

The following table shows timing characteristics of the relays and their expected lifetime.

Characteristic	Form A Relays
Operate time	10 ms
Release time	5 ms
Bounce time	1 ms
Mechanical endurance	10,000,000 operations
Electrical endurance (8A/250V)	50,000 operations

Each relay is independently programmable and operates in latched, unlatched, pulse or KYZ mode. Relay operations can be inverted so that the relay is energized in its non-active state and de-energized when it is operated. This mode, known as “failsafe” mode, is used for signaling purposes to send alarms when the device is not operational either due to a fault or due to loss of power.

Latched and Unlatched Operation

Latched and unlatched mode of operation concerns local relay commands issued from the control setpoints.

In unlatched mode, a local setpoints command sent to the relay is automatically cleared; the relay is released when all setpoints linked to the relay return to non-operated state.

In latched mode, the operated relay is not released automatically when the conditions that caused the relay to operate are no longer present. To release a latched relay, an explicit release command must be sent either from a separate setpoint, or through communications. If the relay is locked in the operated state by a remote command, the local release command only clears the internal latch and the relay stays in operated state until the remote command is removed.

Pulse and KYZ Operation

Pulse mode causes a relay to produce a pulse with a predefined duration in response to a local or remote relay command. After a pulse is expired, the command is automatically cleared and the relay is held up in released state for at least pulse width time before the next command is accepted.

The programmable pulse width is selected from 10 ms to 1 sec. The device scans all relays in 1/2-cycle time intervals. This means that the actual pulse width is a multiple of the 1/2-cycle time rounded to the nearest larger value. The programmable pulse width does not include the relay operate and release times.

In KYZ mode, every operate command changes the present state of a relay to the opposite state producing a transition pulse, and the relay is held up in this state for at least pulse width time before the next command is accepted. KYZ mode is commonly used with Form C relays to signal pulses by alternation of the two contact pairs.

Pulse and KYZ relays can be directly linked to the internal pulse sources to output energy or time interval pulses.

Remote Commands

A remote operate command forces a latched or unlatched relay to move to its active state. The relay is held in active state until the command is removed by a remote release command. The remote release command also removes the local commands that hold a latched relay in active state.

A remote operate command sent to a pulse or KYZ relay forces the relay to produce a pulse or changes its state. A remote release command sent to a pulse or KYZ relay has no effect since the operate command is cleared automatically for these relays.

Retentive Relays

Latched relays can be set to operate in retentive mode. Retentive mode affects the behavior of the relay after loss of power.

After restoring power, all non-retentive relays are in inactive state until local conditions are reevaluated. All active remote commands for non-retentive relays are cleared.

Retentive relays retain their status after restoring power, and all active remote commands that were issued before loss of power are still effective.

Critical Faults

When a critical error is detected by the device diagnostics, all relays are released regardless of their operation mode, and all remote relay commands are removed.

Metering

RMS Measurements

All RMS quantities are based on 1/2-cycle true RMS measurements performed over 64 samples of the acquired waveforms. The 1/2-cycle quantities are values (normally, RMS volts, RMS currents and unbalances) measured over one cycle and updated each half cycle (IEC 61000-4-30). This allows fast response to power quality and fault events.

RMS Trace

The PM180 handles a circular RMS trace buffer that stores the last forty 1/2-cycle RMS, unbalance, zero-sequence, VDC and frequency readings. This allows the data recorder to provide 1/2-cycle trending of up to 20 pre-fault cycles when it is triggered from the Power Quality or Fault recorder.

The following table lists parameters that are available for pre-fault tracing.

Parameter	Label
Phase-to-neutral volts	V1, V2, V3
Phase-to-phase volts	V12, V23, V31
Auxiliary volts	V4
Standard range currents	I1, I2, I3, I4
Standard range neutral current	In
Extended range currents	I1x, I2x, I3x, I4x
Extended range neutral current	Inx
Voltage zero sequence	V ZERO-SEQ
Standard range current zero sequence	I ZERO-SEQ
Extended range current zero sequence	Ix ZERO-SEQ
Voltage unbalance	V UNB%
Standard range current unbalance	I UNB%
Extended range current unbalance	Ix UNB%
DC voltage	VDC
Power frequency	Frequency

Data logs #13 (fault data trend) and Data logs #14 (PQ data trend) are internally linked to the RMS trace buffer. The number of pre-fault cycles for data trending is defined when configuring the Power Quality and Fault recorders. See [Configuring the Power Quality Recorder](#) and [Configuring the Fault Recorder](#) in Chapter 7.

Harmonic Measurements

The PM180 provides harmonic measurements on four voltage channels V1-V4 and four standard range (20A/10A) current channels I1-I4. To avoid erroneous harmonic readings when the high fault currents saturate current channels, the harmonics registers are not updated at the time of the fault.

The FFT analysis is performed over a 10-cycle waveform for 50Hz and 12-cycle waveform for 60Hz system, sampled at a rate of 256 samples per cycle. This gives spectrum components up to the 63rd harmonic.

The following table lists harmonic quantities provided by the device.

Parameter	Label
Total Harmonics	
Voltage THD	V1 THD - V4 THD
Current THD	I1 THD - I4 THD
Current TDD	I1 TDD - I4 TDD

Parameter	Label
Current K-factor	I1 KF - I4 KF
Voltage Crest-factor	V1 CF - V4 CF
Current Crest-factor	I1 CF - I4 CF
Total Interharmonics	
Voltage THD	V1 THD/I - V4 THD/I
Current THD	I1 THD/I - I4 THD/I
Individual Harmonics	
V1 Odd/even-harmonic distortion	V1 %HD1 - V1 %HD63
V2 Odd/even-harmonic distortion	V2 %HD1 - V2 %HD63
V3 Odd/even-harmonic distortion	V3 %HD1 - V3 %HD63
V4 Odd/even-harmonic distortion	V4 %HD1 - V4 %HD63
I1 Odd/even-harmonic distortion	I1 %HD1 - I1 %HD63
I2 Odd/even-harmonic distortion	I2 %HD1 - I2 %HD63
I3 Odd/even-harmonic distortion	I3 %HD1 - I3 %HD63
I4 Odd/even-harmonic distortion	I4 %HD1 - I4 %HD63
V1 Odd-harmonic voltage	V1 H01 - V1 H63
V2 Odd-harmonic voltage	V2 H01 - V2 H63
V3 Odd-harmonic voltage	V3 H01 - V3 H63
V4 Odd-harmonic voltage	V4 H01 - V4 H63
I1 Odd-harmonic current	I1 H01 - I1 H63
I2 Odd-harmonic current	I2 H01 - I2 H63
I3 Odd-harmonic current	I3 H01 - I3 H63
I4 Odd-harmonic current	I4 H01 - I4 H63
Three-phase total odd-harmonic kW	kW H01 - kW H63
Three-phase total odd-harmonic kvar	kvar H01 - kvar H63
Three-phase total odd-harmonic PF	PF H01 - PF H63
Symmetrical Components	
Positive-sequence voltage	V PSEQ
Negative-sequence voltage	V NSEQ
Zero-sequence voltage	V ZSEQ
Negative-sequence voltage unbalance	V NSEQ UNB%
Zero-sequence voltage unbalance	V ZSEQ UNB%
Positive-sequence current	I PSEQ
Negative-sequence current	I NSEQ
Zero-sequence current	I ZSEQ
Negative-sequence current unbalance	I NSEQ UNB%
Zero-sequence current unbalance	I ZSEQ UNB%
Fundamental Phasors	
Voltage magnitude	V1 Mag - V4 Mag
Current magnitude	I1 Mag - I4 Mag
Voltage angle	V1 Ang - V4 Ang
Current angle	I1 Ang - I4 Ang

The device provides individual voltage and current harmonic measurements both in percent of the fundamental component, and in corresponding engineering units. Quantities in engineering units are calculated only for odd harmonics.

Angles for phasor vectors are given relative to the V1 phase voltage.

Aggregation Intervals

The device provides electrical measurements using a number of fixed aggregation time intervals from 1/2 cycle to 2 hours. The demand measurements use programmable aggregation intervals of up to 2.5 hours. The following table shows aggregation intervals available for different electrical quantities.

Parameter	1/2 cycle	1 cycle	200 ms	1 sec	3 sec	10 min	2 hours
RMS volts and currents	x	x	x	x	x	x	x
Powers		x		x	x		
Zero-sequence	x	x	x	x	x	x	x
Unbalance	x	x	x	x	x	x	x
DC Voltage	x	x	x	x	x	x	x
Frequency		x	x	x	10 sec	x	x
Total Harmonics/Interharmonics			x	x	x	x	x
Individual Harmonics			x				
K-factor			x	x	x	x	x
Crest factor			x		x	x	x

Parameter	1/2 cycle	1 cycle	200 ms	1 sec	3 sec	10 min	2 hours
Symmetrical components			x				
Phasors			x				

The 200 ms RMS and unbalance quantities are integrated over a 10-cycle time for 50 Hz and 12-cycle time for 60 Hz power system. The data for the 3 sec time interval is aggregated from fifteen 200 ms time intervals. All RMS quantities aggregated from lower time intervals represent true RMS readings over the entire aggregation interval.

Demands

Demand measurements are provided for volts, amps, total harmonics and powers. Two different demand measurement techniques are used: block interval demand and sliding window demand.

Block Interval Demand

The block interval demand is calculated by aggregation of measurements over contiguous and non-overlapping fixed time intervals. Volts, amps and total harmonic demands are produced by averaging 1 sec RMS aggregates. Power demands are evaluated using integration of energies and averaging power over the demand time interval.

For volt, ampere and total harmonic demands, the demand period time is programmed from 1 second to 2.5 hours (see [Advanced Device Setup](#) in Chapter 6). For power demands, the demand period can be selected from 1 min to one hour.

Sliding Window Demand

The sliding window (rolling) demand technique is applied to power demands. The sliding window demand is calculated by averaging block interval demands over a number of adjacent demand intervals, which produce a sliding window. The number of time intervals for a sliding window can be selected from 1 to 15. When the present block demand interval expires, the sliding window moves one step forward by replacing the oldest entry with the most recent calculated block interval demand.

Accumulated and Predicted Demands

For power demands, the device provides an indication of two additional parameters: the accumulated block interval demand and predicted sliding window demand. Both accumulated and predicted demands can be effectively used for load shedding on the substation feeders.

The accumulated demand represents the relative energy accumulated from the beginning of the present demand interval and expressed in power units. It grows from zero at the beginning and up to the final block demand at the end of the demand interval. If the accumulated demand exceeds the allowed demand at any point, the final block interval demand is more than the present accumulated demand (or equal if the load is disconnected).

The predicted demand shows the expected sliding window demand value at the end of the present demand interval, assuming that the load does not change. The predicted demand reflects load changes immediately as they happen.

Power demands are calculated for all device energy accumulators, including the Summary and TOU energy registers (see [Energy Metering](#) below).

The following table shows demand quantities provided by the device.

Parameter	Block Demand	Sliding Demand	Accumulated Demand	Predicted Demand
Volt demands	x			
Ampere demands	x			
Voltage THD demand	x			
Current THD demand	x			
Current TDD demand	x			
kW demand (import and export)	x	x	x	x
kvar demand (import and export)	x	x	x	x
kVA demand	x	x	x	x
Summary energy demand (16 configurable registers)	x	x	x	

Maximum Demands

Every demand parameter is provided with the maximum demand register, which contains a time-stamped peak demand value recorded since the last reset. Maximum power demand registers are linked to the corresponding sliding demand source registers. If you wish to use block interval

demands instead of sliding window demands as a source, set the number of the block intervals in the sliding window to 1.

For the TOU demand registers, the device allows automatic recording (profiling) of the daily and monthly maximum demands to the data log together with the TOU energy readings.

Energy Metering

The PM180 provides true four-quadrant energy measurements for kWh imported and exported, kvarh imported and exported, and kVAh, with Class 0.2 ANSI C12-20:2002 or Class 0.2S IEC 62053-22:2003 accuracy. Net and total energy measurements for kWh and kvarh, and volt-hours and ampere-hours calculations are provided.

The device provides nine-digit energy counters by default. You can set the counters to have fewer digits by changing the default energy roll value in your device (see [General Setup Device Option](#) in Chapter 6).

Energy Pulses

The PM180 outputs energy pulses through relay contacts with a user-selectable pulse rate (see [Producing Energy Pulses](#) and [Programming Relay Outputs](#) in Chapter 6). The pulse type (complete pulse or KYZ pulse), pulse width and polarity are freely programmable.

Energy Pulse LEDs

The PM180 has two pulse LEDs on the front that provide energy pulsing for imported kWh and kvarh.

The LED pulse rate (pulse constant) is user-selectable (see [General Setup Device Option](#) in Chapter 6) and is programmed in secondary units. It does not depend on the ratings of the external transformers. The LED pulse rate is set at the factory to 0.1 Wh/pulse corresponding to one equivalent disk revolution.

The energy pulse LEDs are used for testing device accuracy by the external control equipment through pulse readers. In order not to affect the energy accumulators, the device should be put into the Energy Test Mode where the energy accumulators are disconnected from the power sources. Energy Test Mode also prevents erroneous setpoint operation and recording faults and power quality events when the test volts and currents are applied to the device. For information on entering the Energy Test Mode, see [Device Mode Control](#) in Chapter 10 and [Device Options Menu](#) in Chapter 3.

Summary Energy Registers

The PM180 provides 16 summary (totalization) energy registers and 16 parallel demand registers that can be linked to any internal energy source, or to any external pulse source that delivers energy pulses through the device digital inputs (see Chapter 8 [Totalization Energy and TOU Registers](#)).

Each summary register can be configured to accumulate energies from multiple sources using arithmetic addition and subtraction. A summary register is allowed to be linked to another summary register to provide more comprehensive energy calculations.

Time-of-Use

The PM180 TOU system handle a 10-year calendar with up to 16 types of days and up to eight tariff changes per day in each daily profile.

The device provides 16 TOU energy and 16 parallel maximum demand registers that receive data from the corresponding summary registers. Each TOU energy and TOU maximum demand register stores the accumulated energy and corresponding peak demands for up to 16 tariffs. See Chapter 8 ["Totalization Energy and TOU Registers"](#) for information on how to configure the TOU registers and define the tariff scheme in your device.

The device allows automatic daily and monthly profiling of the TOU energy readings and TOU maximum demands to the data log files. Data log files #15 and #16 are dedicated to the TOU system profile log and can be configured to automatically record TOU daily and monthly profiles (see [Configuring Data Log Files](#) in Chapter 7).

Instrument Transformer Correction

Ratio and phase angle error correction can be applied to external CTs and PTs to achieve overall metering installation accuracy, or be used in any metering installation to optimize the accuracy of the metering data.

The user can program up to both ratio correction and phase angle error curves covering the typical transformer operating range.

The PM180 is able to calculate the transformer errors dynamically based on the transformer performance characteristics and the actual CT current and PT voltage signals appearing at the meter, to interpolate to the actual measured operating point and to apply the interpolated error corrections to the meter calculations.

See [Instrument Transformer Correction Setup](#) on how to program the ratio correction factors and phase angle errors for external CTs and PTs and enable correction in the meter. See [Device Options and Mode Control](#) on how to enable and disable correction in the meter via the front display.

NOTES

1. When transformer correction is enabled, it is applied to all instrumentation, billing and power quality calculations and waveforms.
2. Transformer correction does not affect test LED pulse outputs.
3. Transformer correction is not operational in test mode regardless of the option's status.

Monitoring

Substation Battery

The substation battery is normally connected to the DC voltage input terminals to provide battery voltage measurements. Refer to the PM180 "Installation Manual" for wiring diagrams.

See [VDC Input](#) above for information on metering and monitoring DC voltage in your device.

Memory Backup Battery

The hardware circuit monitors the status of the memory backup battery. When the battery level drops below the minimum allowed threshold, the red MEM.BAT.LOW LED on the front of the device is lit up, indicating that the battery should be replaced.

Power Supply

The status of the two power supply units is indicated on the front of the device by two green LEDs: MAIN POWER and BACKUP Aux. POWER. The LEDs are lit up when the supply voltage is present on the device terminals.

Logical Controller

The embedded logical controller allows monitoring any measured quantity or external contacts to provide indication, counting and recording events when the monitored value exceeds the predefined threshold or when status transitions are detected on the device inputs. See [Using Control Setpoints](#) in Chapter 6 for information on programming the logical controller.

The logical controller launches the Waveform recorder and Data recorder to record the input waveforms and measured quantities at the time of the event. Control setpoints can also be linked to the Event recorder and Sequence-of-Events recorder to record setpoint transition events into the event log files.

For Bay Controller Unit application see BG0xxx PM180 Bay Control Unit - Application Note

Recording

Event Recorder

The Event recorder automatically records time-tagged self-supervision events related to configuration changes, resets and device diagnostics. The logical controller can also be programmed to trigger the Event recorder in order to put the events monitored through programmable setpoints into the event report. See [Configuring the Event Recorder](#) in Chapter 7 for more information on programming the Event recorder.

Sequence-of-Events Recorder

The Sequence-of-Events recorder automatically records time-tagged fault events and programmable digital inputs, relay outputs and setpoint transition events. See [Configuring the Sequence-of-Events Recorder](#) in Chapter 7 for more information on programming the Sequence-of-Events recorder.

Power Quality Recorder

Depending on the order, the PM180 may be supplied with either the IEEE 1159 Power Quality recorder, or EN50160 Power Quality recorder, or GOST 32144-2013 Power quality recorder.

The recorder continuously monitors voltage inputs and records time-tagged disturbances and faults into the power quality event log. The EN 50160¹ Power Quality recorder also provides the EN 50160 statistics counters for standard compliance reports, and long-term harmonics survey statistics. All power quality triggers have programmable thresholds and can be adjusted for specific applications.

The IEEE 1159 Power Quality recorder automatically classifies disturbance events by IEEE 1159 disturbance categories. The IEEE 1159 Power Quality reports can also combine traditional IEEE 1159 voltage disturbance categories with fault current disturbances and protective relay fault information for complete "cause and effect" fault and disturbance analysis.

The Power Quality recorder is programmed to trigger the Waveform recorder and Data recorder to record input waveforms and long-duration RMS trends during the time of the disturbance. See [Configuring the IEEE 1159 Power Quality Recorder](#) and [Configuring the EN50160 Power Quality Recorder](#) in Chapter 7 for more information.

Fault Recorder

The programmable Fault recorder records time-tagged fault events into the fault event report. It can be triggered externally through any digital input or internally from the embedded fault detector. The internal fault detector can automatically detect different fault categories using the device's own sub-cycle measurements. The fault triggers have programmable thresholds and hysteresis that can be adjusted for specific substation conditions.

The Fault recorder can be programmed to trigger the Waveform recorder and Data recorder to record input waveforms and long-duration RMS trends during the time of the fault. See [Configuring the Fault Recorder](#) in Chapter 7 for more information.

Fast Transient Recorder

The fast transient recorder is provided with the TRM – transient add-on module. It can detect impulsive and low frequency oscillatory transient overvoltages with peaks up to 2kV and durations from 20 microseconds.

¹ From firmware version V31.X5.28 – EN 50160 is user selectable, whether EN 50160:2007 or EN 50160: 2010 based on IEC 61000-4-30:2015 3rd ed.

The recorder does not require any special setup above a conventional PQ recorder setup for transient overvoltages. Waveform log #6 is especially dedicated for fast transient waveforms. It automatically stores 2-cycle voltage waveforms sampled at a rate of 1024 samples/cycle or 4-cycle voltage waveforms sampled at a rate of 512 samples/cycle whenever a transient overvoltage is detected.

Unlike a basic transient recorder provided with the PM180 that detects and records transient voltages between phase conductors and a neutral terminal (in 4LN3 and 3LN3 configurations), or between two phase conductors (in line-to-line configurations), the fast transient recorder detects transient voltages between phase conductors and a ground terminal and between the neutral and a ground terminal regardless of a wiring configuration.

See the PM180 Installation Manual for the terminal location and wiring diagrams. To help you check your voltage connections, the PM180 provides 2 or 4-cycle phase RMS voltages V1x through V3x, and 2 or 4-cycle neutral voltage V4x relative to the ground terminal that you can monitor via PAS.

Phasor Measurement Unit - PMU

The PMU is implemented as an add-on card integrated in one assembly with the fast transient recorder module. Both may be ordered in a single package or separately.

The PM180 firmware version must be at least V31.XX.28

Voltage and current signals are delivered from the common AC inputs via the PM180 backplane. 400 Hz cut-off anti-aliasing filters are applied on voltage and current inputs to reject undesirable high-frequency signal components.

Measuring Techniques

Synchrophasor Estimation

The PMU calculates and reports synchrophasor estimates as defined and described in IEEE C37.118.1 Clause 4.

The estimates include three-phase voltage and current synchrophasors calculated from the input signal waveforms synchronized to an absolute time reference, followed by complex multiplication with the nominal frequency carrier, i.e., multiplication of the input by the quadrature oscillator (sine and cosine).

All measurements are made on a common time base and related to the system nominal frequency, so the phase angle measurements are directly comparable. Differences in the actual frequency are included in the phase angle estimation. A precise time reference clock is used to provide the UTC time to determine the phase angle.

The filtering associated with the computation of the synchrophasors rejects the undesirable signal components appearing at the PMU inputs by the filter attenuation. The phasor estimation algorithm uses fixed length two-cycle triangular weighted FIR filter that is not changed for different PMU reporting rates. In order to simplify time stamp generation and phase compensation, the algorithm uses an odd number of samples (filter taps). This allows conversions and filtering to use a sample time stamp at the center of the window without adjustment.

The phasor calculations use fixed frequency sampling at a rate of 25 samples/cycle, which corresponds to $25 \times 50 = 1250$ samples/s for a 50 Hz system or $25 \times 60 = 1500$ samples/s for a 60 Hz system.

The complex synchrophasor estimate $X(i)$ at the i -th sample time is calculated as follows:

$$X_{\text{Re}}(i) = \frac{\sqrt{2}}{\text{Gain}} \times \sum_{k=-N/2}^{N/2} x_{(i+k)} \times \cos(2\pi f_0 \times \Delta t \times (i+k))$$

$$X_{\text{Im}}(i) = -\frac{\sqrt{2}}{\text{Gain}} \times \sum_{k=-N/2}^{N/2} x_{(i+k)} \times \sin(2\pi f_0 \times \Delta t \times (i+k))$$

$$\text{Gain} = \sum_{k=-N/2}^{N/2} W_{(k)}$$

Where:

$X_{\text{Re}}(i)$ - a real component of the synchrophasor estimate at the i -th sample time

$X_{\text{Im}}(i)$ - an imaginary component of the synchrophasor estimate at the i -th sample time

f_0 - the nominal power system frequency (50 Hz or 60 Hz)

$\Delta t = 1/\text{sampling frequency}$

$N = 48$ - the FIR filter order

$x_{(i)}$ - waveform sample at time $t = i \times \Delta t$, where the time $t=0$ coincides with 1 s rollover

$W_{(k)}$ - low pass FIR filter coefficients

The FIR filter coefficients $W(k)$ are defined as follows:

$$W(k) = \left(1 - \frac{2}{N+2} |k|\right)$$

Where:

$k = -N/2$ to $N/2$

N - filter order, $N = (25 - 1) \times 2 = 48$ at a 25 samples/cycle sampling frequency.

The synchrophasor estimate at the i -th sample time in polar form is calculated as follows:

$$X(i) = \sqrt{X_{\text{Re}}^2(i) + X_{\text{Im}}^2(i)}$$

$$\Theta(i) = \arccos(X_{\text{Re}}(i) / X(i))$$

Where:

$X(i)$ is the magnitude of the i -th phasor estimate

$\Theta(i)$ is the angle of the i -th phasor estimate

Under this definition, $i \times \Delta t$ is the offset, i.e., the instantaneous phase angle, relative to a cosine function at the nominal system frequency synchronized to UTC. A cosine has a maximum at $t = 0$, so the synchrophasor angle is 0 degrees when the maximum of $x_{(i)}$ occurs at the UTC second rollover, and -90 degrees when the positive zero crossing occurs at the UTC second rollover.

As long as the sample times are compensated for input delays, the time stamp at the center of the window produces an estimate whose phase follows the actual power system frequency and does not need further phase or delay correction. It does require magnitude correction for off-nominal frequency that is applied to the final phasor based on the frequency estimate. The magnitude is compensated by dividing by a sine at the actual signal frequency with an additional factor of 1.625 to increase compensation, as defined in IEEE C37.118.1 Clause C5.1:

$$\hat{X}(i) = X(i) / (\sin(\pi(f_0 + 1.625 \Delta F(i)) / 2f_0))$$

Where: $\Delta F(i)$ = deviation of frequency from nominal computed at point i .

Frequency and ROCOF Estimation

The frequency is computed as the first derivative of the synchrophasor phase angle, and ROCOF is computed as the second derivative of the same phase angle.

The frequency and ROCOF estimates are based on positive sequence synchrophasors calculated using the symmetrical components transformation. Since phase angle changes relative to the difference between the actual frequency and the nominal frequency, this approach yields the offset from nominal.

The frequency and ROCOF estimation at the i -th phase estimate are calculated upon the equations given in IEEE C37.118.1a Clause C4:

$$\Delta F(i) = [\Theta(i+1) - \Theta(i-1)] / [4\pi \times \Delta t]$$

$$DF(i) = [\Theta(i+1) + \Theta(i-1) - 2\Theta(i)] / [2\pi \times \Delta t^2]$$

Where: $\Theta(i)$ is the angle of the i -th positive sequence estimate $X(i)$, and $\Theta(i+1)$ and $\Theta(i-1)$ are the angles of the phasor estimates following and preceding the i -th phasor estimate.

Measurement Time Synchronization

The PMU should be provided with a reliable and accurate GPS time source, that can provide time traceable to UTC so all measurements are synchronized to UTC time with accuracy sufficient to meet the requirements of IEEE C37.118.1.

For each measurement, the PMU assigns a time tag that includes the time and time quality at the time of measurement. The time tag can resolve time of measurement at 1- μ s accuracy.

The time status includes time quality that clearly indicates traceability to UTC, time accuracy, and leap second status. Time and time quality for reporting and recording are derived from the PMU time tag and converted to the format and content as required.

Reporting Rates

The PMU supports data reporting at sub-multiples of the nominal system frequency. The actual reporting rate is user selectable.

The available rates are listed in the following table.

System frequency	50 Hz					60 Hz												
Reporting rates (frames/s)	1	2	5	10	25	50	1	2	3	4	5	6	10	12	15	20	30	60

PMU Communications

IEC 61850 Communications

PMU Data Model

Synchrophasor data transfer in the context of IEC 61850 uses IEEE C37.118 to IEC 61850 mapping mechanism defined in IEC 61850-90-5.

PMU is modeled as a dedicated logical device within the PM180 IED. The detailed PMU data model is shown as a part of the ICD definition file in Annex A.

The PMU logical device is responsible for the publishing of the synchrophasor measurements as defined in IEEE C37.118.2. It includes:

- a) MMXU measurement logical node that represents voltage and current synchrophasor data, frequency and ROCOF measurements; the new data object of HzRte was added to the MMXU logical node to accommodate the ROCOF data.
- b) LTIM time management logical node that gives indication of the local time configuration and status, like offset of local time from UTC and the flag indicating if daylight saving time is in effect.
- c) LTMS time master supervision logical node that is used for supervision of the time synchronization function; it indicates the current time source and time synchronization status according to IEC 61850-9-2.
- d) Multicast sampled values publisher that is responsible for publishing of the synchrophasor data stream over Ethernet at configured reporting rates.

Figure 2-1 shows representation of synchrophasor measurements via the MMXU logical node objects and attributes.

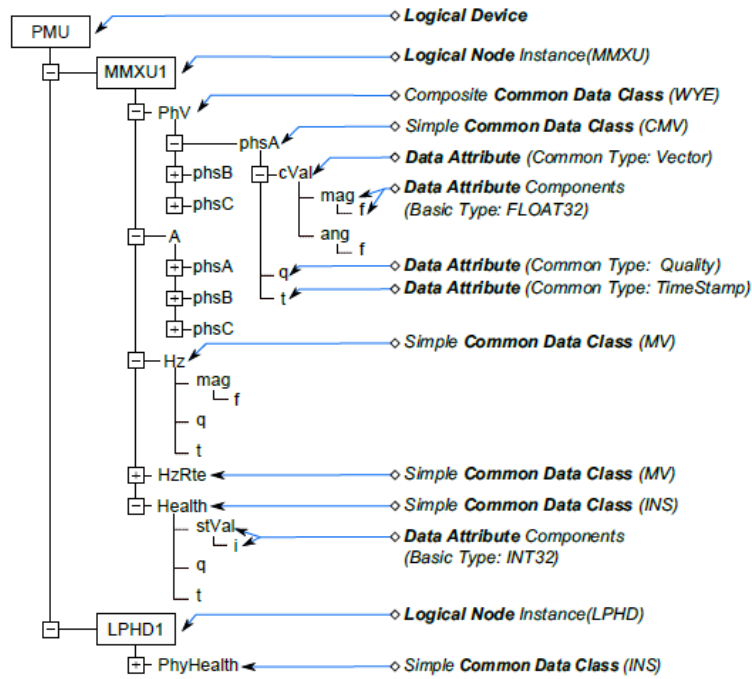

Figure 2-1 MMXU logical node data model

Encoding Phasor Data in Multicast SV APDU

IEEE C37.118.2 synchrophasor data stream is mapped to IEC 61850-9-2 sampled values APDU (application protocol data units). The sampled values dataset is user configurable.

Encoding of the sampled values APDU frame is shown in Figure 2-2.

The APDU contains a single ASDU (application service data unit), which is encoded using ISO/IEC 8825-1 ASN.1 basic encoding rules (BER) with context-specific field tag octets listed in IEC 61850-9-2, Table 14.

Unlike other PDU attributes, a sequence of sampled phasor data is encoded as a compact block without ASN.1 tag triplets. The dataset members are encoded in their basic forms using fixed-length basic data type encoding rules listed in IEC 61850-9-2 Table 15. An example of PMU dataset encoding is shown at right in Figure 2-2.

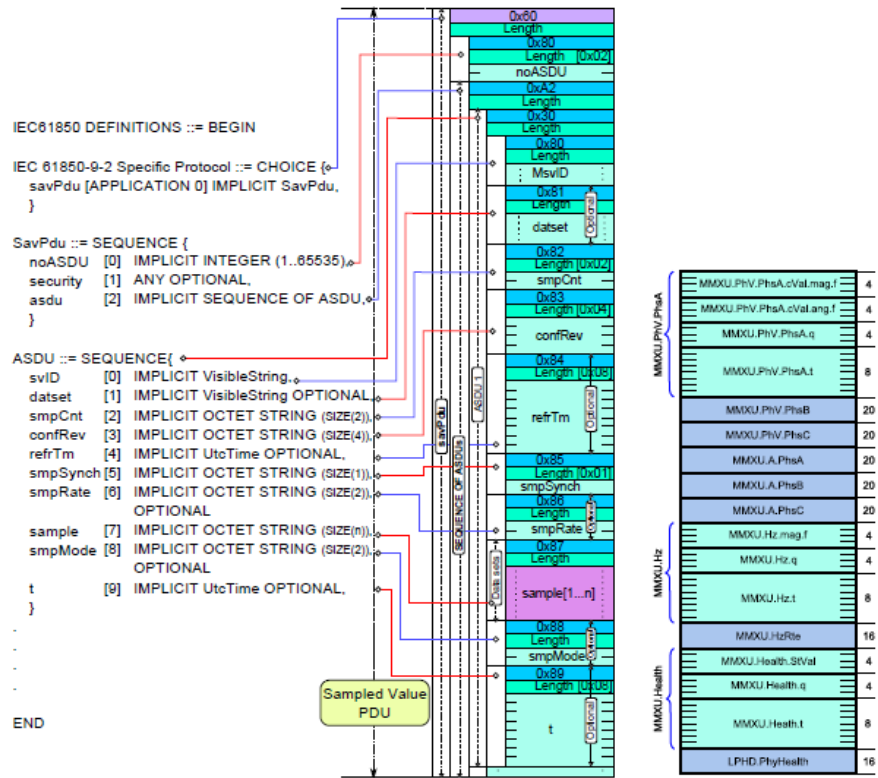

Figure 2-2 Encoding of the SV APDU frame and synchrophasor data (at right)

The following picture shows a captured multicast sampled values frame transmitting a synchrophasor data stream over a local Ethernet network.

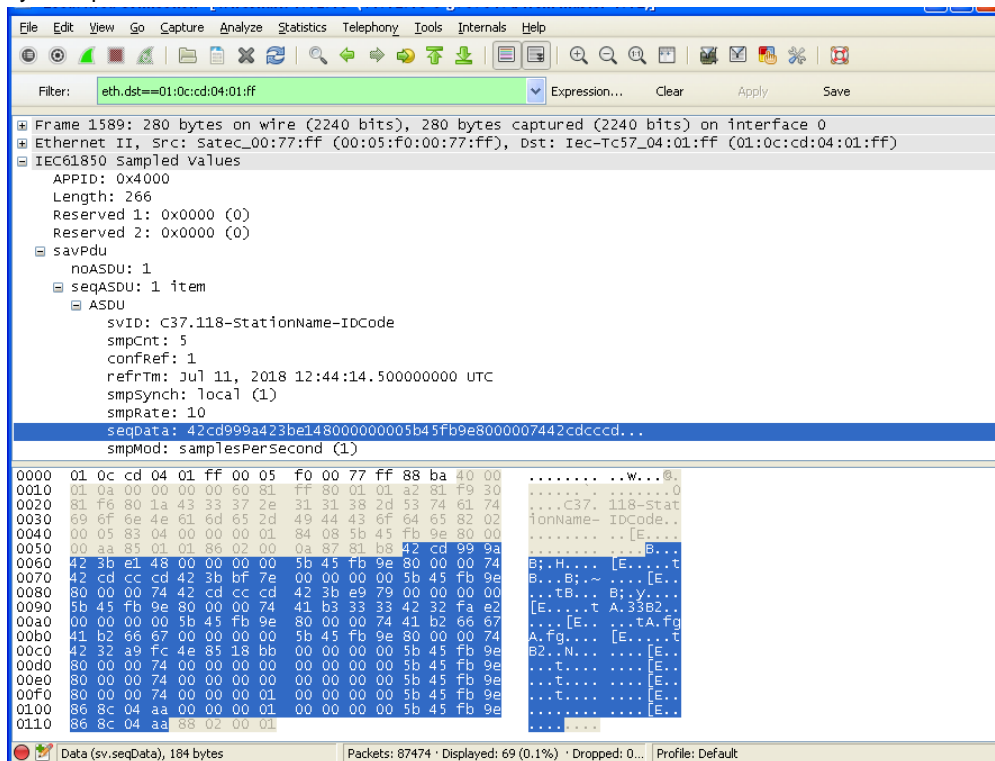

Figure 2-3 Captured synchrophasor multicast sampled values frame

Time Synchronization

Time synchronization can provide a common time basis for the fault recorders in a protection or control system so that events and disturbances within the entire station can be compared to one another.

The PM180 can receive time synchronization signal either from a GPS satellite clock that has an IRIG-B time code output or from another device that can provide minute-aligned time synchronization pulses through relay contacts connected to DI1-DI48 PM180 digital input, or from the Ethernet network using SNTP protocol.

The PM180¹ IRIG-B Module port uses un-modulated (pulse-width coded) time code signal (unbalanced 5V level), according to IRIG Standard 200-04, supporting IRIG-B000/B001 and – B004/B005 code, the IRIG time code designation consists of a letter and three digits, the bold codes are those which are supported, as shown below:

IRIG Time code Formats table

Format	Pulse Rate (or bit rate)	Index Count interval
IRIG-A	1000 PPS (pulses per second)	1 ms
IRIG-B	100 PPS	10ms
IRIG-D	1 PPM (pulses per minute)	1 minute
IRIG-E	10 PPS	100ms
IRIG-G	10000 PPS	0.1ms
IRIG-H	1 PPS	1 second

IRIG Signal Identification Numbers (3 digits)

1 st Digit	Modulation
0	Unmodulated, DC Level Shift (DCLS), pulse-width coded
1	Amplitude modulated, sine wave carrier
2	Manchester modulated
2 nd Digit	Carrier Frequency/Resolution
0	No carrier (DCLS)
1	100 Hz/10ms resolution
2	1 kHz/1ms resolution
3	10 kHz/100µs resolution
4	100 kHz/10µs resolution

3 rd Digit	Modulation
0	BCD_{TOY}, CF, SBS
1	BCD_{TOY}, CF
2	BCD _{TOY} ,
3	BCD _{TOY} , SBS
4	BCD_{TOY}, BCD_{YEAR}, CF, SBS
5	BCD_{TOY}, BCD_{YEAR}, CF
6	BCD _{TOY} , BCD _{YEAR}
7	BCD _{TOY} , BCD _{YEAR} , SBS

¹ In PM180 N3 Version, the IRIG-B synchronization port is also available from the CPU board.

For more information on time synchronization in your device and IRIG-B operation, see [Time Synchronization Source](#) in section Local Settings, Chapter 6.

Device Diagnostics

Device diagnostic messages may appear as a result of the PM180 built-in diagnostic tests performed during start-up and device operation.

All diagnostic events are recorded in the device Event log and can be inspected via PAS (see [Viewing the Event Log](#) in Chapter 13). The diagnostics status is also stored in a non-volatile register, which is not affected by loss of power and may be read and cleared via PAS, from the RDM, or from a user application. Refer to the PM180 communication guides for the diagnostic register address and layout. See [Device Diagnostic Codes](#) in Appendix F for the list of diagnostic codes and their meanings.

Device failures are divided into three categories:

1. Non-critical intermittent faults with auto-reset. They do not cause the device to restart but may cause temporary degradation of device functionality, like IRIG-B time code signal faults. These faults are cleared automatically as the condition that caused the fault disappears.
2. Non-critical recoverable hardware or configuration faults with manual reset. These faults normally cause the device to restart followed by repairing of the configuration data. These faults must be cleared manually via PAS, from the RDM, or from a user application.
3. A critical unrecoverable hardware or configuration failure. The reason may be an unrecoverable sampling failure, or corruption of the time, the factory device configuration or the calibration setup data. A critical error causes the device to release all its outputs and to stop normal operation until the faults that caused the critical error are cleared.

Hardware failures are normally non-critical recoverable faults that do not cause a system failure but may cause data loss. Hardware failures are often caused by excessive electrical noise in the region of the device.

A configuration reset may also be a result of the legal changes in the device configuration whenever other configuration data is affected by the changes made.

In the event of a device fault, check the fault reason and clear the device diagnostics. If the reason is a time fault, update the device clock. In the event of a configuration reset, determine the device setup affected by the fault via the event log, and then verify the setup data.

See [Viewing and Clearing Device Diagnostics](#) in Chapter 10, [Viewing and Clearing Device Diagnostics](#) in Chapter 3, and [Status Information Display](#) in Chapter 3 on how to inspect and clear the device diagnostics status.

If the device continuously resets itself or an unrecoverable critical error occurs, contact your local distributor.

Device Fault Alarm

The PM180 provides a global "DEVICE FAULT" event flag that is asserted all the time while one of the non-critical diagnostics events exists. It can be checked from a setpoint (see Using Control Setpoints in Chapter 6) to give a fault indication via a relay output. If the alarm relay is programmed for failsafe mode using inverting polarity, then its normally closed contacts will be open if either the device loses power or a non-critical device fault occurs. Note that in the event of a critical system failure, all relay outputs are automatically released.

NOTE

The IRIG-B time faults may not be masked and may not be cleared externally. If the IRIG-B time code signal is not provided, set the device time synchronization input to any unused digital input (see [Local Settings](#) in Chapter 6) to avoid fault alarms caused by the IRIG-B port.

Chapter 3 Using the RDM

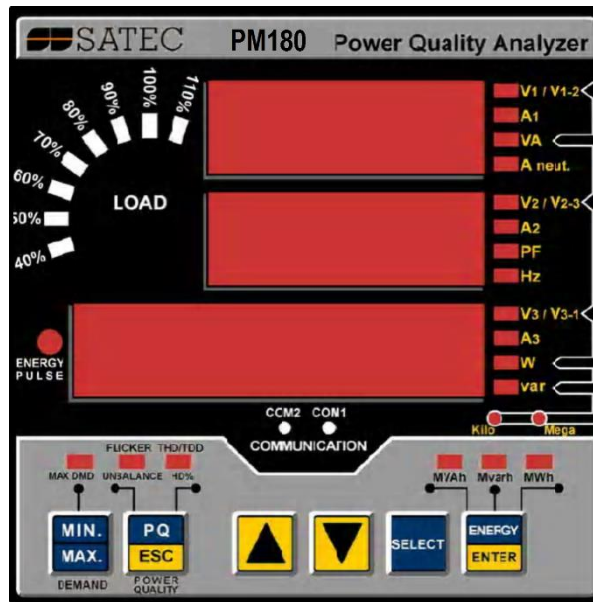

Connecting the RDM

Connect the RDM to the PM180 COM3 port using the supplied cable as shown in the PM180 Installation Manual. When the PM180 is powered, the RDM display lights up.

The COM3 and RDM communications settings must match one another. Both the COM3 port and the RDM RS-485 port are factory preset to 19200 bps, 8-bits/no-parity, device address 1, Modbus RTU protocol.

When the RDM fails to establish communications with the PM180, the RDM display indicates a connection error as shown on the left picture. When this happens:

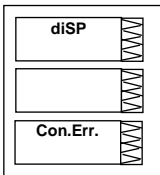

1. Check your connections
2. Check whether the PM180 is in the Service Mode
3. Check whether communications settings in the RDM match the settings made for the COM3 port of the PM180. For information on how to get the serial port settings in your PM180, see [Configuring Serial Ports](#) in Chapter 3 "Using HyperTerminal". If you want to revise the RDM communications settings, press ENTER and follow guidelines for the Display Setup menu (see [Configuring the RDM](#))

Data Display

The RDM has a simple interface that allows you to display numerous measurement parameters in different display pages. The numeric LED display shows up to three parameters at a time. Small round LEDs on the right and below the display indicate displayed parameters and their measurement units.

The display is updated approximately once per second; you can adjust the update rate via the Display Setup Menu (see [Configuring the RDM](#)).

Measurement Units

Depending on the connection scheme of the PM180, the RDM can be ordered for direct wiring or wiring via PTs. Measurement units for voltage and power depend on the connection scheme of the device:

- When direct wiring is used, voltages are displayed in volts with one decimal place, and power in kilowatts with three decimal places.
- When wiring via PT is used, the PT ratio up to and including 4.0, voltages are displayed in volts, and power in whole kilowatts.
- For the PT ratio above 4.0, voltages are displayed in kilovolts, and power in megawatts with three decimal places.

Currents are displayed in amperes with two decimal places.

Primary and Secondary Volts

Volts are displayed in primary (default) or secondary units. Change the volts display mode through the Display Setup Menu (see [Configuring the RDM](#)).

Auto Scroll

With Auto Scroll option enabled (see [Configuring the RDM](#)), the common measurements display (main screen) scrolls automatically after 30 seconds of uninterrupted use.

To stop auto scrolling, press either arrow key.

Auto Return to the Main Screen

With Auto Return option enabled (see [Configuring the RDM](#)), the display automatically returns to the main screen from any other measurement screen after 30 seconds of uninterrupted use.

Simple Reset of Accumulated Data

When changing data via the communications is not password protected, you can reset the Min/Max registers, maximum demands and energies from the display mode without entering the reset menu.

Diagnostics Display

If a critical error occurs in the PM180, the RDM stops updating the display and shows a diagnostic message "Critic Error". The diagnostic page in the Status Information display (see [Status Information Display](#) below) indicates a critical error until the error is cleared. See [Device Diagnostic Codes](#) in Appendix F for the list of diagnostic events that cause a critical error.

Clear the device diagnostics error via the RDM from the Status Information display (see [Resetting Device Diagnostics](#)), or examine what event caused the critical error and clear the device diagnostics through HyperTerminal (see [Using HyperTerminal](#)) or through PAS (see [Viewing and Clearing Device Diagnostics](#) in Chapter 10).

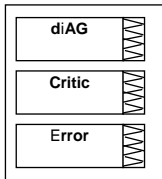

Navigation Keys

The RDM navigation keys are used as follows:



MIN/MAX

MIN/MAX - Selects the Min/Max and Max. Demand Display



PQ

PQ - Selects the Power Quality - FLICKER or Total Harmonics Display



ENERGY

ENERGY - Selects the Energy Display

DOWN ARROW

DOWN ARROW - Scrolls forwards through the pages

UP ARROW

UP ARROW - Scrolls backwards through the pages

Pressing both the UP and DOWN arrow keys together returns to the first page within the current display.

The common measurements display (main screen) does not have an indicator LED. If no LED is lit up below the display, this means that the common measurement parameters are being displayed at

this time. To return to the common measurements from another display, just press the same key (the key pointed to by an illuminated LED) until the illuminated LED goes out.

Common Measurements Display

The RDM is displaying the common measurements parameters if none of the display LEDs are illuminated. Press the key indicated by the illuminated LED to return to the common measurements parameters.

The following table shows common measurements pages displayed. The bold font highlights the abbreviated labels that appear in the windows to designate some parameters in addition to the LEDs that show measurement units. Note that phase-to-neutral volts page (with the "P" label) is displayed only in wiring connections with a neutral.

Page	Label	Parameter	Units LED
1		V12	V1/V1-2 - kV1/kV1-2
		V23	V2/V2-3 - kV2/kV2-3
	L	V31	V3/V3-1 - kV3/kV3-1
2		V1	V1/V1-2 - kV1/kV1-2
		V2	V2/V2-3 - kV2/kV2-3
	P	V3	V3/V3-1 - kV3/kV3-1
3		I1	A1
		I2	A2
		I3	A3
4		Total kVA	kVA/MVA
		Total power factor	PF
		Total kW	kW/MW
5		Neutral current	A Neut.
		Frequency	Hz
		Total kvar	kvar/Mvar
6		C4	
		I4	
7		U. dC.	
		DC voltage	
8		U. Unb.	
		Voltage unbalance	
9		C. Unb.	
		Current unbalance	
10		Ph.L1	
		Power factor L1	PF
		kW L1	kW/MW
11		kVA L1	kVA/MVA
		Ph.L1	
		kvar L1	kvar/Mvar
12		Ph.L2	
		Power factor L2	PF
		kW L2	kW/MW
13		kVA L2	kVA/MVA
		Ph.L2	
		kvar L2	kvar/Mvar
14		Ph.L3	
		Power factor L3	PF
		kW L3	kW/MW
15		kVA L3	kVA/MVA
		Ph.L3	
		kvar L3	kvar/Mvar
16		Fundamental V1/V12	V1/V1-2 - kV1/kV1-2
		Fundamental V2/V23	V2/V2-3 - kV2/kV2-3
	1H	Fundamental V3/V31	V3/V3-1 - kV3/kV3-1
17		Fundamental I1	A1
		Fundamental I2	A2
	1H	Fundamental I3	A3
18		01H	
		Fundamental total power factor	PF
		Fundamental total kW	kW/MW

Phase Powers Readings

In addition to three-phase power, the RDM shows per-phase power readings in configurations with a neutral. By default, they are disabled. See [Configuring the RDM](#) on how to enable per-phase power readings in your RDM.

Fundamental Harmonic Readings

The RDM shows volts, currents, total power factor and active power for the fundamental harmonic if they are enabled through the Display Setup Menu (see [Configuring the RDM](#)).

Min/Max and Max. Demand Display

Press the MIN/MAX key. The MIN/MAX LED is illuminated. Use the UP/DOWN arrow keys to scroll through Min/Max and Max. Demand measurements.

The following table shows Min/Max display pages. Note that volts readings are phase-to-neutral in 4LN3 and 3LN3 wiring modes, and phase-to-phase in all other modes.

Page	Label	Parameter	Units LED
1		Minimum V1/V12	V1/V1-2 - kV1/kV1-2
		Minimum V2/V23	V2/V2-3 - kV2/kV2-3
	Lo	Minimum V3/V31	V3/V3-1 - kV3/kV3-1
2		Minimum current I1	A1
		Minimum current I2	A2
	Lo	Minimum current I3	A3
3		Minimum total kVA	kVA/MVA
		Minimum total power factor	PF
	Lo	Minimum total kW	kW/MW
4		Minimum neutral current	A Neut.
		Minimum frequency	Hz
	Lo	Minimum total kvar	kvar/Mvar
5		Maximum voltage V1/V12	V1/V1-2 - kV1/kV1-2
		Maximum voltage V2/V23	V2/V2-3 - kV2/kV2-3
	Hi	Maximum voltage V3/V31	V3/V3-1 - kV3/kV3-1
6		Maximum current I1	A1
		Maximum current I2	A2
	Hi	Maximum current I3	A3
7		Maximum total kVA	kVA/MVA
		Maximum total power factor	PF
	Hi	Maximum total kW	kW/MW
8		Maximum neutral current	A Neut.
		Maximum frequency	Hz
	Hi	Maximum total kvar	kvar/Mvar
9		Maximum volt demand V1/V12	V1/V1-2 - kV1/kV1-2
		Maximum volt demand V2/V23	V2/V2-3 - kV2/kV2-3
	Hd	Maximum volt demand V3/V31	V3/V3-1 - kV3/kV3-1
10		Maximum ampere demand I1	A1
		Maximum ampere demand I2	A2
	Hd	Maximum ampere demand I3	A3
11		Maximum sliding window kVA demand	kVA/MVA
		Power factor (import) at maximum kVA demand	PF
	Hd	Maximum sliding window kW import demand	kW/MW

Power Quality Display

Press the THD/TDD key. The THD or TDD LED illuminates. Use the UP/DOWN arrow keys to scroll through harmonics measurements.

The following table lists the available display pages. Note that voltage harmonics readings are phase-to-neutral in 4LN3 and 3LN3 wiring modes, and phase-to-phase in all other modes.

Page	Label	Parameter	Units LED
1		THD V1/V12	V1/V1-2 - kV1/kV1-2
		THD V2/V23	V2/V2-3 - kV2/kV2-3
	thd.	THD V3/V31	V3/V3-1 - kV3/kV3-1
2		THD I1	A1
		THD I2	A2
	thd.	THD I3	A3
3		TDD I1	A1
		TDD I2	A2

Page	Label	Parameter	Units LED
4		TDD I3	A3
		K-Factor I1	A1
	HF	K-Factor I3	A2
5 ¹		Pst V1/V12	V1/V1-2 - kV1/kV1-2
		Pst V2/V23	V2/V2-3 - kV2/kV2-3
	PSt	Pst V3/V31	V3/V3-1 - kV3/kV3-1
6 ¹		Plt V1/V12	V1/V1-2 - kV1/kV1-2
		Plt V2/V23	V2/V2-3 - kV2/kV2-3
	PLt	Plt V3/V31	V3/V3-1 - kV3/kV3-1

Energy Display

Press the ENERGY key. The MVAh, Mvarh, or MWh LED illuminates. Use the UP/DOWN arrow keys to scroll through energy measurements.

The following table shows energy display pages.

Page	Label	Parameter	Units LED
1		Ac.En.	
		IP.	
		MWh import	MWh
2		rE.En.	
		IP.	
		Mvarh import	Mvarh
3		AP.En.	
		MVAh	MVAh
4		Ac.En.	
		EP.	
		MWh export	MWh
5		rE.En.	
		EP.	
		Mvarh export	Mvarh
6		U-h	
		Volt-hours	
7		A-h	
		Ampere-hours	

Status Information Display

The RDM has separate status information pages accessible through the MAIN RDM menu. For information on navigating in the RDM menus, see "Using the Menus".

To enter the Status Information Display:

1. From the Data display, press SELECT to enter the Main Menu. The "STA" window flashes.
2. Press ENTER to enter the Status Information Display. Use the UP/DOWN arrow keys to scroll through the status pages.

To exit the Status Information Display:

1. Press ESC to return to the Main Menu.
2. Press ESC to return to the Data display.

The Status Information Display allows you to view Device Diagnostics, status of digital inputs and relays, counters and a phase rotation order. It is especially useful when you connect the PM180 inputs and outputs to external equipment.

The table below lists the status information pages.

Page	Parameter	Description
1	diAG	When a critical error occurs, the "Crit. Error" message is displayed (see Diagnostics Mode)
	Critic	
	Error/nonE	
2	rEL.	
	1.2.3.4.5.6	

Page	Parameter	Description
3	Relay #1-6 status	0 = relay is open, 1 = relay is closed
	St.In 1.2.3.4.5.6	
	Digital (status) Inputs #1-#6	0 = open, 1 = closed
4	St.In 7.8.9.A.b.C	
	Digital (status) Inputs #7-#12	0 = open, 1 = closed
5	Cnt.1	
	Counter #1	
6	Cnt.2	
	Counter #2	
	...	
20	Cnt.16	
	Counter #16	
21	PHAS. rOt.	
	Phase rotation order (POS/NEG/ERR)	

Resetting Counters

When changing data is not password protected, you can reset the counters from the Status Information Menu display without entering the reset menu:

1. Select a display page where the counter you want to reset is displayed.
2. While holding the SELECT key, press and hold the ENTER key for about 5 seconds until the displayed data is reset to zero.

Resetting Device Diagnostics

When the Device Diagnostics page shows a critical error, you can clear it from this page:

1. Select the Device Diagnostics page.
2. While holding the SELECT key, press and hold the ENTER key for about 5 seconds until the displayed data is reset to NONE.

Using the Menus

The RDM menus allow you to configure your RDM display and set up primary parameters in the PM180, such as time, basic device configuration, serial ports settings, security settings (passwords and protection status). Through the RDM menus, you can also easily reset main accumulated values, such as device counters, energy registers, maximum demands, Min/Max log, and device diagnostics.

Navigation Keys

In the RDM menus, the navigation keys are used as follows:



SELECT

SELECT - Selects an active window (selected window is flashing)



ENTER

ENTER - Enters menu/sub-menu or confirms changes made in the active window



ESC

ESC - Returns to a higher menu or aborts changes made in the active window

UP ARROW

UP ARROW - Scrolls options forwards or increments a number in the active window

DOWN ARROW

DOWN ARROW - Scrolls options backwards or decrements a number in the active window

Selecting Menus

To access the RDM menus, press the SELECT key. The MAIN menu is open as shown at left. The MAIN menu entries are as follows:

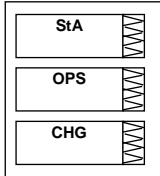

- StA - Status Information Display (see [Status Information Display](#) above)
- OPS - Setup Options Menu (allows reviewing setups without changing)
- CHG - Setup Change Menu (allows changing setups)

To enter the Status Information Display:

1. If the StA window is not a current active window, use the SELECT key to activate it.
2. Press the SELECT key to enter the Status Information Display

For viewing the RDM or the PM180 setup options:

1. Press the SELECT key to activate the OPS window.
2. Press the SELECT key to enter the Setup Options Menu.

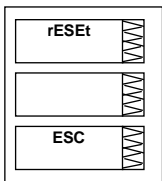

To change the RDM or the PM180 setup, or to clear the accumulated values:

1. Press the SELECT key to activate the CHG window.
2. Press the SELECT key to enter the Setup Options Menu.

Entry to this menu can be password protected.

After entering either OPS or CHG menu, the list of setup menus is displayed in the upper window as shown at left. Use the Up/Down keys to scroll through the menus. Press ENTER to enter the selected menu.

Entering a Password

The setup menus can be secured by a user-defined 8 digits password. The device is shipped with password protection disabled. To enable password protection or to change a password, see [Access Control Menu](#).

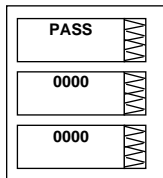

If authorization is required, the Password menu appears as shown left.

To change the RDM or the PM180 setup, or to clear the accumulated values:

1. Set the first digit using the Up/Down arrow keys.
2. Press SELECT to advance to the next digit.
3. Set the other password digits in the same manner.
4. Press ENTER to confirm the password.

If the password entered is incorrect, you are returned to the previous menu.

Entering Numbers

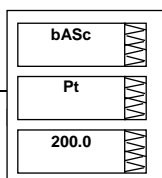

To change a number in the active (flashing) window, use the Up/Down arrow keys. If you press and release the arrow key, the value is incremented or decremented by

one. If you press and hold the key, the value in the window is updated approximately twice per second. If you hold the key for more than 5 seconds, the position of the digit being changed moves to the adjacent higher digit.

To accept the new value, press ENTER.

To abort changes, press ESC.

Configuring the RDM

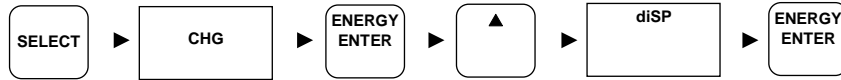
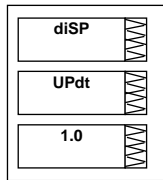

To change communication or display options for your RDM, select “diSP” from the menu list.

The following table lists available display options, their default settings and ranges.

Label	Option	Range	Default	Description
Updt	Update rate	0.1-10.0 sec	1 sec	Defines the interval between display updates
ScrL	Auto scroll	NONE, 2-15 sec	NONE	Disables auto scroll or defines the scroll interval for the main data display
rEtn	Auto return to the main screen	diS, En	diS	Disables or enables auto return to the main display after 30 seconds of uninterrupted use
Uolt	Primary/Secondary volts units	Pri, SEc	Pri	Sets primary or secondary units for volts display
Ph.P	Phase powers display mode	diS, En	diS	Disables or enables phase powers in the main display
Fund.	Fundamental values display mode	diS, En	diS	Disables or enables fundamental values in the main display
dAtE	Date order	dnY, ndY, Ynd,	ndY	Defines the date order in the RTC display
Addr	Master PM180 device address	1-247	1	The target PM180 device address (must match the PM180 COM3 port setting)
bAud	Baud rate	4800-115200	19200	The RDM port baud rate (must match the PM180 COM3 port setting)
dAtA	Data format	8n	8n	The RDM port data format (must match the PM180 COM3 port setting)

To select a display option:

1. Press SELECT to activate the middle window.
2. Use the Up/Down arrow keys to scroll to the desired option.

To change the display option:

1. Press SELECT to activate the lower window.
2. Use the Up/Down arrow keys to set the desired option.
3. Press ENTER to confirm your changes and to store your new setting, or press ESC to discard changes.

To exit the display menu:

From the middle window, press ESC or ENTER.

Configuring the PM180

The RDM allows you to set up only limited number of parameters in your PM180, such as basic configuration settings and communications settings for serial ports. All other settings can be made through HyperTerminal and PAS.

Clock Setup Menu

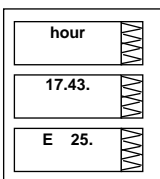

This menu allows you to set up the device clock and to configure your local time zone settings.

The following table lists available options.

Label	Option	Format/Range	Default	Description
hour	Time	hh.mm.ss		The time is displayed as hh.mm.ss, where the hours and minutes are shown in the middle window separated by a dot, and the seconds - in the lower window.
		E		The letter "E" at left shows that the time is locked, i.e., is synchronized to the GPS satellite time
		U		The letter "U" at left shows that the time is unlocked, i.e., the satellite signal was lost and the GPS receiver runs in freewheeling mode
date	Date	YY.MM.DD, MM.DD.YY, DD.MM.YY		The date is displayed as per the user definition, where the first two items are shown in the middle window, and the last one - in the lower window. For instructions on how to select the date format, see Configuring the RDM .
dAY	Day of week	Sun = Sunday Mon = Monday TuE = Tuesday WEd = Wednesday thu = Thursday Fri = Friday Sat = Saturday		The day of the week is displayed in the lower window. It is set automatically when you change the date.
dSt	Daylight savings time option	diS = disabled En = enabled	En	When DST is disabled, the RTC operates in standard time only. When enabled, the device automatically updates the time at 2:00 AM at the pre-defined DST switch dates.
dSt.S	DST start date	Month-week-weekday Week = 1 st , 2 nd , 3 rd , 4 th or LSt (last week of the month)		The DST start date when Daylight Savings Time begins. The DST switch point is specified by the month, week of the month and weekday. By default, DST starts at 2:00 AM on the first Sunday in April of each year.
dSt.E	DST end date	Month-week-weekday Week = 1 st , 2 nd , 3 rd , 4 th or LSt (last week of the month)		The DST end date when Daylight Savings Time ends. The DST switch point is specified by the month, week of the month and weekday. By default, DST ends at 2:00 AM on the last Sunday in October of each year.
OFFSET	Local time zone offset, min	-720 to 720 min	-300 (Eastern Time)	Local offset in minutes from UTC (Universal Coordinated or Greenwich Mean Time)

To select a setup option, use the Up/Down arrow keys from the upper window.

To change the time, date, DST setting or local time offset:

1. Press SELECT to activate the desired item. When you enter the time setup display, the hours and minutes indications are frozen to allow you to adjust them.
2. Use the Up/Down arrow keys to set the desired value.
3. Set the other option items in the same manner.
4. Press ENTER to confirm your new settings, or press ESC to discard changes. If you confirm the time change and the seconds window is not currently active, the seconds stay unchanged.

To reset seconds:

1. Press SELECT to activate the seconds window.
2. Press ENTER.

To exit the menu:

From the upper window, press ESC or ENTER.

Basic Setup Menu

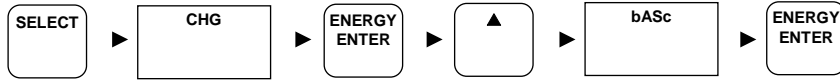
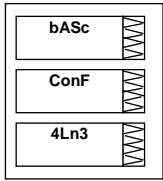

This menu allows you to configure the basic device settings of the PM180 that define the general operating characteristics of the device. To enter the Basic Setup menu, select "bASc" from the menu list.

The following table lists available options, their default settings and ranges.

Label	Option	Range	Default	Description
ConF	Wiring connection mode (configuration)	See Table below	4Ln3	The wiring connection of the device
Pt ¹	V1-V3 PT ratio	1.0 - 6500.0	1.0	The phase potential transformer ratio (primary to secondary ratio)
Pt.SEc	V1-V3 PT secondary	10 - 690 V	120	The phase potential transformer's secondary phase-to-phase voltage
Pt.4 ¹	V4 PT ratio	1.0 - 6500.0	1.0	The V4 potential transformer ratio (primary to secondary ratio)
Pt.4SEc	V4 PT secondary	10 - 690 V	120	The V4 potential transformer's secondary voltage
Ct ²	I1-I3 CT primary current	1 - 10000 A	5	The primary rating of the phase current transformer on standard (20A/10A) inputs
Ct.4 ²	I4 CT primary current	1-10000 A	5	The primary rating of the I4 current transformer on standard (20A/10A) inputs
Ct.E. ²	I1x-I3x CT primary current	1 - 10000 A	5	The primary rating of the phase current transformer on extended (100A) inputs
Ct.4.E. ²	I4x CT primary current	1 - 10000 A	5	The primary rating of the I4x current transformer on extended (100A) inputs
U.dC.	VDC nominal voltage	10-300 V	125	The nominal VDC voltage
FrEq	Nominal frequency	50, 60 Hz	50 (60 for North America)	The nominal power frequency
PH.Ord.	Phase order	AbC, ACb	AbC	The normal phase sequence
Ld C	I1-I3 Maximum demand load current	0 - 10000 A	0	The maximum demand load current for I1-I3 current inputs (0 = CT primary)
Ld C4	I4 Maximum demand load current	0 - 10000 A	0	The maximum demand load current for the I4 current input (0 = CT primary)
Ld C.E.	I1x-I3x Maximum demand load current	0 - 10000 A	0	The maximum demand load current for I1x-I3x current inputs (0 = CT primary)
Ld C4.E.	I4x Maximum demand load current	0 - 10000 A	0	The maximum demand load current for the I4x current input (0 = CT primary)

¹ PT Ratio is defined as a relation of the potential transformer's primary voltage rating to its secondary rating. For example, if your potential transformer's primary rating is 14400V and the secondary rating is 120V, then the PT Ratio = 14400/120 = 120.

Available wiring modes are listed in the following table.

Wiring Mode	Description
3OP2	3-wire Open Delta using 2 CTs (2 element)
4Ln3	4-wire Wye using 3 PTs (3 element), line-to-neutral voltage readings
3dir2	3-wire Direct Connection using 2 CTs (2 element)
4LL3	4-wire Wye using 3 PTs (3 element), line-to-line voltage readings
3OP3	3-wire Open Delta using 3 CTs (2½ element)
3Ln3	4-wire Wye using 2 PTs (2½ element), line-to-neutral voltage readings
3LL3	4-wire Wye using 2 PTs (2½ element), line-to-line voltage readings
3bLn3	3-wire Broken Delta using 2 PTs, 3 CTs (2½-element), line-to-neutral voltage readings
3bLL3	3-wire Broken Delta using 2 PTs, 3 CTs (2½-element), line-to-line voltage readings

To select a setup option:

1. Press SELECT to activate the middle window.
2. Use the Up/Down arrow keys to scroll to the desired option.

To change the display option:

1. Press SELECT to activate the lower window.

2. Use the Up/Down arrow keys to set the desired option.
3. Press ENTER to confirm your changes and to store your new setting, or press ESC to discard changes.

To exit the menu:

From the middle window, press ESC or ENTER.

⊗ Notes

1. Always specify the wiring mode and transformer ratings prior to setting up setpoints and triggers for the fault and power quality recorders.
2. The maximum value for the product of the phase CT primary current and PT ration is 10,000,000. If the product is greater, the powers and power factors are zeroed.

Demand Setup Menu

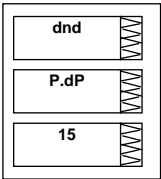

This menu allows you to configure the time parameters for calculating power, ampere, volt and harmonic demands. To enter the Basic Setup menu, select “dnd” from the menu list.

The following table lists available options, their default settings and ranges.

Label	Option	Range	Default	Description
P.dP	Power demand period	1, 2, 5, 10, 15, 20, 30, 60 min	15	The length of the demand period for power demand calculations
n.P.dP	The number of demand periods in the sliding window	1-15	1	The number of demand periods to be averaged for sliding window demands
d.Snc.In	Power demand sync source	Clc (device clock), di.In.1 - di.In.48 (digital input 1-48)	Clc	The source input for synchronization of the demand intervals. If a digital input is specified as the source, a pulse front denotes the start of the demand interval
A.dP	Ampere demand period	0 - 9000 sec	900	The length of the demand period for ampere demand calculations
U.dP	Volt demand period	0 - 9000 sec	900	The length of the demand period for volt demand calculations
H.dP	Harmonic demand period	0 - 9000 sec	900	The length of the demand period for harmonic demand calculations

To select an option:

1. Press SELECT to activate the middle window.
2. Use the Up/Down arrow keys to scroll to the desired option.

To change the option:

1. Press SELECT to activate the lower window.
2. Use the Up/Down arrow keys to set the desired option.
3. Press ENTER to confirm your changes and to store your new setting, or press ESC to discard changes.

To exit the menu:

From the middle window, press ESC or ENTER.

Communication Setup Menus

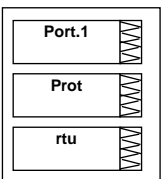

These three menus allow you to configure the main settings for ports COM1-COM3. Additional settings such as delays and timeouts can be configured through HyperTerminal. To enter the desired Port Setup menu for ports COM1-COM3, select “Port.1”, “Port.2” or “Port.3” from the menu list.

The following table lists available port options, their default settings and ranges.

Label	Option	Range	Default
Prot	Communications protocol	rtu - MODBUS RTU ASCII - MODBUS ASCII dnP3 - DNP3.0	rtu
rS	Port interface	232, 422, 485	232 (COM1) 485 (COM2/3)
Addr	Device address	1-247 (MODBUS) 1-255 (DNP3.0)	1
bAud	Baud rate	300-115200 bps	19200
dAtA	Data format	7E, 8n, 8E	8n

To select a port option:

1. Press SELECT to activate the middle window.
2. Use the Up/Down arrow keys to scroll to the desired option.

To change the port option:

1. Press SELECT to activate the lower window.
2. Use the Up/Down arrow keys to set the desired option.
3. Press ENTER to confirm your changes and to store your new setting, or press ESC to discard changes.

To exit the menu:

From the middle window, press ESC or ENTER.

Device Options Menu

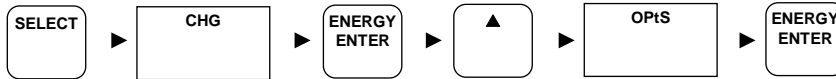
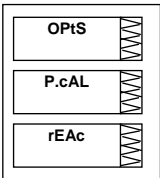

This menu allows you to select some user-configurable device options or put the device into energy test mode. To enter the menu, select "OPtS" from the menu list.

The following table lists available device options, their default settings and ranges.

Label	Option	Range	Default	Description
P.cAL	Power calculation mode	rEAc (using reactive power), nAct (using non-active power)	rEAc	The method used for calculating reactive and apparent powers (see "Power Calculation Modes" in Advanced Device Setup , Chapter 6)
roLL	Energy roll value	10.E4 = 10,000 kWh 10.E5 = 100,000 kWh 10.E6 = 1,000,000 kWh 10.E7 = 10,000,000 kWh 10.E8 = 100,000,000 kWh 10.E9 = 1,000,000,000 kWh	10.E9	The value at which energy counters roll over to zero
test	Energy test mode	OFF, On	OFF	Setting this option to On puts the device into the energy test mode

To select a menu option:

1. Press SELECT to activate the middle window.
2. Use the Up/Down arrow keys to scroll to the desired option.

To change the option:

1. Press SELECT to activate the lower window.
2. Use the Up/Down arrow keys to set the desired option.
3. Press ENTER to confirm your changes and to store your new setting, or press ESC to discard changes.

To exit the menu:

From the middle window, press ESC or ENTER.

Access Control Menu

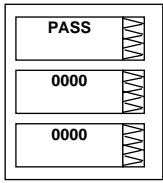

This menu allows you to change the user password and enable or disable the device security. To enter the menu, select "AccS" from the menu list.

To select a menu option, use the Up/Down arrow keys to scroll to the desired option.

To change the password:

1. Select "PASS" in the upper window using the Up/Down arrow keys.
2. Press SELECT to activate the first digit.
3. Set the first digit using the Up/Down arrow keys.
4. Press SELECT to advance to the next digit.
5. Set the other password digits in the same manner.
6. Press ENTER to confirm your changes and to store your new setting, or press ESC to discard changes.

To enable or disable password protection:

1. Select "Ctrl" in the upper window using the Up/Down arrow keys.
2. Press SELECT to activate the lower window.
3. Use the Up/Down arrow keys to set the desired option. Select "On" to enable security, select "OFF" to disable password protection.
4. Press ENTER to confirm your changes and to store your new setting, or press ESC to discard changes.

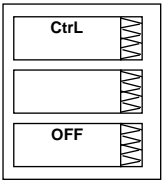

To exit the menu:

From the upper window, press ESC.

Note

The PM180 uses the same password for all communications ports. The password you enter is effective for all ports, as well as in HyperTerminal, Telnet and PAS.

Reset Menu

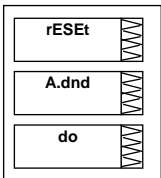

This menu allows you to clear the energy and maximum demand accumulators, Min/Max log, counters and device diagnostics in your PM180. To enter the Reset menu, select rESEt from the menu list.

The following table lists available options.

Label	Description
A.dnd	Clears maximum ampere demands
P.dnd	Clears maximum power demands
dnd	Clears all maximum demands
Enrg	Clears all total energies
Lo.Hi	Clears Min/Max log
tOU.d	Clears summary and TOU maximum demands
tOU.E	Clears summary and TOU energy registers
Cnt	Clears all counters
Cnt1 - Cn16	Clears counter #1 to #16
diAG	Clears device diagnostics

To reset the desired value:

1. Press SELECT to activate the middle window.
2. Use the Up/Down arrow keys to scroll to the desired option.
3. Press SELECT to activate the lower window.

4. Press and hold the ENTER key for about 5 seconds until the “do” label is replaced with “done”, and then release the key.
5. Press ESC to quit the menu.

Chapter 4 Using Telnet

Unlike using HyperTerminal through an RS-232 port, Telnet allows you to access the device through a local network or from any location in the Internet where your device is visible. Just as Windows HyperTerminal, Windows Telnet allows you to configure the network, communications and security settings in your PM180, and to view certain diagnostics information such as device diagnostics and network statistics.

Connecting to the Device

You can establish a telnet connection to the device from Windows HyperTerminal or from Windows Telnet Client.

Running Telnet from HyperTerminal

1. Run HyperTerminal from the Windows Start -> Programs -> Accessories -> Communications menu.
2. Type a name for your new connection and click OK.

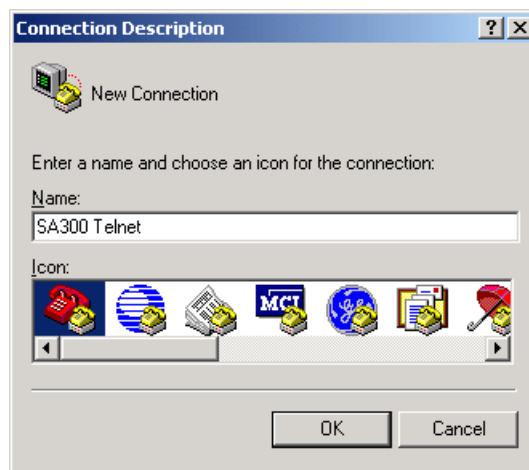

3. In the "Connect Using" box, select TCP/IP (Winsock). In the "Host address" box, type the PM180 IP address. Leave the default Telnet port number 23 unchanged. Click OK.

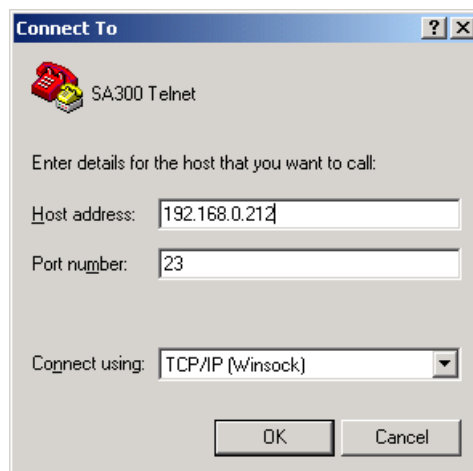

Running the Telnet Client on Windows XP and other

1. From the Start menu, select Run, type `telnet` and click OK.

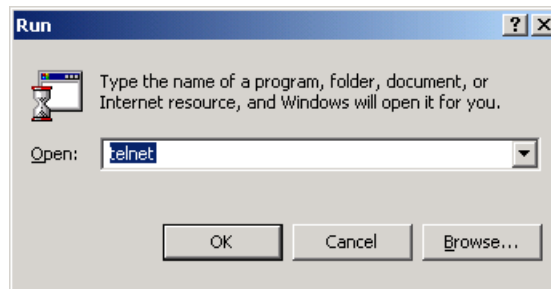

The following text appears in a window:

Microsoft (R) Windows 2000 (TM) Version 5.00 (Build 2195)

Welcome to Microsoft Telnet Client

Telnet Client Build 5.00.99206.1

Escape Character is 'CTRL+]'

Microsoft Telnet>

2. Type `open` followed by the device IP address, for example:

Microsoft Telnet>open 192.168.99.73

```

Telnet 192.168.99.73
Login password: *
PM180 Telnet commands
-----
h or ?      - Display this text
i          - Firmware information
password    - Password setting
time       - Time/Date
com[port]  - Serial port settings
enet       - Ethernet network settings and info
mem        - Storage memory menu
diag       - Print device diagnostics
clrdiag    - Clear device diagnostics
restart    - Reset the device
scales     - Data scaling/limits settings
osinfo     - OS information
>

```

Opening a Telnet Session

When a telnet connection is established, the PM180 Telnet server prints a list of the available commands as follows:

PM180 Telnet commands

```

-----
h or ?      - Display this text
i          - Display firmware information
password    - Password setting

```

time [hh:mm:ss]	- Time
date [dd/mm/yy]	- Date
com[port]	- Serial port settings
net	- Current Network Addresses
ip	- Network settings
log	- Print network log
stat	- Print network statistics
diag	- Print device diagnostics
clrdiag	- Clear device diagnostics
reset	- Reset the device

You are prompted for the password to login, as in the following example:

```
Login password: *  
>
```

If your login was successful, you are not prompted for the password again until you close your telnet session. The default PM180 password is 0 unless you change it through HyperTerminal, Telnet or the RDM. A password is always required for a telnet session regardless of whether the communications security is enabled or disabled.

After receiving the Telnet prompt ">", you can enter your commands.

When you change the Internet IP address in your device or reset the device through telnet, your current connection is lost and you will need to open a new telnet session.

Closing a Telnet Session

To close the Telnet session, close your telnet client application.

Chapter 5 Using PAS

You need the support PAS software to configure most of the PM180 features, such as digital and analog I/O, recorders, energy and TOU registers.

This chapter gives basic information on how to install and run PAS on your computer, and how to program your device using PAS. See Chapter 6 “Programming the PM180” for instructions on how to program particular features in your PM180.

To run PAS, you need at least Windows XP installed on your computer. PAS does not run properly on Windows 95. Under Windows NT, USB communications is not available.

Installing PAS

To install PAS on your computer:

1. Insert the installation CD supplied with your PM180 into CD drive.
2. Open My Computer on your Desktop.
3. Click on your CD drive icon, select the PAS installation directory, and then double click on Setup (shown as an Application type file).
4. Follow InstallShield® Wizard instructions on the screen.



When installation is complete, the PAS icon appears on your Desktop. Double click on the PAS icon to run PAS.

For general information on how to work with PAS, see the “PAS Getting Started” guide supplied on the installation CD.

Installing the USB Driver

To take an advantage of the USB communications, install the PM180 USB driver on your PC. Connect the PM180 to your PC's USB port using the supplied USB cable. When the PM180 is powered up, Windows automatically detects the device as you connect it to a PC and launches the hardware installation wizard.

Windows XP Installation

1. The "Found New Hardware Wizard" dialog box is displayed.



2. Insert the PAS Installation CD into the CD ROM Drive, select “Install the software automatically”, and then click “Next”. Windows XP finds and installs the required driver automatically.

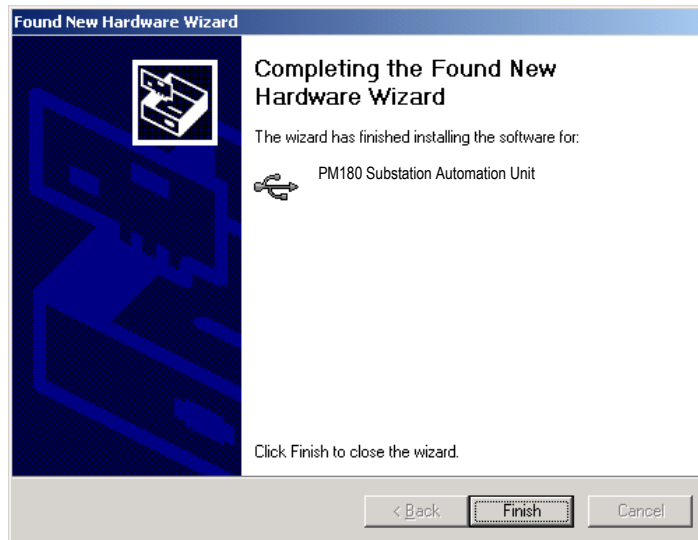

3. Click "Finish" to complete installation.

Creating a New Site for your Device

PAS keeps all communication and configuration data for your device in a database called a site database. When configuring your device, store all setups to the site database so that PAS recognizes device properties regardless of whether the device is online or offline.

When installing PAS on your computer, the "Sites" directory is created in the PAS installation directory. It is advised to keep here all your site databases.

To create a new database for your device:

1. Select Configuration from the Tools menu, and then click Sites at right on the Instrument Setup tab.

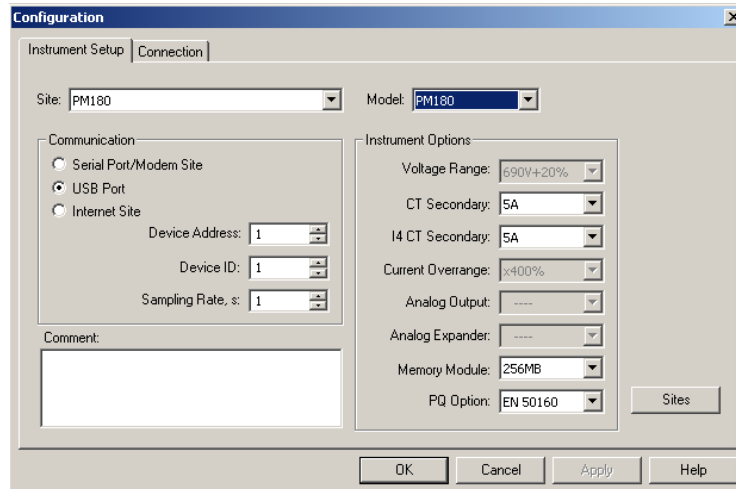

2. From the "Look in" box, select the directory where a new database will be stored. By default, it's the "Sites" directory. Type a site name for your device in the "File name" box, click New, and then click OK.

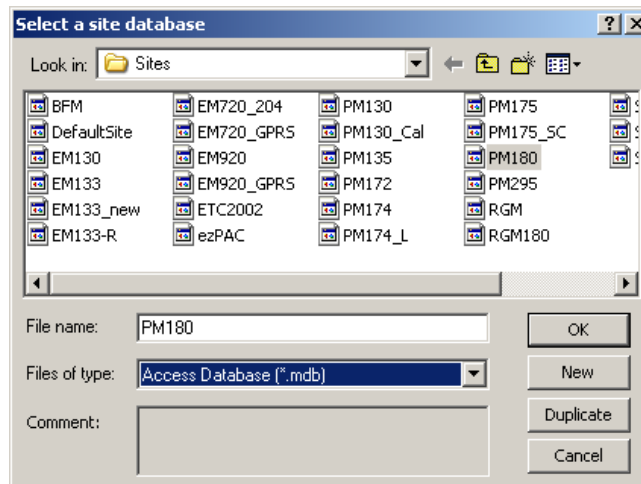

3. On the Instrument Setup tab, select your device model in the “Model” box.
4. In the Instrument Options group boxes, specify the standard current input option for your device, and select the size of the onboard logging memory. Set the current over-range to “×400%” if your device has 20A (ANSI) standard current inputs, or to “×200%” for 10A (IEC) current inputs.
5. You can add any comments into the “Comments” box, such as device location or any other data concerning this particular site.

Setting up Communications

You can communicate with your devices via a PC RS-232 serial port, through the Internet, via either a local Ethernet, or a wireless CELLULAR (GPRS or 3G) Dial-Up connection, and via the USB port through a modem, the Internet, or the USB port.

To configure your communications with the PM180:

1. Select Configuration from the Tools menu. Under the Communication group on the Instrument Setup tab, select the type of a connection for your device.
2. Set the device communication address you assigned to the PM180. When communicating via the Ethernet or a CELLULAR modem, the PM180 responds to any address you select.
3. In the “Sampling Rate” box, select a rate at which PAS updates data on the screen when polling the device via the PAS Data Monitor.

The communication protocol and port settings must match the settings made in your device.

Communicating through a Serial Port

Select Serial Port/Modem Site on the Configuration tab, and then click on the Connection tab to configure your serial port settings.

Selecting the Communications Protocol

1. On the Connection tab, click Protocol.

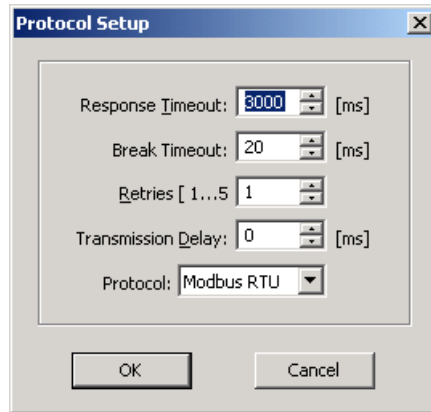

2. In the “Protocol” box, select the same communications protocol as you have in your device.
3. The remaining settings in this dialog do not normally need to be changed.
4. In the “Response Time-out” box, define the maximum time that PAS should wait for the meter response before announcing a failure. When communicating through a CELLULAR modem, this time may require some adjustment.
5. The “Break Time-out” box defines the maximum idle time that PAS waits after receiving the last message character to close a connection. This setting is important only when PAS is running the Modbus RTU or DNP3 or IEC 60870-5 protocols. It does not affect Modbus ASCII communications. The default value of 10 ms is usually sufficient for reliable communications, but the load on your PC can affect it. If there are many applications running on your PC, PAS might be prevented from responding to received characters fast enough, so it may close the communication while the device is still transmitting a message. If you frequently receive the message “Communication failed”, this could mean that “Break Time-out” should be increased. This time is added to the message transfer time, however, increasing it excessively slows down communications.
6. The “Retries” box defines the number of attempts that PAS uses to receive a response from the device in the event the communication fails before announcing a communication failure.

Configuring a Serial Port

1. On the Connection tab, select a COM port from the “Device” box, and then click Configure.

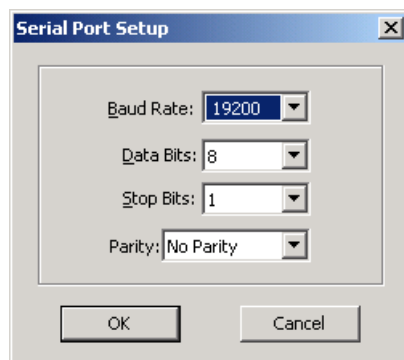

2. Specify the baud rate and data format for the port. Choose the same baud rate and data format as you have set in the device, and then click OK.

Communicating through a Modem (future)

Selecting the Communications Protocol

On the Connection tab, click Protocol, and then select the protocol settings as shown above for a serial port.

Configuring a Modem

1. On the Connection tab, select from the “Device” box a local modem installed on your PC through which you communicate with your device.
2. Click on Phones to add the phone number of the remote device to the phone list.
3. Type the phone number in the “Phone number” box, add comments if you desire, click Add, and then click OK.
4. From the “Phone number” box on the Connection tab, select the phone number from the list, and then click OK.

Communicating through the Internet

1. Click on the Connection tab.
2. Click on the “IP address” and type in the IP address of the PM180.
3. In the “Protocol” box, select the communications protocol for the TCP port. PAS automatically adjusts the TCP port number in the “Host Port” box, corresponding to the selected protocol. Use the following references to check the TCP port setting:

502	-	Modbus RTU
20000	-	DNP3.0
2404	-	IEC 60870-5

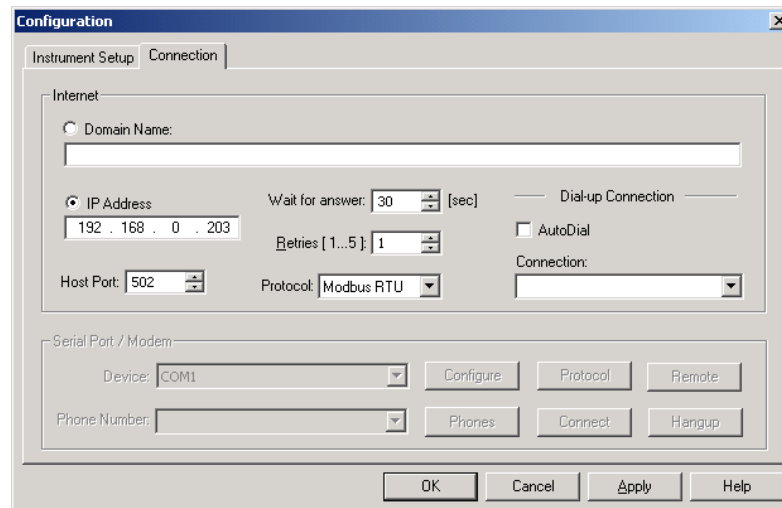

4. You can also adjust the amount of time that PAS waits for a connection before announcing an error and the number of retries PAS uses to receive a response from the device if communications fail.

Communicating through a CELLULAR (GPRS-2G or 3G) Modem

Configuring a Dial-up CELLULAR (GPRS-2G or 3G) Connection

To communicate through a CELLULAR modem:

1. On the Instrument Setup tab, select Internet Site.
2. Click on the Connection tab.

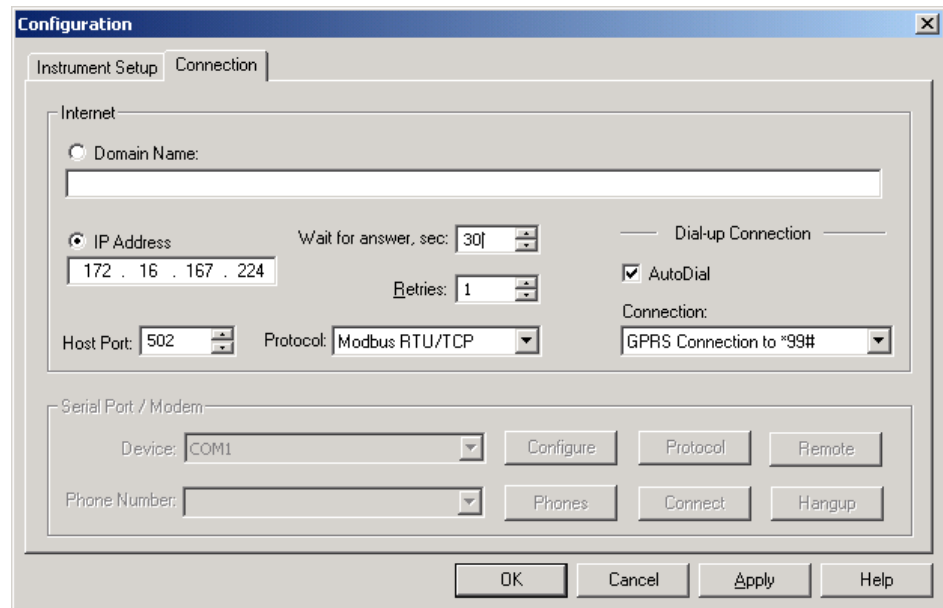

3. Click on the “IP address” and type in the IP address your meter got from the CELLULAR provider when registering on the CELLULAR network. You can find the meter CELLULAR IP address on the GPRS page in the Device Info display (see [Device Info Display](#) in Chapter 3) or via the Dial-Up Networking setup dialog in PAS (see Modem/GPRS IP Address in [Setting-Up Dial-Up GPRS Network](#) in Chapter 5)
4. In the “Protocol” box, select the communications protocol for the PM180 GPRS TCP port. The host port is set automatically as you select the protocol. Select “Modbus RTU/TCP” for Modbus/TCP, or “DNP3” for DNP3/TCP.
5. In the “Wait for answer” box, adjust the time that PAS should wait for a connection before announcing an error and the number of retries that PAS should use to receive a response from the device if communications fail.
6. In the “Connection” box, select the Dial-up connection you created for the PM180. See Dial-Up Networking for information on how to create a Dial-up connection in Windows.
7. Check the AutoDial box, if you wish PAS to automatically connect to your meter every time you access it from PAS; otherwise you must manually dial your connection.

Communicating through a USB

On the Instrument Setup tab, click USB Port, and then click OK.

Setting Up the Device

Creating Setups for the Device

PAS allows you to prepare setup data for your device off-line without the need to have it connected to your PC.

Select the device site from the list box on the PAS toolbar, and then select the desired setup group from the Meter Setup menu. Click on the tab with the setup you want to create or modify and fill in the boxes with the desired configuration data for your device. Click the “Save as...” button to store the data to the site database.

Note

Always set up and store the Basic Setup data to the site database first. PAS uses this data as a reference when arranging other device setup.

To save your setup to another site database, select it from the file pane. Click OK.

Copying Setups to the Device Database

To reuse setups from another site, you can simply copy them to your present site database. Click Open, select the desired site database, and then click OK. The opened setup is copied to your site database.

You can also copy all setups from one site database into another site's database. Select a device site from the list box on the toolbar from which you want to reproduce setups, and then select "Copy to..." from the Meter Setup menu. Select the site database to which to copy setups, and then click OK.

Downloading Setup to the Device

PAS allows you to update each setup in your device one at time or to download all setups together from the site database.

To update a particular setup in your device, check the On-line button  on the PAS toolbar, select a device site from the list box, and then select the desired setup group from the Meter Setup menu. Click on the tab of the setup you want to download to the device, and then click Send.

To download all setups to your device at once, check the On-line button  on the PAS toolbar, select the device site from the list box, and then select Download Setups from the Meter Setup menu.

Uploading Setup from the Device

To upload the setup from the device to the site database, check the On-line button  on the PAS toolbar, select the device site from the list box, and then select Upload Setups from the Meter Setup menu.

Chapter 6 Programming the PM180

This chapter describes how to configure the PM180 for your particular environment and application using PAS. To access your device configuration options, you should create a site database for your device as shown in Chapter 6.

Authorization

If the device is password protected (see [Access Control Menu](#) in Chapter 3 and [Changing the Password and Security](#) in Chapter 3), you are prompted for the password when sending the new setup data to the device.

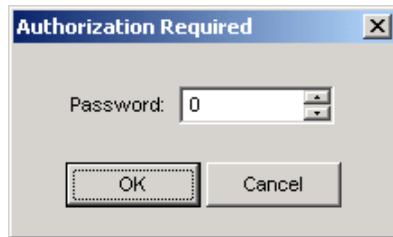

Enter the password and click OK. If your authorization was successful, you are not prompted for the password again until you close the dialog window.

Changing Port Settings

Setting Up Communication Ports

To enter the setup dialog, select the site from the list box on the PAS toolbar, select Communications Setup from the Meter Setup menu, and then click on the Serial Ports Setup tab. In the Port box, select the desired device port.

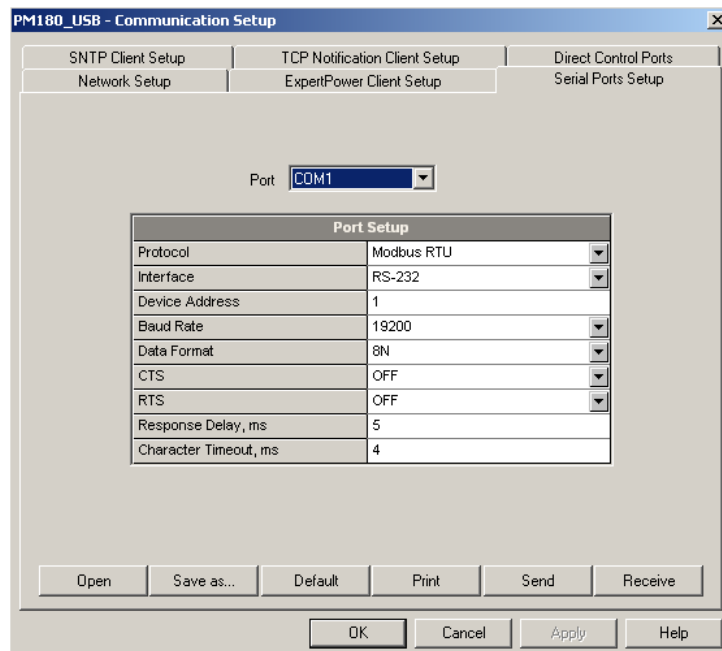

To change the port settings in your device, select desired port parameters, and then click Send. For the available communication options, see [Communication Setup Menus](#) in Chapter 3.

Setting Up the ETHERNET - Local Network

To enter the setup dialog, select the device site from the list box on the PAS toolbar, select Communications Setup from the Meter Setup menu, and then click on the Network Setup tab.

To change the Ethernet settings in your device, select desired parameters, and then click Send. For more information, see [Configuring the Network](#) in Chapter 3.

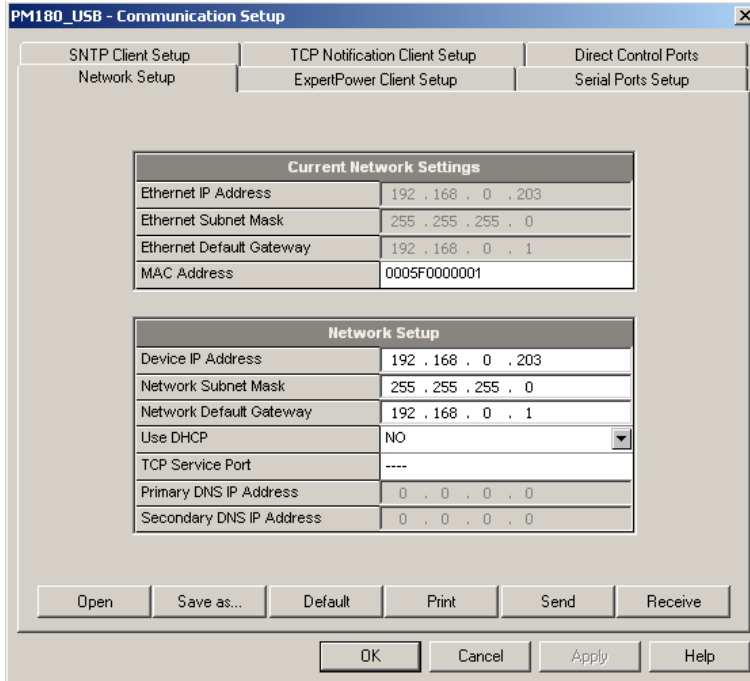

Setting-Up CELLULAR - Public Network

Select Communications Setup from the Meter Setup menu, and then click on the Dial-Up Networking Setup tab.

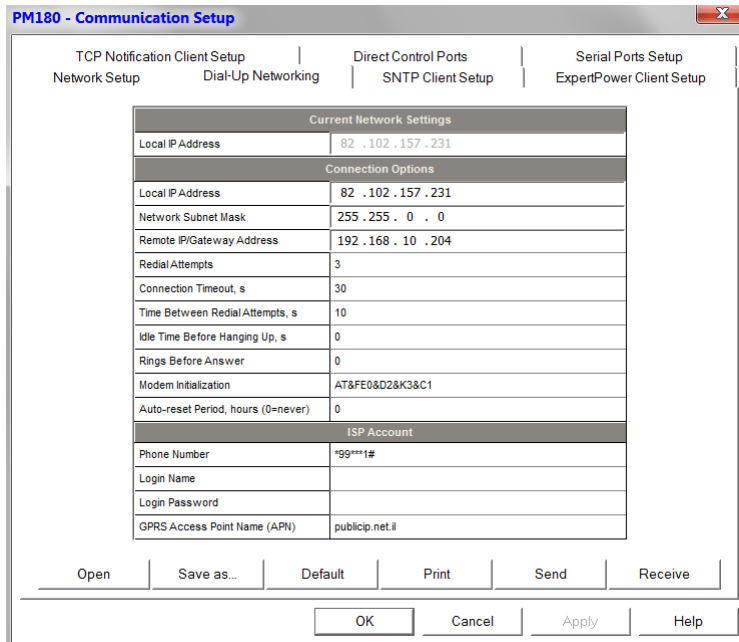

The following table lists available connection options.

Parameter	Options	Default	Description
-----------	---------	---------	-------------

Parameter	Options	Default	Description
Connection Options			
IP Address		192.168.10.203	The IP address on the dial-in modem PPP network. Not used in a GPRS network.
Network Mask	Subnet	255.255.0.0	The PPP/GPRS network subnet mask
Network Gateway	Default	192.168.10.204	The PPP network default gateway. Not used in a GPRS network.
Redial Attempts	0-1000, 0 = forever	0	The number of dial attempts to connect to a remote modem if a connection was unsuccessful.
Connection Timeout	0-9999 sec	120	The modem cancels a call if not connected within the connection timeout time.
Time Between Redial Attempts	0-9999 sec	60	A time delay between redials.
Idle Time Before Hanging Up	0-9999 sec 0 = never	0	The modem disconnects a call if idle for more than the specified idle time.
Rings before Answer	0-99 0 = never	0	The number of rings before the modem answers an incoming call from a remote modem. Not used in a GPRS network.
Modem Initialization		AT&F&D1&C1	Default modem initialisation string. Do not change.
ISP Account			
Phone Number		*99#	The telephone number of the ISP provider. The default number provides a connection to the GPRS network for your PM180 GSM/GPRS modem.
Login Name			Login name for logging onto the Internet (if required).
Login Password			Login password for logging onto the Internet (if required).
GPRS Access Point Name (APN)		internet	The mobile network APN name (consult with your network operator)

Note

Do not change the default modem connection options. Consult with your GPRS network operator if the network subnet mask needs to be extended.

Setting-Up SNTP Client

Select Communication Setup from the Meter Setup menu, and then click on the SNTP Client Setup tab.

The SNTP client can provide periodic synchronization of the meter clock with a publicly available SNTP server or with your local server if it supports this service.

To allow clock synchronization via SNTP, select SNTP as a clock synchronization source in [Local Settings](#).

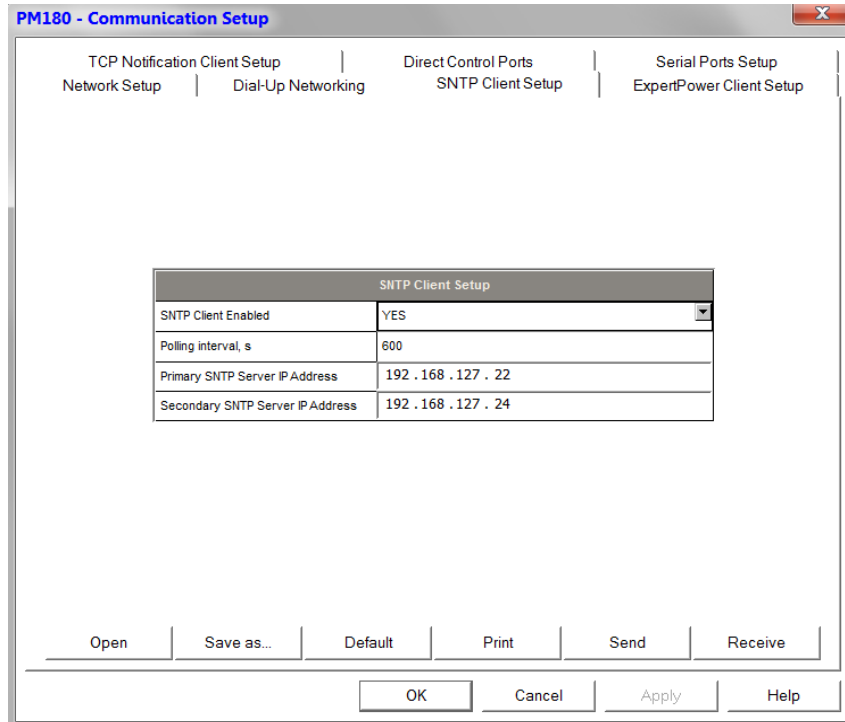

The following table lists available options

Parameter	Options	Default	Description
SNTP Client Enabled	NO, YES	NO	Enables operations of the SNTP client
Polling interval, s	60-86400 s	600 s	The time remaining requesting time from the SNTP server
Primary SNTP Server IP Address		192.36.143.151	The IP address of the primary SNTP server
Secondary SNTP Server IP Address		130.149.17.21	The IP address of a secondary SNTP server in the event of temporary unavailability of the primary server

The default SNTP server IP addresses belong to Stockholm and Berlin university servers.

Configuring eXpertPower Client

The PM180 has an embedded eXpertPower™ client that provides communications with the eXpertPower™ server – the SATEC proprietary Internet services. Connections to the eXpertPower™ server are handled on a periodic basis.

To enter the Setup dialog, select the site from the list box on the PAS toolbar, select Communication Setup from the Meter Setup menu, and then click on the ExpertPower Client Setup tab.

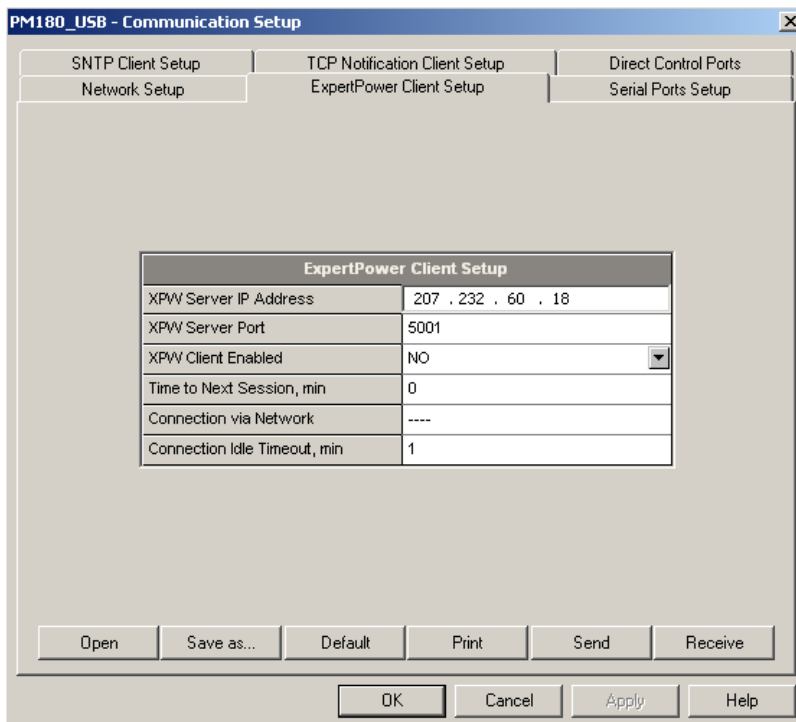

The following table lists available options. Refer to your eXpertPower service provider for the correct eXpertPower settings.

Parameter	Options	Default	Description
XPW Server IP Address		207.232.60.18	The IP address of the eXpertPower server
XPW Server Port	0-65535	5001	The TCP service port of the eXpertPower server
XPW Client Enabled	NO, YES	NO	Enables operations of the eXpertPower client
Time to Next Session, min	1-99999		The time remaining to the next connection session

NOTES:

1. If you do not use the eXpertPower™ service, do not enable the eXpertPower client in your device.
2. Do not change the connection period setting. The eXpertPower server updates it automatically.

Basic Device Setup

Before operating your device, define the basic information about your electrical network. To enter the setup dialog, select the device site from the list box on the PAS toolbar, and then select General Setup from the Meter Setup menu.

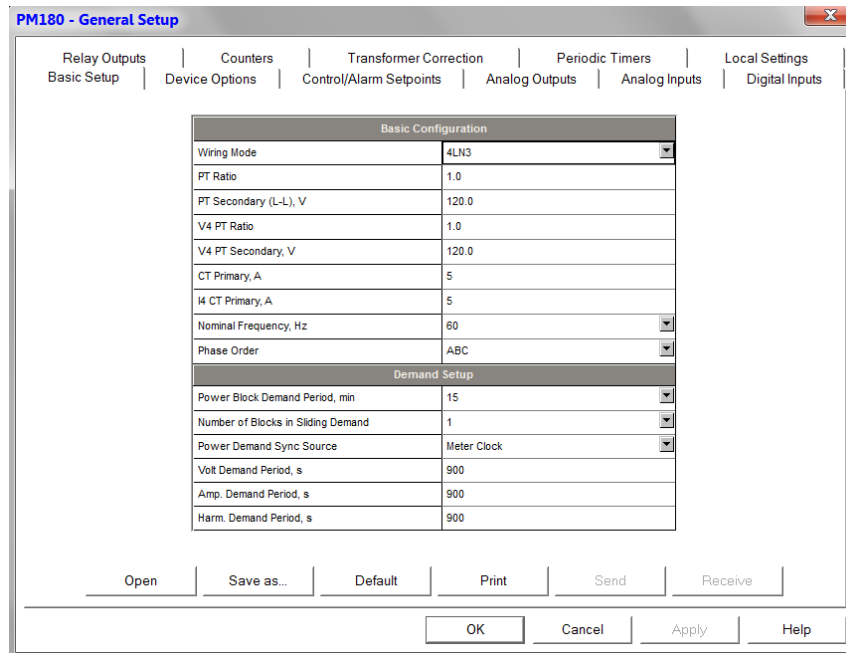

The following table lists available device configuration options.

Option	Range	Default	Description
Basic Configuration			
Wiring connection mode (configuration)	See "Wiring Connections" below	4LN3	The wiring connection of the device
PT ratio ¹ V1-V3 voltage inputs	1.0 - 6500.0	1.0	The phase potential transformer ratio (primary to secondary ratio)

¹ PT Ratio is defined as a relation of the potential transformer's primary voltage rating to its secondary rating. For example, if your potential transformer's primary rating is 14400V and the secondary rating is 120V, then the PT Ratio = 14400/120 = 120

Option	Range	Default	Description
PT secondary (L-L), V	10-690 V	120	The phase potential transformer's secondary phase-to-phase voltage
V4 PT ratio	1.0 - 6500.0	1.0	The V4 potential transformer ratio (primary to secondary ratio)
V4 PT secondary, V	10-690 V	120	The V4 potential transformer's secondary voltage
CT primary, A I1-I3 current inputs	1-10000 A	5	The primary rating of the phase current transformer on standard (20A/10A) inputs
I4 CT primary, A current	1-10000 A	5	The primary rating of the I4 current transformer on standard (20A/10A) inputs
I4 CT secondary current	1, 5 A	5	The secondary rating of the I4 current transformer on standard (20A/10A) inputs
Nominal frequency, Hz	50, 60 Hz	50 (60 for North America)	The nominal power frequency
Phase order	ABC, CBA	ABC	The normal phase sequence
Demand Setup			
Power Block demand period, min	1, 2, 5, 10, 15, 20, 30, 60	15	The length of the demand period for power demand calculations
Number of Blocks in sliding window	1-15	1	The number of demand periods to be averaged for sliding window demands
Power demand sync source	Meter clock, DI1-DI48 (digital inputs 1-48)	Meter clock	The source input for synchronization of the demand intervals. If a digital input is specified as the source, a pulse front denotes the start of the demand interval
Volt demand period, s	0 - 9000 sec	900	The length of the demand period for ampere demand calculations
Amp. demand period, s	0 - 9000 sec	900	The length of the demand period for volt demand calculations
Harm. demand period	0 - 9000 sec	900	The length of the demand period for harmonic demand calculations

Wiring Connections

Available wiring modes are listed in the following table:

Wiring Mode	Description
3OP2	3-wire Open Delta using 2 CTs (2 element)
4LN3	4-wire Wye using 3 PTs (3 element), line-to-neutral voltage readings
3DIR2	3-wire Direct Connection using 2 CTs (2 element)
4LL3	4-wire Wye using 3 PTs (3 element), line-to-line voltage readings
3OP3	3-wire Open Delta using 3 CTs (2½ element)
3LN3	4-wire Wye using 2 PTs (2½ element), line-to-neutral voltage readings
3LL3	4-wire Wye using 2 PTs (2½ element), line-to-line voltage readings
3BLN3	3-wire Broken Delta using 2 PTs, 3 CTs (2½-element), line-to-neutral voltage readings
3BLL3	3-wire Broken Delta using 2 PTs, 3 CTs (2½-element), line-to-line voltage readings

In 4LN3, 3LN3 and 3BLN3 wiring modes, the voltage readings for min/max volts and volt demands represent line-to-neutral voltages; otherwise, they will be line-to-line voltages. The voltage waveforms and harmonics in 4LN3, 3LN3 and 3BLN3 wiring modes represent line-to-neutral voltages; otherwise, they will show line-to-line voltages.

Device Options

This setup allows you to enable or disable optional calculations and change user-selectable device options.

To enter the setup dialog, select the device site from the list box on the PAS toolbar, select General Setup from the Meter Setup menu, and then click on the Advanced Setup tab.

The following table lists available device options.

Option	Range	Default	Description
Power/Energy Options			
Power calculation mode	S=f(P, Q) (using reactive power), Q=f(S, P) (using non-active power)	S=f(P, Q)	The method used for calculating reactive and apparent powers (see "Power Calculation Modes" below)
Energy roll value	10,000 kWh 100,000 kWh 1,000,000 kWh 10,000,000 kWh 100,000,000 kWh 1,000,000,000 kWh	1,000,000,000	The value at which energy counters roll over to zero
Energy Decimal Places	0, 1, 2, 3, 4	0	
TDD Setup			
I Max. Load Current, A	0 - 10000 A	CT	The maximum demand load current for common current inputs (0 = CT primary)
I4 Max. Load Current, A	0 - 10000 A	CT	The maximum demand load current for I4 (0 = CT primary)
Test Mode			
Energy LED pulse rate, Wh/impulse	0.01-100.00	0.10 Wh/pulse	LED pulse constant - the amount of accumulated energy (in secondary readings) giving one pulse via "kWh" and "kvarh" LEDs.
Energy LED Test	Disabled, Wh Pulses, varh Pulses	Disabled	LED located in RDM and RGM, for energy measurement calibration
Data Scales			
Volts Scale, V	10-828 V	828 V	The maximum voltage scale allowed, in secondary volts. See Data Scales in Appendix E.
Amps Scale, A	1.0-20.0 A	20	The maximum current scale allowed, in secondary amps. See Data Scales in Appendix E.

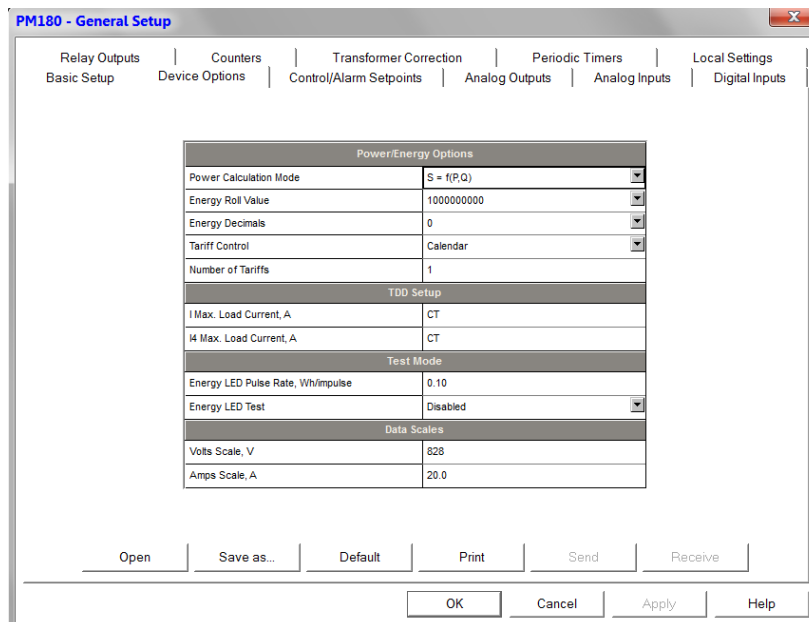

Power Calculation Modes

The power calculation mode option allows you to change the method for calculating reactive and apparent powers in presence of high harmonics. The options work as follows:

1. When the reactive power calculation mode is selected, active and reactive powers are measured directly and apparent power is calculated as:

$$S = \sqrt{P^2 + Q^2}$$

This mode is recommended for electrical networks with low harmonic distortion, commonly with THD < 5% for volts, and THD < 10% for currents. In networks with high harmonics, the following method is preferable.

2. When the non-active power calculation mode is selected, active power is measured directly, apparent power is taken as product $S = V \times I$, where V and I are the RMS volts and amps, and reactive power (called non-active power) is calculated as:

$$N = \sqrt{S^2 - P^2}$$

Tariff Control

The PM180 provides three options for switching tariff rates:

1. automatic via a programmable TOU calendar schedule (see [Configuring the Daily Tariff Schedule](#) for information on configuring tariff change points)
2. external via communications by writing a tariff number to the meter tariff register (see the EM720 Modbus Reference Guide for information on the active tariff register location)
3. external via digital inputs by providing a tariff code on the meter tariff inputs

If a digital input option is selected, you can use 1 to 3 consequent digital inputs as tariff inputs. The following table shows the number of inputs required depending on the maximum number of used tariff rates.

Number of tariffs	Number of tariff inputs
2	1
3	2
4	2
5	3
6	3
7	3
8	3

The following table shows code combinations that should be provided on the tariff inputs to indicate an active tariff rate.

Tariff rate number	Tariff code		
	Tariff input 1	Tariff input 2	Tariff input 3
1	Open	Open	Open
2	Closed	Open	Open
3	Open	Closed	Open
4	Closed	Closed	Open
5	Open	Open	Closed
6	Closed	Open	Closed
7	Open	Closed	Closed
8	Closed	Closed	Closed

Instrument Transformer Correction Setup

Transformer correction allows you to compensate ratio and phase angle inaccuracies of the voltage and current instrument transformers.

Select General Setup from the Meter Setup menu, and then click on the Transformer Correction tab.

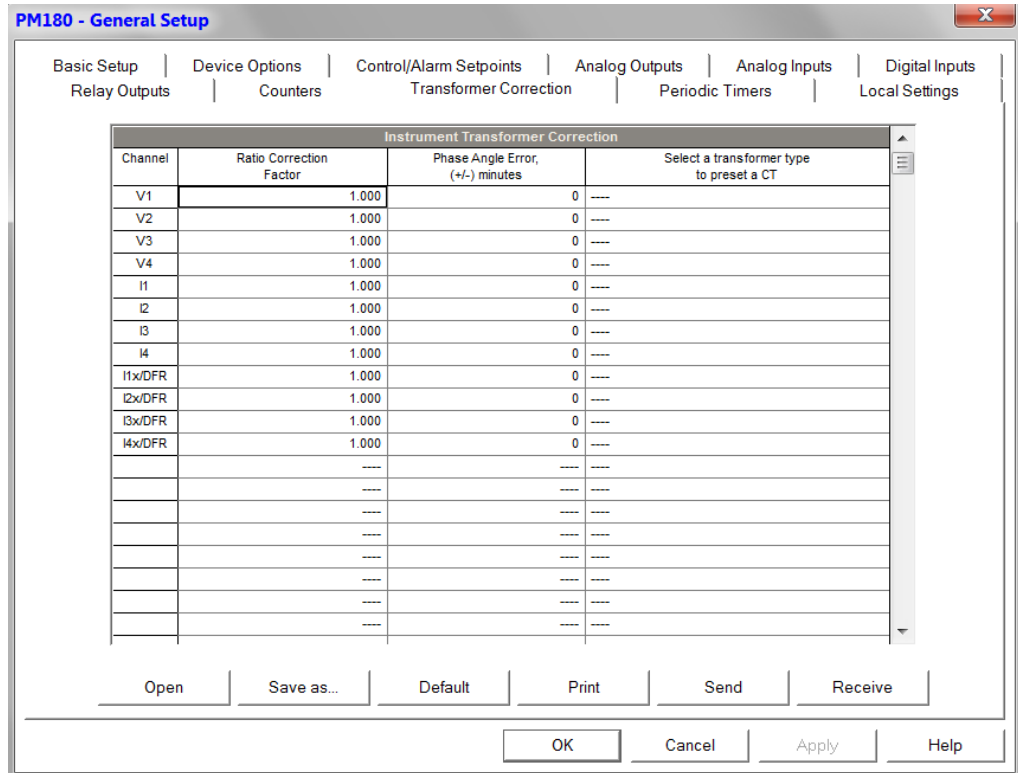

The available options are listed in the following table.

Parameter	Options	Description
Channel	None, V1-V4, I1-I4, I1x/DFR-I4x/DFR	Voltage/ measurement current and current fault recorder channels
Ratio Correction Factor	0.900-1.100	The ratio of the true transformer ratio to the marked ratio
Phase Angle Error	+/-600 minutes	The phase displacement, in minutes, between the primary and secondary values. The phase angle of a transformer is positive when the secondary value leads the primary value.

You define linearity error and phase angle shift error based on the transformer’s accuracy characteristics. The compensation is applied over the full operating range of the transformer.

Local Settings

This setup allows you to select the external time synchronization source and daylight savings time options.

To configure the local time options in your device, select the device site from the list box on the PAS toolbar, select General Setup from the Meter Setup menu, and then click on the Local Settings tab.

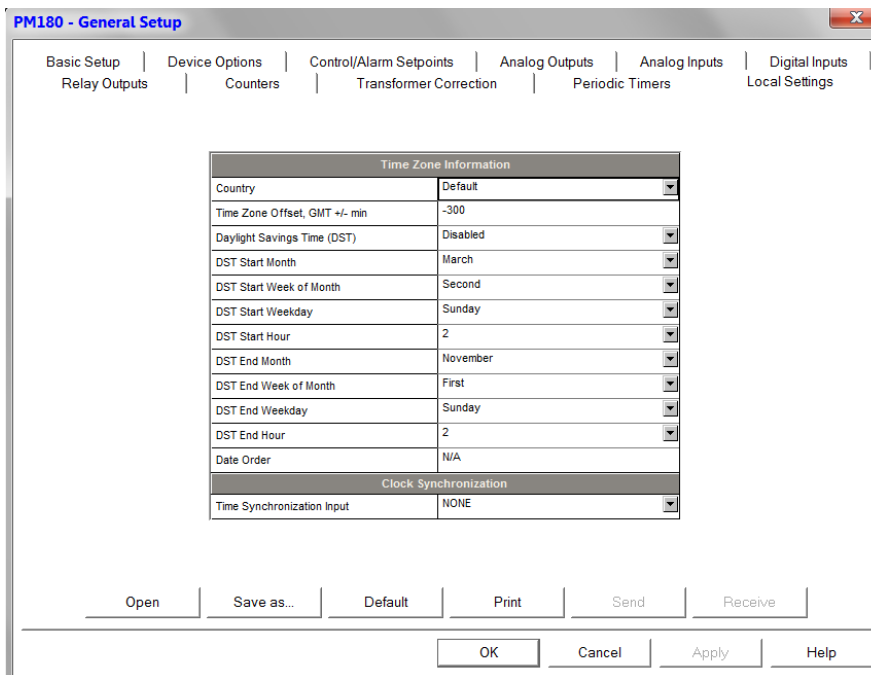

The available options are described in the following table:

Option	Format/Range	Default	Description
Time Zone Information			
Time zone offset, GMT +/- min	-720 to 720 min	-300 (Eastern Time)	Local offset in minutes from UTC (Universal Coordinated or Greenwich Mean Time). It is used to produce a local time from the GPS IRIG-B time code.
Daylight Savings Time (DST)	Disabled Enabled	Disabled	When DST is disabled, the RTC operates in standard time only. When enabled, the device automatically updates the time at 2:00 AM at the pre-defined DST switch dates.
DST start month DST start week DST start weekday DST Start Hour	Month-week-weekday-hour Month = Jan-Dec Week = 1 st , 2 nd , 3 rd , 4 th or Last (last week of the month) Day = Mon-Sun Hour = 1-6	March Second Sunday 2	The DST start date when Daylight Savings Time begins. The DST switch point is specified by the month, week of the month and weekday. By default, DST starts at 2:00 AM on the first Sunday in April of each year.
DST end month DST end week DST end weekday DST end Hour	Month-week-weekday-hour Month = Jan-Dec Week = 1 st , 2 nd , 3 rd , 4 th or Last (last week of the month) Day = Mon-Sun Hour = 1-6	November First Sunday 2	The DST end date when Daylight Savings Time ends. The DST switch point is specified by the month, week of the month and weekday. By default, DST ends at 2:00 AM on the last Sunday in November of each year.
Clock Synchronization			
Time synchronization input	GPS IRIG-B, SNTP, DI1-DI48 (digital input 1-48)	GPS IRIG-B	The external port receiving the time synchronization signal. If no external synchronization is used, set this option to IRIG-B: when a signal is not present, the PM180 automatically uses internal RTC clock for time synchronization.

Time Synchronization Source

The PM180 receives the time synchronization signal either from a GPS clock having an IRIG-B time-code output, or from an external device giving a pulse at the beginning of the minute. If the IRIG-B option is selected but the IRIG-B signal is not present on the device input, the PM180 automatically uses its internal RTC clock.

Using the IRIG-B

To use the IRIG-B input, select the GPS IRIG-B option and connect the GPS master clock to the IRIG-B BNC connector on the front of the PM180 IRIG-B Module or to CPU IRIG-B terminal¹.

When the IRIG-B signal is present on the device input, the PM180 automatically synchronizes its clock with the GPS time each second, normally with accuracy better than 1 millisecond if the time is locked to the GPS satellite time. If the GPS clock loses the satellite signal, the clock continues to generate the IRIG-B time code referenced to the last available satellite time, but the time quality may get worse. Such signal losses can last from a few minutes to hours. During such outages the time code generated by the GPS receiver is typically accurate to within a few milliseconds over a 24-hour period.

You can check presence and quality of the IRIG-B signal through the RDM from the [Clock Setup Menu](#), through HyperTerminal (see [Testing the GPS Master Clock](#) in Chapter 3) and via the [Device Diagnostics](#).

If the IRIG-B signal is lost, the PM180 changes the time synchronization source to the internal RTC in 5 minutes. When the IRIG-B signal is restored, the device automatically acquires the GPS time.

If the IRIG-B signal is lost or time code quality changes (locked to the GPS satellite time or unlocked), the corresponding events are automatically recorded to the device Event log.

Using SNTP

Enable SNTP client operation and configure it if required (see Setting-Up SNTP Client).

When an SNTP server is not available or when a connection with a server is restored, the corresponding event is automatically recorded to the device Event log.

Using External Minute Pulses

External time synchronization pulses are delivered through one of the PM180 digital inputs. If the digital input is selected as the time synchronization source, the external pulse's edge adjusts the device clock at the nearest whole minute. The time accuracy is affected by the debounce time programmed for the digital input, and by the operation delay of the external relay.

Daylight Savings Time

The daylight savings time option is enabled in the PM180 by default, and the default daylight savings time change points are set for the U.S.A. When the daylight savings time is enabled, the PM180 automatically adjusts the device clock at 02.00 AM when daylight savings time begins/ends.

If the daylight savings time option is disabled, you need to manually adjust the device clock for daylight savings time.

¹ Available in PM180 N3 Version only

Configuring Digital Inputs

The PM180 supports up to three expansion Digital Input (DI) modules with a total of 48 digital inputs (DI1 to DI48). I/O numbers are automatically assigned to the inputs in the order of connection when the device is powered up. For example, if two DI modules are connected to the device, the digital inputs DI1-DI16 belong to the first module, and DI17-DI32 - to the following module. If you insert an I/O module into another slot position and do not change its order, then all digital inputs on the module retain their I/O numbers.

To configure the digital inputs in your device, select the device site from the list box on the PAS toolbar, select General Setup from the Meter Setup menu, and then click on the Digital Inputs tab. The digital inputs that are not present in your device are designated as not available.

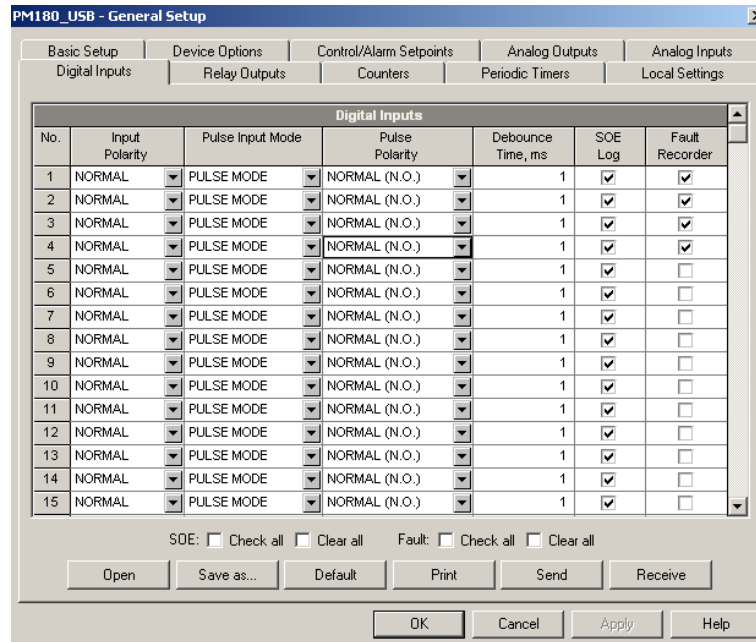

The available options are described in the following table:

Option	Range	Default	Description
Input Polarity	NORMAL, INVERTING	NORMAL	Defines the input polarity state
Pulse Input Mode	PULSE MODE KYZ MODE	PULSE MODE	Defines the type of a pulse on the input when it receives external pulses. In pulse mode, either leading, or trailing edge of the input pulse is accepted. In KYZ mode, both leading and trailing edges of the input pulse are accepted.
Pulse polarity	NORMAL (N.O.) INVERTING (N.C.)	NORMAL	Selects the active pulse edge that is considered a pulse in pulse mode. For normal polarity, the open to closed transition is considered a pulse. For inverting polarity, the closed to open transition is considered a pulse. It has no meaning in KYZ mode where both transitions are active.
Debounce time, ms	1-100 ms	1	The amount of time the state of the digital input should not change before being accepted as a new state. Too low debounce time could produce multiple events on the input change.
SOE Log	Checked Unchecked	Unchecked	When the box is checked, either transition on the digital input is recorded to the Sequence-of-Events log.
Fault Recorder	Checked Unchecked	Unchecked	When the box is checked, a positive transition on the digital input (open to closed transition event) triggers the Fault recorder.

Debounce Time

The debounce time is assigned to digital inputs in groups of 8 adjacent inputs. So, DI8 has the same debounce time as inputs DI1 through DI7, while DI9 through DI16 are allowed to have another debounce time setting. When you change the debounce time for one digital input, the same debounce time is automatically assigned to all inputs related to the same debounce group.

Recording Digital Input Events to the Sequence-of-Events Log

To log transition events on digital inputs into the Sequence-of-Events log, you only need to check the SOE log boxes for the digital inputs you want to be recorded. If you link a digital input to the Fault recorder, it is automatically connected to the SOE log. The pulse mode settings do not affect the SOE log.

Each digital input is recorded to the SOE log independently. A timestamp is typically accurate to within 1 ms at 60Hz and 1.25 ms at 50Hz. The debounce time is included in the timestamp.

Triggering the Fault Recorder through Digital Inputs

Any digital input can trigger the Fault recorder if its Fault recorder box is checked. When an open-to-closed state transition is detected on the digital input, the global “External Trigger” event is generated in the device. If the Fault recorder is enabled (see [Device Mode Control](#)), it triggers the Fault recorder to record waveforms or RMS data for the event.

When a number of digital inputs linked to the Fault recorder generate events at the same time, only the first of them triggers the Fault recorder and logs a fault event into the Fault log file. The next external fault event is not triggered until all the digital inputs linked to the Fault recorder are released, but all operations on digital inputs are automatically recorded to the Sequence-of-Events log. This does not affect operations of the internal analog fault triggers that work independently.

Notice that the “External Trigger” event can also be tested through the control setpoints from the “Static Events” trigger group to trigger another action on your selection.

Programming Relay Outputs

The PM180 supports up to three expansion Relay Output (RO) modules with a total of 24 relays (RO1 to RO24). I/O numbers are automatically assigned to the relay outputs in the order of connection when the device is powered up.

The PM180 allows you to program all relay outputs regardless of whether they are actually present in your device or not. The relays that are not present in the device are considered “virtual” relays and can be used in the same way as real relays with the only difference that they cannot transmit signals outside of the device. The “virtual” relays may be with the control setpoints as temporary event storage to transfer events between setpoints.

Each relay can be operated either locally from the control setpoints in response to an internal or external event, or by a remote command sent through communications, or can be directly linked to an internal pulse event produced by the device.

To configure the relay outputs in your device, select General Setup from the Meter Setup menu, and then click on the Relay Outputs tab.

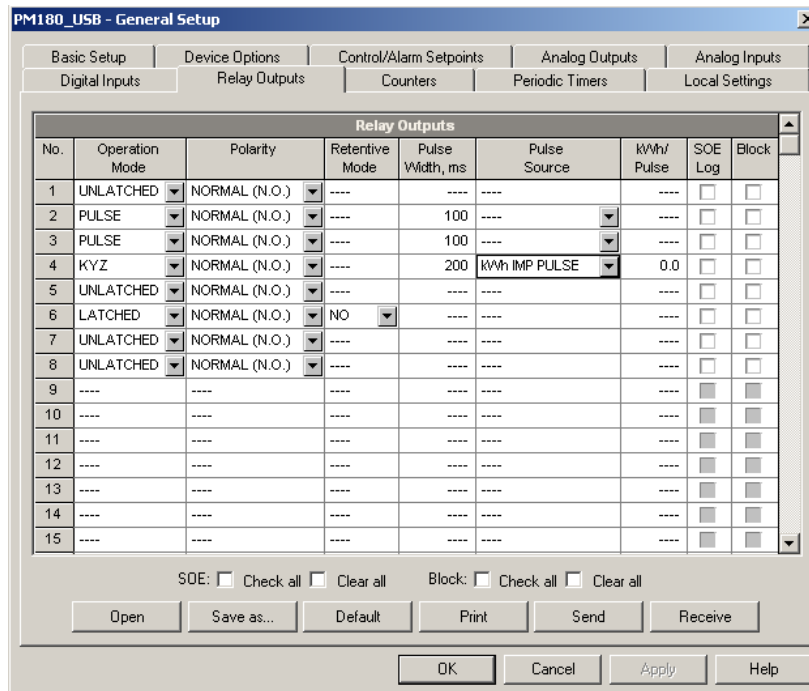

The available relay options are described in the following table:

Option	Format/Range	Default	Description
Operation Mode	Unlatched Latched Pulse KYZ	Unlatched	<p>Defines the behavior of the relay in response to local and remote commands</p> <p>Unlatched mode: the relay goes into its active state when the control setpoints is in active (operated) state, and returns into its non-active state when the setpoints is released.</p> <p>Latched mode: the relay goes into its active state when the control setpoints goes into active state and remains in the active state until it is returned into its non-active state by another setpoints or by a remote command.</p> <p>Pulse mode: the relay goes into its active state for the specified time, goes into non-active state for the specified time and remains in the non-active state.</p> <p>KYZ mode: the relay generates transition pulses. The relay changes its output state upon each command and remains in this state until the next command.</p>

Option	Format/Range	Default	Description
Polarity	NORMAL (N.O.) Inverting (N.C.)	Normal	Defines whether the relay is energized or de-energized in its non-active and active (operated) states. With normal polarity, the relay is normally de-energized in its non-active state and is energized in its active (operated) state. With inverting polarity, the relay is normally energized in its non-active state and is de-energized in its active (operated) state. It is called sometimes failsafe relay operation.
Retentive mode	Checked Unchecked	Unchecked	This option is only applicable for latched relays. Normally, when retentive mode is OFF, the relay is always returned into its non-active state upon power up. If the relay is set to be retained, the device restores its status to what it was prior to loss of power.
Pulse width	10-1000 ms	100 ms	The amount of time the pulse relay stays in active state when generating a pulse. The actual pulse width is a multiple of the 1/2-cycle time rounded to the nearest bigger value. The minimum pause time between pulses is equal to the pulse width.
Pulse source	None kWh IMP PULSE kWh EXP PULSE kWh TOT PULSE kvarh IMP PULSE kvarh EXP PULSE kvarh TOT PULSE kVAh TOT PULSE DMD INTRVL SW DMD INTRVL AMP DMD INTRVL TARIFF INTRVL	---	Links the pulse relay to the internal pulse event that is to be retransmitted through the relay output as a pulse with a predefined width. The relay must be set into either pulse, or KYZ mode.
kWh/Pulse	0.1-1000.0 1.0	0.0 kWh/Pulse	Defines the pulse weight in kWh units per pulse.
SOE Log	Checked Unchecked	Unchecked	When the box is checked, either transition on the relay output is recorded to the Sequence-of-Events log.
Block	Checked Unchecked	Unchecked	

Recording Relay Events to the Sequence-of-Events Log

To log transition events on relay outputs into the Sequence-of-Events log, check the "SOE Log" boxes for the relay outputs you want to be recorded.

Programming Analog Inputs

The PM180 can be equipped with up to three plug-in 4-channel Analog Input/Output (AI/AO) modules. I/O numbers are automatically assigned to the analog inputs in the order of connection when the device is powered up.

The PM180 automatically converts the AI readings received from the analog-to-digital converter to the user-defined engineering scale and shows the input values in true engineering units, for example, in volts, amps, or degrees, with the desired resolution.

To configure the analog inputs in your device, select General Setup from the Meter Setup menu, and then click on the Analog Inputs tab. If you are programming your device online, Analog inputs that are not present in the device are designated as not available.

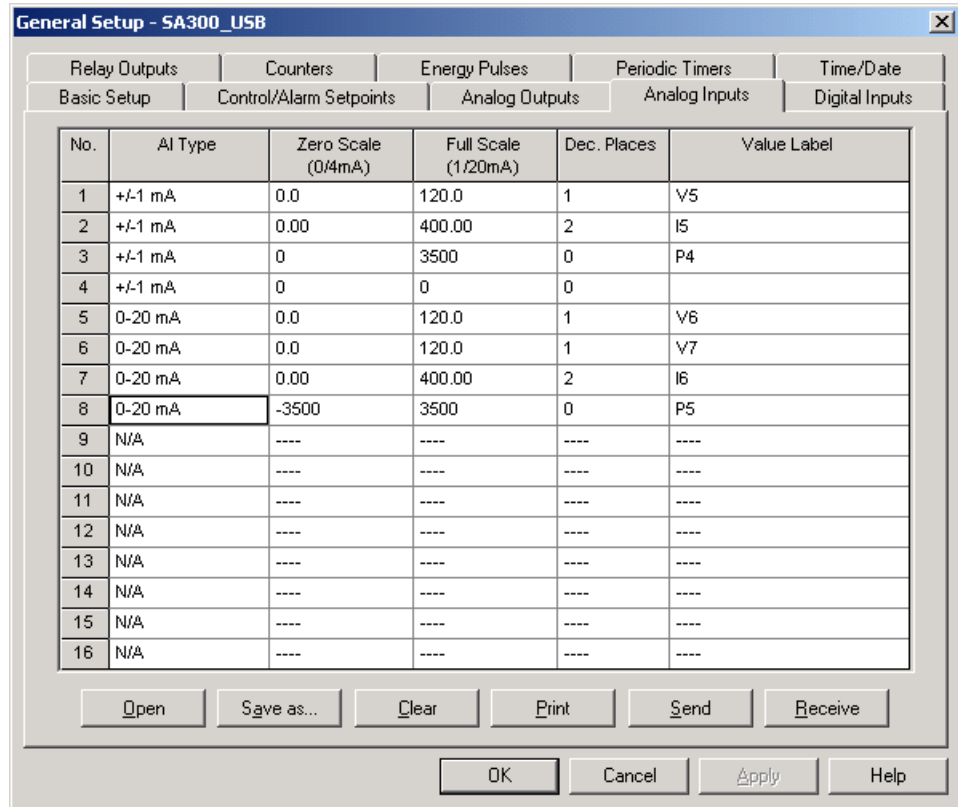

The available AI options are listed in the following table:

Option	Range	Description
AI type	0-1 mA ±1 mA 0-20 mA 4-20 mA 0-50 mA ±10 V	The AI module type. When connected to the device, shows the actual AI type read from the AI module.
Zero scale	0/4 mA	Defines the low engineering scale (in primary units) for the analog input corresponding to a lowest (zero) input current (0 or 4 mA, or 0 V)
Full scale	1/20/50 mA, 10V	Defines the high engineering scale (in primary units) for the analog input corresponding to a highest input current (1, 20 or 50 mA, or 10 V)
Dec. Places		The number of decimal digits in a fractional part of the scaled engineering value
Value label		An arbitrary name you can give the analog input value

NOTE:

Always save your AI setup to the site database in order to keep the labels you gives the analog inputs. They are not stored in your device.

Scaling Non-directional Analog Inputs

When programming scales for non-directional analog inputs with a 0-1mA, 0-20mA or 4-20mA current option, provide both zero and full engineering scales. An example is shown in the picture above for the 0-20 mA analog inputs. Each of the scales operates independently.

Scaling ± 1 mA Analog Inputs

When programming engineering scales for directional ± 1 mA analog inputs, you should provide only the engineering scale for the +1 mA input current. The engineering scale for the 0 mA input current is always equal to zero. The device does not allow you to access this setting. Whenever the direction of the input current is changed to negative, the device automatically uses your full engineering scale settings for +1 mA with a negative sign.

Scaling Analog Inputs for 0-2 mA and ± 2 mA

The input scales for 0-1 mA and ± 1 mA analog inputs are always programmed for 0 mA and +1 mA regardless of the desired input range. If you want to use the entire input range of 2 mA or ± 2 mA, set the analog input scales in your device as follows:

- **0-2 mA:** set the 1 mA scale to 1/2 of the required full scale output for uni-directional parameters, and set the 0 mA scale to the negative full scale and the 1 mA scale to zero for bi-directional parameters;
- **± 2 mA:** set the 1 mA scale to 1/2 of the required full-scale output for both uni-directional and bi-directional parameters.

For example, to convert voltage readings from the analog transducer that transmits them in the range of 0 to 2 mA to the range 0 to 120V, set the full range for the +1 mA analog input to 60V; then the 2 mA reading is scaled to 120V.

Programming Analog Outputs

The PM180 supports up to three expansion Analog Input/Output (AI/AO) modules with a total of 12 analog outputs. I/O numbers are automatically assigned to the outputs in the order of connection when the device is powered up.

To configure the analog outputs in your device, select General Setup from the Meter Setup menu, and then click on the Analog Outputs tab. If you are programming your device online, Analog outputs that are not present in the device are designated as not available.

The available AO options are listed in the following table:

Option	Format/Range	Description
AO type	0-1mA ± 1 mA 0-20mA 4-20mA	The AO module type. When connected to the device, shows the actual AO type read from the AI/AO module.
Output parameter		Selects the measured parameter to be transmitted through the analog output channel (see Appendix A)
Zero scale		Defines the low engineering scale (in primary units) for the analog output corresponding to a lowest (zero) output current (0 or 4 mA)
Full scale		Defines the high engineering scale (in primary units) for the analog output corresponding to a highest output current (1 or 20 mA)

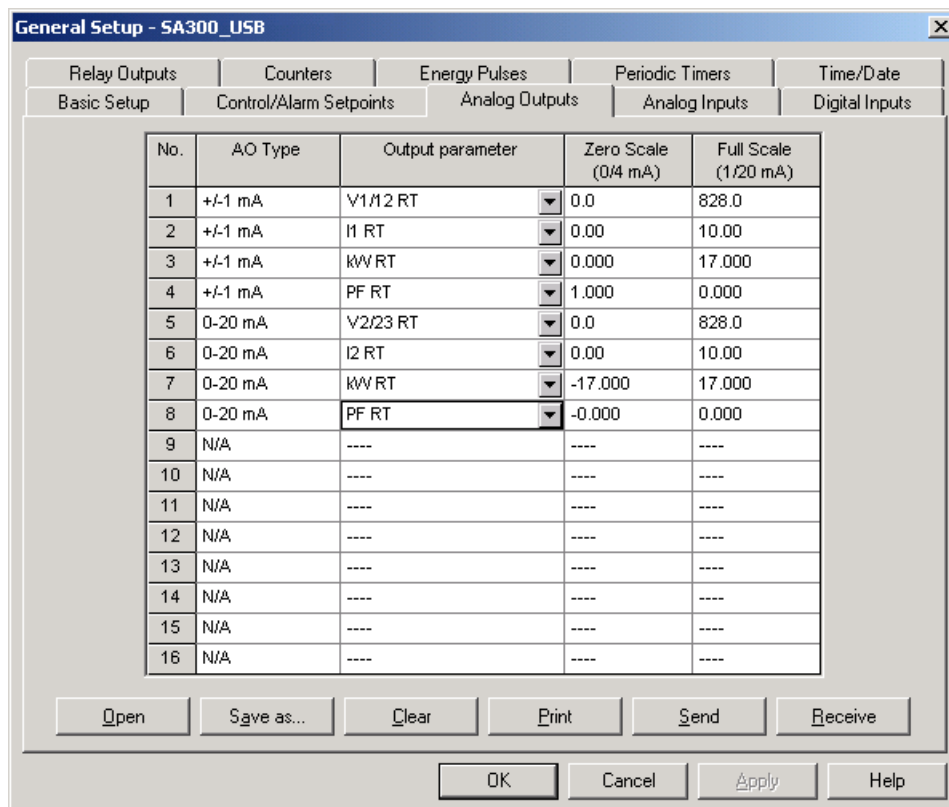

When you select an output parameter for the analog output channel, the default engineering scales are set automatically. They represent the maximum available scales for the parameter. If the parameter actually covers a lower range, you can change the scales to provide a better resolution on the analog output.

Scaling Non-directional Analog Outputs

When programming scales for non-directional analog outputs with a 0-1mA, 0-20mA or 4-20mA current option, you can change both zero and full engineering scales for any parameter. An example is shown in the picture above for the 0-20 mA analog outputs. The engineering scale need not be symmetrical.

Scaling Directional Power Factor

The engineering scale for the signed power factor emulates analog power factor meters. The power factor scale is -0 to +0 and is symmetrical with regard to ± 1.000 ($-1.000 \equiv +1.000$). Negative power factor is scaled as -1.000 minus measured value, and non-negative power factor is scaled as $+1.000$ minus measured value. To define the entire power factor range from -0 to +0, the default scales are specified as -0.000 to 0.000.

Scaling ± 1 mA Analog Outputs

Programming engineering scales for directional ± 1 mA analog outputs depends on whether the output parameter represents unsigned (as volts and amps) or signed (as powers and power factors) values.

If the output value is unsigned, you can change both zero and full engineering scales.

If the parameter represents a signed (directional) value, you should provide only the engineering scale for the +1 mA output current. The engineering scale for the 0 mA output current is always equal to zero for all values except the signed power factor, for which it is set to 1.000 (see "Scaling Directional Power Factor" above). The device does not allow you access to this setting if the parameter is directional. Whenever the sign of the output parameter is changed to negative, the device automatically uses your full engineering scale settings for +1 mA with a negative sign.

Scaling Analog Outputs for 0-2 mA and ±2 mA

The output scales for 0-1 mA and ±1 mA analog outputs are programmed for 0 mA and +1 mA regardless of the desired output current range. To use the entire output range of 2 mA or ±2 mA, set the analog output scales in your device as follows:

- **0-2 mA:** set the 1 mA scale to 1/2 of the required full scale output for uni-directional parameters, and set the 0 mA scale to the negative full scale and the 1 mA scale to zero for bi-directional parameters;
- **±2 mA:** set the 1 mA scale to 1/2 of the required full-scale output for both uni-directional and bi-directional parameters.

For example, to provide the 0 to 2 mA output current range for volts measured by the device in the range of 0 to 120V, set the 1 mA scale to 60V; then the 120V reading is scaled to 2 mA.

Using Counters

The PM180 has 32 nine-digit signed counters that count different events. Each counter is independently linked to any digital input and count input pulses with a programmable scale factor. You can link a number of digital inputs to the same counter. Each counter can be incremented or decremented through the Control Setpoints in response to any internal or external event.

To configure the device counters, select General Setup from the Meter Setup menu, and then click on the Counters tab.

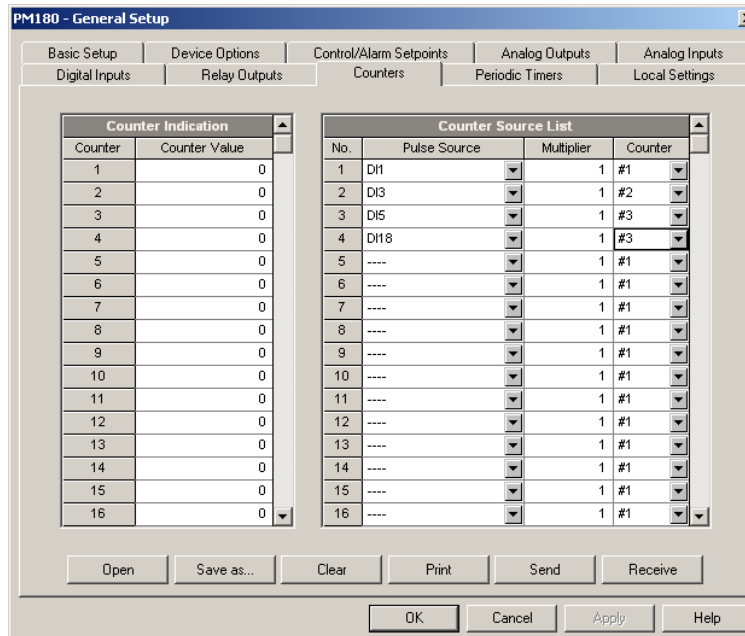

The available options are described in the following table:

Option	Range	Default	Description
Counter Setup			
Counter value	0 - 999,999,999	0	The value written to the counter at reset
Counter Source Setup			
Pulse source	None, DI1-DI48	None	Links a digital input to the counter
Multiplier	1 to 10,000	1	The value added to the counter when a pulse is detected on the pulse source input
Counter	1-32	1	Defines the target counter for the pulse source input

Using Periodic Timers

The PM180 has 16 programmable timers that are used for periodic recording and triggering operations on a time basis through the Control Setpoints. When a pre-programmed timer interval is expired, the timer generates an internal event that can trigger any setpoints (see [Using Control Setpoints](#)). The programmable time interval can be from 1/2 cycle and up to 24 hours.

To configure the device timers, select General Setup from the Meter Setup menu, and then click on the Periodic Timers tab.

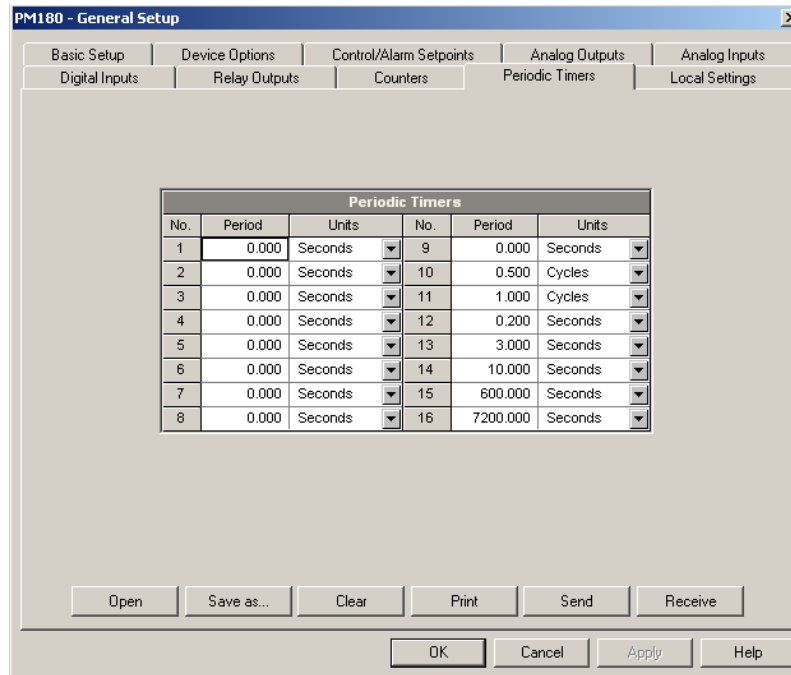

The available options are described in the following table:

Option	Range	Default	Description
Period	0 = disabled 0.010 - 100,000.000 sec 0.500 - 100,000.000 cycles	0	The timer period
Units	Seconds, Cycles	Seconds	The time units

Seven timers from Timer #10 through Timer #16 are factory preset and cannot be re-programmed. They are primarily intended for the use with the Power Quality and Fault recorders. Other timers can be programmed by the user.

To run a periodic timer, select the desired time unit and specify a non-zero time period.

To stop a timer, set the time period to zero.

Using Control Setpoints

The PM180 has an embedded logical controller that runs different actions in response to user-defined internal and external events. Unlike a PLC, the PM180 uses a simplified programming technique based on setpoints that allows the user to define a logical expression based on measured analog and digital values that produces a required action.

The PM180 provides 64 control setpoints with programmable operate and release delays. Each setpoint evaluates a logical expression with up to four arguments using OR/AND logic. Whenever an expression is evaluated as "true", the setpoint performs up to four concurrent actions that can send a command to the output relays, increment or decrement a counter, or trigger a recorder.

To program the setpoints, select General Setup from the Meter Setup menu, and then click on the Control/Alarm Setpoints tab.

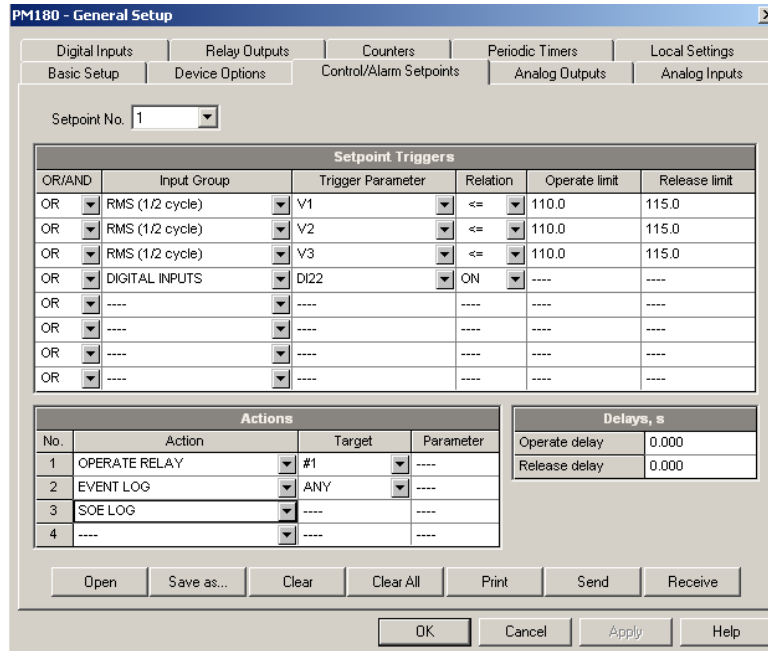

The available setpoints options are described in the following table:

Option	Format/Range	Description
Setpoints Triggers		
OR/AND	OR, AND	The logical operator for the trigger
Input group		The trigger parameter group (see Appendix C)
Trigger parameter		The trigger parameter that is used as an argument in the logical expression (see Appendix C)
Relation	<=, >=, =, <>, Delta, Delta+, Delta-, rDelta, rDelta+, rDelta-	The relational operator used in the conditional expression for the trigger
Operate limit		The threshold (in primary units) at which the conditional expression would be evaluated to true. Not applicable for digital triggers.
Release limit		The threshold (in primary units) at which the conditional expression would be evaluated to false. Defines the hysteresis for analog triggers. Not applicable for digital triggers.
Setpoints Actions		
Action		The action performed when the setpoints expression is evaluated to true (see Appendix B)
Target		The optional action target
Parameter		The optional action argument (reserved)
Delays		
Operate delay	0-10,000.000 sec	The time delay before operation when the operate conditions are fulfilled
Release delay	0-10,000.000 sec	The time delay before release when the release conditions are fulfilled

The logical controller provides very fast response to events. The scan time for all setpoints is 1/2 cycle time (8 ms at 60Hz and 10 ms at 50 Hz).

Setpoints #1 is factory preset to provide standard periodic data logs on a 15-minute time basis. It is linked to the device clock and runs Data logs #1 and #2 at 15-minute boundaries of an hour.

Using Logical Expressions

Logical operators OR/AND are treated in a simplified manner. They have no specific priority or precedence rules.

Any trigger condition bound to the logical expression by the OR operator and evaluated as “true” overrides any preceding condition evaluated as “false”. Similarly, any trigger condition evaluated as “false” and bound by the AND operator overrides any condition evaluated before it as “true”.

To avoid confusion, it is recommended not to alternate different logical operators in one expression. Instead, bring all conditions that use the same logical operator together at one side of the expression, and the others - at the opposite side.

To explicitly override all other conditions with the critical trigger, put it at the end of the expression using the OR operator if you want the setpoints to be operated anyway when the trigger condition is asserted, and with the AND operator, if the setpoints should not be operated while the critical trigger is not asserted.

Using Numeric Triggers

For numeric (analog) triggers, a setpoints allows you to specify two thresholds for each trigger to provide hysteresis (dead band) for setpoints operations. The Operate Limit defines the operating threshold, and the second Release Limit defines the release threshold for the trigger. The trigger thresholds are always specified in primary units.

If you use relational operators as " \leq " (under or equal) or " \geq " (over or equal), always specify a correct Release Limit for the trigger. If you do not want to use hysteresis, set the Release Limit to the same as the Operate Limit.

With the "Delta" operator, the setpoints is operated when the absolute value of the difference between the last reported value and the current value exceeds the specified threshold

Using Binary Triggers

Binary (digital) triggers, as digital inputs, relays, or internal static and pulsed events, are tested for ON (closed/set) or OFF (open/cleared) status. Min/Max log parameters can be tested for a NEW event that is asserted when a new minimum or maximum value is recorded for the parameter since the last time it was checked.

The binary events are divided into two types: static events and pulsed events. Static events are level-sensitive events. A static event is asserted all the time while the corresponding condition exists. Examples are digital inputs, relays and internal static events generated by the device diagnostics, metering procedures, and Power Quality and Fault recorders.

Pulsed events are edge-sensitive events with auto-reset. A pulsed event is generated for a trigger only once when a positive transition edge is detected on the trigger input. The examples of pulsed events are pulse inputs (transition pulses on the digital inputs), internal pulsed events (energy pulses and time interval pulses), and events generated by the interval timers. The logical controller automatically clears pulsed events at the end of each scan, so that triggers that used pulsed events are prevented from being triggered by the same event once again.

Using Event Flags and Virtual Relays

The PM180 has 16 common binary flags, called event flags, which can be individually set, cleared and tested through setpoints or remotely.

Event flags can be used in different applications, for example, to transfer events between setpoints in order to expand a logical expression or a list of actions that have to be done for a specific event, or to remotely trigger setpoints actions from the SCADA system or from a PLC.

In the same way, any of the 32 device relays that is not actually present in your device (it is called a virtual relay) can be used to transfer events from one setpoints to others, or to indicate events to the setpoints from the external system.

Using Interval Timers

The PM180 has 16 interval timers that are commonly used for periodic recording of interval data at the time of the fault or in the presence of other events detected by setpoints. Some of the timers are factory preset for use with the Power Quality and Fault recorders, and others can be programmed to generate periodic events at user-defined intervals (see [Using Periodic Timers](#)).

Interval timers are not synchronized with the clock. When you run a timer, it generates a pulsed timer event that can trigger a setpoints if you have put the timer into a list of the setpoints triggers. When the setpoints event is asserted, the timer is restarted, and then generates the next timer event when the timer interval expires.

If you want to record interval data at predefined intervals without linking to other events, just select a timer as a setpoints trigger and specify in the setpoints actions list a data log file you want to use for recording. If you want the periodic data to be recorded in presence of a specific event, select triggers that identify your event, and then add the timer at the end of the trigger list using the AND operator.

Using Time Triggers

If you want the setpoints actions to be synchronized with the clock, for example, to provide synchronous recording interval data each 15 minutes or each hour, or to output time pulses through relay contacts, use the time triggers that generate static events synchronized to the device clock.

You can exercise the default setting for Setpoints #1 in your device as an example of using time triggers. The setpoints is pre-programmed for data profiling at 15-minute intervals using data logs #1 and #2.

Using the Voltage Disturbance Trigger

The voltage disturbance trigger (found under the VOLT DISTURB name in the SPECIAL INPUTS trigger group) detects all types of the voltage waveshape faults on any phase caused by fast transient voltages. You can use it to record disturbances if you want to do this differently from the way the Power Quality recorder does it.

The operate threshold for the voltage disturbance trigger defines the maximum allowable voltage deviation from a steady-state level above which the device declares a waveshape fault. It is specified as a percent of the nominal voltage. Using PAS you may select volts units or % of nominal voltage from the "Preferences" tab in the "Tools/Options dialog (see [Voltage Disturbance Units](#) in Chapter 13).

The trigger does not respond to slow voltage variations whenever the voltage rise above or drop below the specified threshold takes longer than 1 cycle time.

Delaying Setpoints Operations

Two optional delays can be added to each setpoints to extend monitoring setpoints triggers for a longer time before making a decision on whether the expected event occurred or not. When a delay is specified, the logical controller changes the setpoints status only if all conditions are asserted for a period at least as long as the delay time.

Although a delay can be specified with a 1-ms resolution, the actual value is aligned at a lower 1/2-cycle time boundary.

Note that you cannot use delays with pulsed events since they are cleared immediately and do not longer exist on the next setpoints scan.

Using Setpoints Events and Actions

When a setpoints status changes, i.e., a setpoints event is either asserted or de-asserted, the following happens in your device:

1. The new setpoints status is logged to the setpoints status register that can be monitored from the SCADA system or from a programmable controller in order to give an indication on the expected event.
2. The operated setpoints status is latched to the setpoints alarm latch register, which is remotely accessible. The register holds the last setpoints alarm status until it is explicitly cleared.
3. Up to four programmable actions can be performed in sequence on setpoints status transition when a setpoints event is asserted.

Generally, setpoints actions are performed independently for each setpoints and can be repeated a number of times for the same target. The exceptions are relay operations, data logging and waveform logging that are shared between all setpoints using an OR scheme for each separate target.

A relay output is operated when one of the setpoints linked to the relay is activated and stays in the operated state until all of these setpoints are released (except for latched relays that require a separate release command to be deactivated).

Data logging and waveform logging directed to the same file are done once for the first setpoints among those that specify the same action, guaranteeing that there will not be repeated records related to the same time.

Recording Setpoints Events

Time-tagged setpoints events can be recorded both to the Event log, and to the Sequence-of-Events log files if you put corresponding actions into the setpoints action list.

If you link a setpoints to the Sequence-of-Events recorder, all setpoints transition events are recorded to the Sequence-of-Events log by default. If you select to record setpoints operations into the Event log, define in the action target box which transition events you want to be recorded: when

the setpoints is operated, when it is released, or both events. The Event recorder puts into a log file a separate record for each active trigger caused a setpoints status transition, and a separate record for each action done on the setpoints activation (except for logging actions that are not recorded to the Event log).

If you run a number of recorders from the same setpoints action list, it is recommended that you put the Event log action before others in order to allow other recorders to use the event sequence number given to the event by the Event recorder.

Cross Triggering Setpoints

When a setpoints is operated, the device sends a broadcast UDP message across the network using one of the sixteen triggering channels. All devices that have a setpoints programmed to respond to this trigger act in response. The cross triggering delay is normally less than one cycle time.

To send a cross triggering message, put an “EXT TRIGGER” action into the setpoints actions list and select one of the sixteen triggering channels as a target. In all devices, which you want to respond to this message, select an “EXT TRIGGER” group in the setpoints triggers list and specify the channel through which the device would receive messages.

Configuring the PMU IEC 61850 SV publisher

The PMU SV publisher options and the sampled values dataset can be configured via PAS IEC 61850 dialogs as shown in the following pictures.

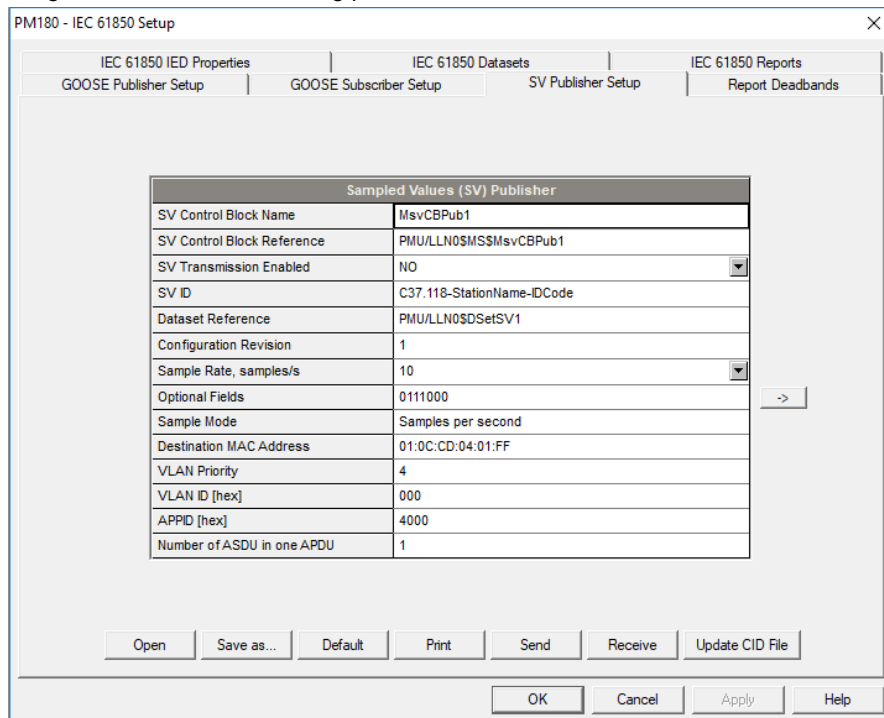

Figure 6-1 SV Publisher configuration tab

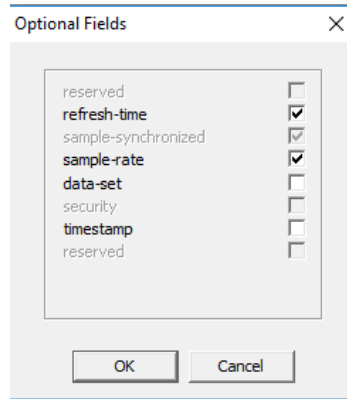

Figure 6-2 Optional fields configuration

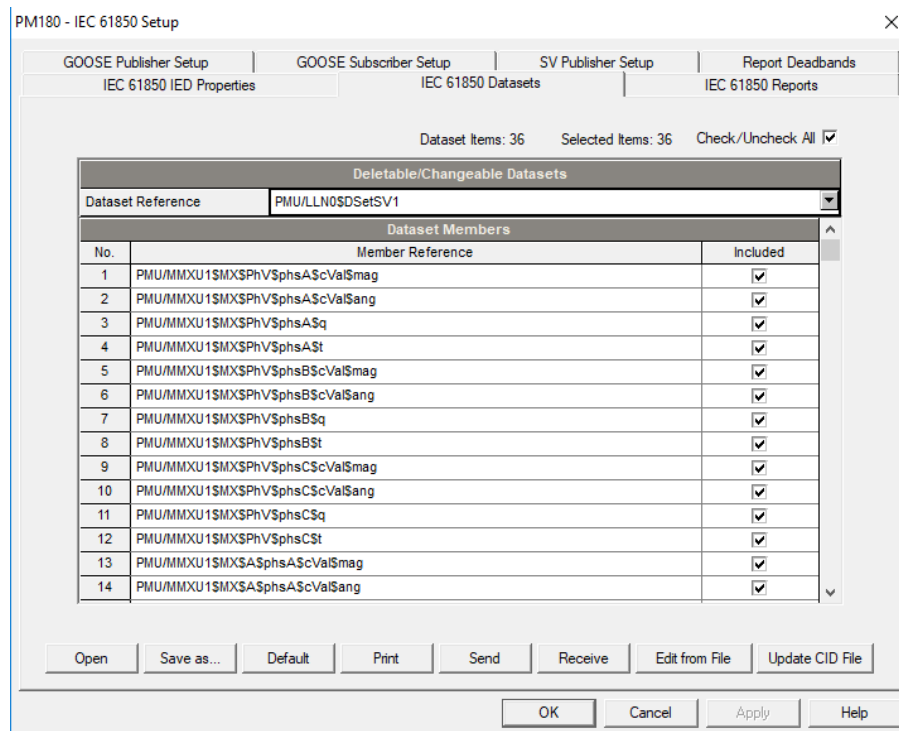

Figure 6-3 SV Dataset configuration tab

Configuring IEEE C37.118.2

Use PAS configuration software provided with your device to configure IEEE C37.118.2 options. See the PM180 Operation Manual for more information on installation and operating PAS on your computer.

The PM180 firmware version must be at least V31.XX.31

To configure the IEEE C37.118.2 options:

1. Ensure that the selected connection protocol to communicate with your device is set to Modbus RTU or Modbus ASCII.
2. Select Communications Setup from the Meter Setup menu and then click on the IEEE C37.118.2 Setup tab.

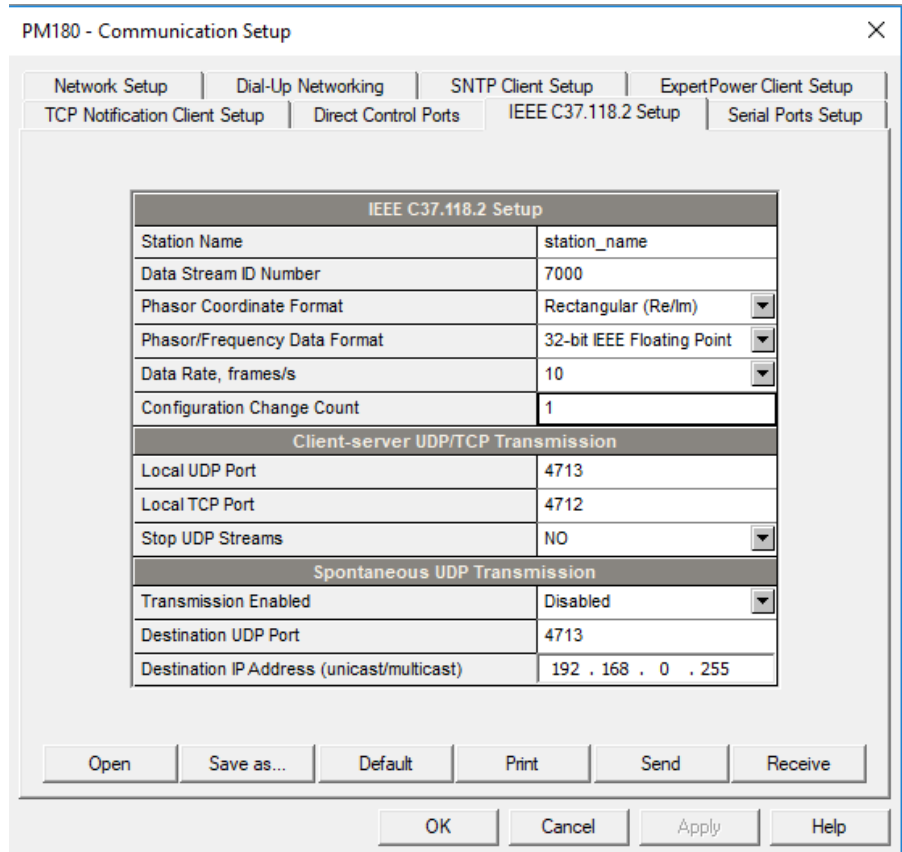

3. Select desired options.
4. Click Save as... to store your setup in the device site database, and click Send to send the setup to the device.

See the following table for available options.

Parameter	Options	Default	Description
IEEE C37.118.2 Setup			
Station Name	Up to 16 ASCII characters	station_name	Identifies the station
Data Stream ID Number	1-65534	7000	Identifies the data stream
Phasor Coordinate Format	Rectangular = phasor real and imaginary, Polar = magnitude and angle	Rectangular	Selects the representation format for phasor vector
Phasor/Frequency Data Format	16-bit integer, 32-bit IEEE floating point	32-bit IEEE floating point	Selects the data format for phasor and frequency data
Data Rate, frames/s	1, 2, 3, 4, 5, 6, 10, 12, 15, 20, 25, 30, 50, 60	10	Rate of data transmission.
Configuration Change Count	0-65535	0	

Parameter	Options	Default	Description
Client-server UDP/TCP Transmission			
Local UDP Port	1024-49151	4713	Local UDP port number for commanded client-server UDP operation.
Local TCP Port	1024-49151	4712	Local TCP port number for client-server TCP operation.
Stop UDP Streams	NO, YES	NO	Stops all active commanded UDP streams. Can be used to stop uncontrollable UDP streams in case of an abnormal client disconnection.
Spontaneous UDP Transmission			
Transmission Enabled	Disabled, Enabled	Disabled	Enables spontaneous data transmission.
Destination UDP Port	1024-49151	4713	Destination port number for spontaneous data transmission.
Destination IP Address (unicast/multicast)		192.168.0.255	Destination IP address for spontaneous data transmission. Can be unicast, multicast or broadcast address.

NOTES:

1. Configure the Synchrophasor data frame properties and local port settings before turning on the data transmission. Changing either invalidates all active data streams and stops data transmission in progress.
2. Changing the local TCP port causes closing all active connections and restarting the network services. If you make changes via an Internet connection, wait a couple of seconds until the network is ready for operation before sending a new connection request.
3. The selected data rate is automatically rounded up to the nearest sub-multiple of the nominal frequency. In case of using both IEEE C37.118.2 and IEC 61850 Synchrophasor data communications, the new data rate is applied to both protocols.
4. Changing the Synchrophasor data frame properties advances the configuration change count. You can set it to any desired number by explicit writing the count value.

Chapter 7 Configuring Recorders

The PM180 is provided with a 256MB onboard non-volatile memory for data, event and waveform recording.

Before using recorders, the device memory must be partitioned between log files. The device memory is fully configurable; you can define how much memory to allocate for each log file. If you want to change the factory settings, follow the guidelines in the section below.

Configuring Device Memory

The PM180 memory can be partitioned for a total of 28 log files:

- Event log
- 16 Data logs
- 8 Waveform logs
- SOE log
- IEEE 1159 or EN 50160 or GOST 32144 PQ log
- Fault log

To view the device memory settings, select Memory/Log from the Meter Setup menu, and then click on the Log Memory tab.

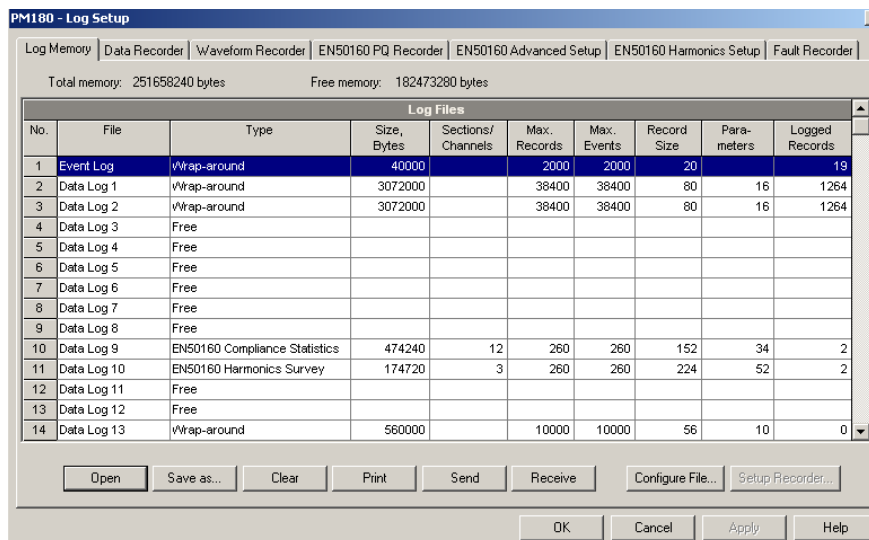

The following table shows available file options.

Option	Format/Range	Description
Type	Wrap around, Non-wrap TOU Monthly Profile TOU Daily Profile	Defines the file behavior when it is filled up. Wrap around: recording continues over the oldest records. Non-wrap: recording is stopped until the file is cleared. TOU Monthly Profile: monthly TOU profile data log (only for data log #15). Wrap around by default. TOU Daily Profile: daily TOU profile data log (only for data log #16). Wrap around by default.
Size		Shows the size of the memory allocated to the file. It is set automatically depending on the size of a file record and the number of records in the file.
Sections/Channels	0-32	Defines the numbers of sections in a multi-section TOU profile data log file or the number of recording channels in a waveform log file
Num. of Records	0-65535	Allocates the file memory for a predefined number of records
Record size		Shows the size of the file record for a single channel or section. It is set automatically depending on the file and on the number of parameters in the data record

Option	Format/Range	Description
Parameters		Defines the number of parameters in a single data record for data log files.

Memory is allocated for each file statically and does not change unless you re-organize the files. The PM180 automatically performs de-fragmentation of the memory each time the file allocation changes. This helps keep all free memory in one continuous block, and thus prevents possible leakage of memory caused by fragmentation.

In the EN 50160 version, data log files #9 and #10 are automatically configured for recording EN 51060 compliance statistics and harmonics survey data. You may not change the record structure, but can change the amount of memory allocated for each file.

Data log files #15 and #16 may be configured to record TOU monthly profile and TOU daily profile data on a daily or monthly basis.

To change the file properties or to create a new file:

1. Double click on the file partition you want to change, or highlight the file row, and then click on the "Configure File" button.
2. To change the file properties, select desired parameters, and then click OK. For your reference, the record size and the number of records available for the file are reported in the dialog box.
3. To delete a file partition, click on Delete, and then click OK.
4. Send your new setup to the device.

The following table shows how to calculate a file size for different files.

File	Record Size, Bytes	File Size, Bytes
Event Log	20	Record Size × Number of Records
Data Log	12 + 4 × Number of Parameters	Record Size × Number of Records
EN50160 Compliance Statistics (Data log #9)	152 (per channel) × 12	Record size × Number of records
EN50160 Harmonics Survey (Data log #10)	224 (per channel) × 3	Record size × Number of records
TOU Profile Log (Data log #15-#16)	12 + 4 × Number of Season Tariffs	Record Size × Number of TOU Registers × Number of Records × 2
Waveform Log	1072	Record Size × Number of Channels × Number of Series × Number of Records per Series
SOE Log	16	Record Size × Number of Records
PQ Log	32	Record Size × Number of Records
Fault Log	44	Record Size × Number of Records

For more information on configuring specific files, see following sections.

The device memory is pre-configured for regular data trending and fault recording applications as shown in the following table.

No.	File	Type	Size, Bytes	Sections/Channel	Max. of Records	Max. of Events	Description
-----	------	------	-------------	------------------	-----------------	----------------	-------------

No.	File	Type	Size, Bytes	Sections/Channel	Max. of Records	Max. of Events	Description
1	Event log	Wrap around	40000		2000	2000	
2	Data log #1	Wrap around	3072000		38400	38400	Configured for continuous data recording
3	Data log #2	Wrap around	3072000		38400	38400	Configured for continuous data recording
10	Data log #9	Wrap around	474240	12	260	260	Configured for EN50160 compliance statistics
11	Data log #10	Wrap around	174720	3	260	260	Configured for EN50160 harmonics survey
12	Data log #11	Wrap around	51287040	14	8640	8640	IEC 61000-4-30 PQ profile ¹
14	Data log #13 (fault data trend)	Wrap around	560000		10000	10000	Used by the Fault recorder
15	Data log #14 (PQ data trend)	Wrap around	520000		10000	10000	Used by the PQ recorder
24	Waveform log #7	Wrap around	42880000	10	4000	1000	Used by the PQ and Fault recorders
25	Waveform log #8	Wrap around	17152000	8	2000	500	Used by the PQ recorder
26	SOE log	Wrap around	160000		10000	10000	
27	PQ log	Wrap around	640000		20000	20000	
28	Fault log	Wrap around	440000		10000	10000	

Configuring the Event Recorder

To change the Event log file size:

1. Select Memory/Log from the Meter Setup menu, and then click on the Log Memory tab.
2. Double click on the Event log file partition with the left mouse button.

¹ New predefined data log #11 – 10mn aggregation time interval PQ profile from firmware version V31.XX.30

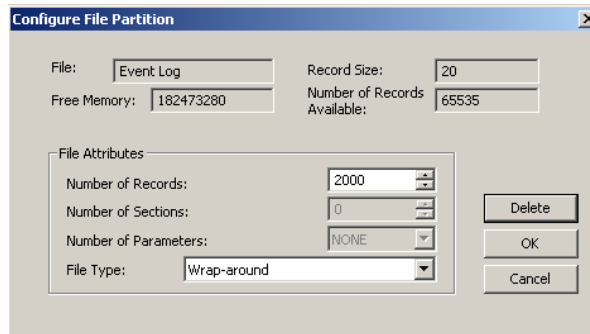

3. Select a file type.
4. Select the maximum number of records you want to be recorded in the file.
5. Click OK, and then send your new setup to the device or save to the device database.

By default, the Event recorder stores all events related to configuration changes, reset, and device diagnostics. In addition, it records events related to setpoints operations. Each setpoints should be individually enabled for recording to the Event log.

To log setpoints operations, add the “Event log” action to the setpoints actions list. Put the event log action at the beginning of the list to allow other recorders to use the sequence number assigned to the event for cross-linking between records logged to different files. When a setpoints event happens, the Event recorder logs all setpoints conditions that caused the event and all setpoints actions performed in response to the event.

Configuring the Sequence-of-Events Recorder

The Sequence-of-Events (SOE) recorder can log four types of events:

- Digital input events
- Relay output events
- Fault events
- Setpoints events

Each state transition on a source point (open/closed, start/end) is recorded as a separate event. Fault events are recorded to the file by default. Others should be individually enabled to be recorded to the SOE log.

To change the SOE log file size:

1. Select Memory/Log from the Meter Setup menu, and then click on the Log Memory tab.
2. Double click on the SOE log file partition with the left mouse button.

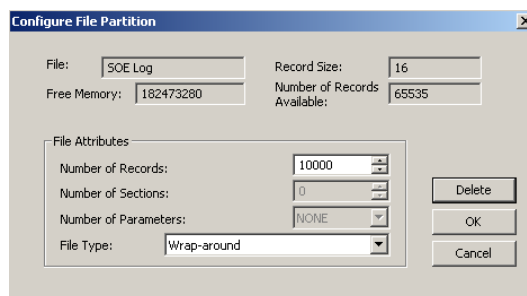

3. Select a file type.
4. Select the maximum number of records you want to be recorded in the file.
5. Click OK, and then send your new setup to the device or save to the device database.

Linking Digital Inputs to the SOE Log

To link a digital input to the SOE log, check the “SOE Log” box when configuring the digital input (see [Configuring Digital Inputs](#)). If you linked a digital input to the Fault recorder, it is automatically connected to the SOE log even if you leaved the “SOE Log” box unchecked.

Linking Relay Outputs to the SOE Log

To link a relay output to the SOE log, check the “SOE Log” box when configuring the relay output (see [Programming Relay Outputs](#)).

Linking Setpoints to the SOE Log

To link a setpoints to the SOE log, add the “SOE Log” action to the setpoints actions list when configuring the setpoints (see [Using Control Setpoints](#)).

Adding Point and Status Labels to the SOE Log

When displaying the SOE log report, PAS shows you default designations of the event source points and their status (open/closed or start/end). You can specify your own IDs and status labels for each event point and give the point status an appropriate description, for example, define the location of the breaker or protection relay.

To define labels for your SOE event points:

1. Select Labels from the Meter Setup menu, and then click on the appropriate tab.
2. Type in the labels and descriptions you want to give the event source points and their status.
3. Select appropriate label colors.
4. Click on “Save as” to save your settings to the site database.
5. Send your setup to the device so you can recall your labels when connecting to the device from another PC.

An ID or status label can be up to 32 characters long, and a status description can have up to 96 characters. The text boxes have a scroll option to accommodate more characters than can be viewed in the box. If your label or description is too long to fit in a box, the text scrolls to allow you to enter long strings.

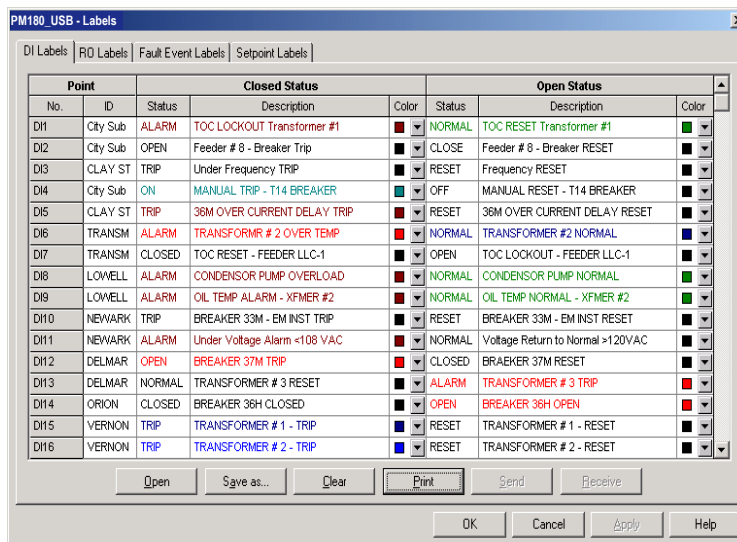

Configuring the Data Recorder

The Data recorder is programmable to record up to 16 data parameters per record in each of 16 data log files. The list of parameters to be recorded to a data log is configured individually for each file.

Conventional Data Log Files

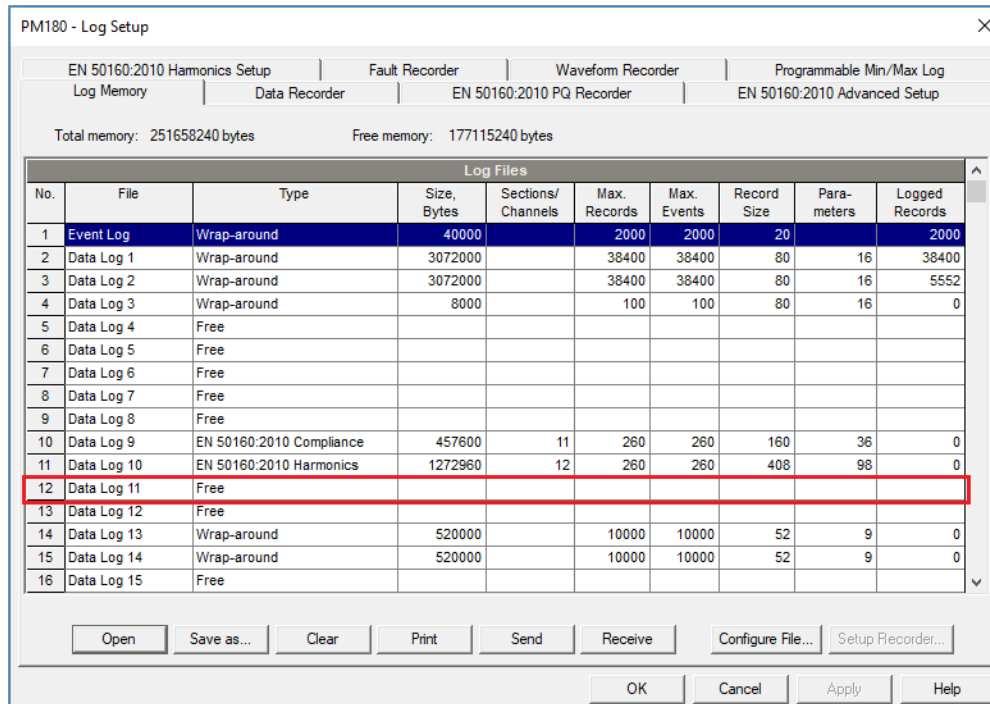

To create a new data log file or re-configure an existing file:

1. Select Memory/Log from the Meter Setup menu, and then click on the Log Memory tab.
2. Double click on the file partition with the left mouse button.
3. Select a file type.
4. Select the number of parameters to be recorded in the file records.
5. Select the maximum number of records to be recorded in the file.
6. Click OK, and then send your new setup to the device, or save to the device database.

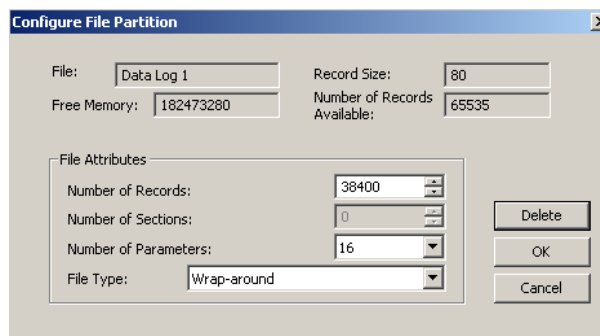

7. Highlight the data log file row with the left mouse button, and then click on the "Setup Recorder" button, or click on the "Data Recorder" tab and select the log number corresponding to your file.

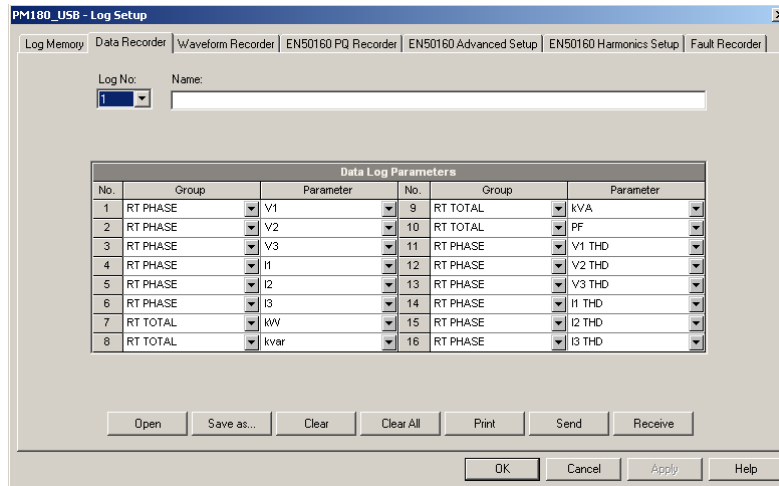

- Configure the list of parameters to be recorded in the data log file. You are not allowed to select more parameters than you defined when configuring your file. Refer to Appendix C for a list of available parameters.

For your convenience, PAS follows your selection and helps you to configure a series of the neighboring parameters: when you open the “Group” box for the next parameter, PAS highlights the same group as in your previous selection; if you select this group again, PAS automatically updates the “Parameter” box with the following parameter in the group.

- Add the name for your data log file in the “Name” box. It will appear in the data log reports.
- Save your new setup to the device database, and send it to the device.

Factory Preset Periodic Data Logs

Data logs #1 and #2 are factory preset for periodic recording of the standard power quantities as shown in the following table.

No.	Parameter	No.	Parameter
Data Log #1			
1	RT (1-cycle) V1	9	RT (1-cycle) Total kVA
2	RT (1-cycle) V2	10	RT (1-cycle) Total PF
3	RT (1-cycle) V3	11	RT (1-cycle) V1 THD
4	RT (1-cycle) I1	12	RT (1-cycle) V2 THD
5	RT (1-cycle) I2	13	RT (1-cycle) V3 THD
6	RT (1-cycle) I3	14	RT (1-cycle) I1 THD
7	RT (1-cycle) Total kW	15	RT (1-cycle) I2 THD
8	RT (1-cycle) Total kvar	16	RT (1-cycle) I3 THD
Data Log #2			
1	kW Import Sliding Demand	9	I1 Demand
2	kvar Import Sliding Demand	10	I2 Demand
3	KVA Sliding Demand	11	I3 Demand
4	kWh Import	12	V1 Demand
5	kWh Export	13	V2 Demand
6	kvarh Import	14	V3 Demand
7	kvarh Export	15	RT (1-cycle) I4
8	kVAh	16	RT (1-cycle) V4

Setpoints #1 is preset at the factory to trigger Data logs #1 and #2 in 15 min intervals.

IEC 61000-4-30 Profile Data log

Data log #11 is factory preset for 10minutes average, minimum and maximum basic parameters and power quality parameters measurements recorder, a total of 1345 parameters per records. It consists of a sectional log file divided in 14 portions with approximately 100 parameters for each section; table below shows the list of parameters for each section.

Section	Item No.	Parameter Name	No. of Params	Types of Params			Comments
0		IEC 61000-4-30 - RMS-Power Profile					
	1-3	RMS voltage A	3	MEAN	MAX	MIN	In RMS Volts
	4-6	RMS voltage B	3	MEAN	MAX	MIN	In RMS Volts
	7-9	RMS voltage C	3	MEAN	MAX	MIN	In RMS Volts
	10-12	RMS voltage N	3	MEAN	MAX	MIN	In RMS Volts
	13-15	RMS voltage AB	3	MEAN	MAX	MIN	In RMS Volts
	16-18	RMS voltage BC	3	MEAN	MAX	MIN	In RMS Volts
	19-21	RMS voltage CA	3	MEAN	MAX	MIN	In RMS Volts
	22-24	Frequency	3	MEAN	MAX	MIN	In Hertz
	25-27	RMS Current A	3	MEAN	MAX	MIN	In RMS Amps
	28-30	RMS Current B	3	MEAN	MAX	MIN	In RMS Amps
	31-33	RMS Current C	3	MEAN	MAX	MIN	In RMS Amps
	34-36	RMS Current N	3	MEAN	MAX	MIN	In RMS Amps
	37-39	Active Power A	3	MEAN	MAX	MIN	Net Power (+ for import and - for export)
	40-42	Active Power B	3	MEAN	MAX	MIN	
	43-45	Active Power C	3	MEAN	MAX	MIN	
	46-48	Active Power Total	3	MEAN	MAX	MIN	
	49-51	Reactive Power A	3	MEAN	MAX	MIN	
	52-54	Reactive Power B	3	MEAN	MAX	MIN	
	55-57	Reactive Power C	3	MEAN	MAX	MIN	
	58-60	Reactive Power Total	3	MEAN	MAX	MIN	
	61-63	Apparent Power A	3	MEAN	MAX	MIN	
	64-66	Apparent Power B	3	MEAN	MAX	MIN	
	67-69	Apparent Power C	3	MEAN	MAX	MIN	Calculated from Net
	70-72	Apparent Power Total	3	MEAN	MAX	MIN	
	73-75	True Power Factor A	3	MEAN	MAX	MIN	Calculated from Net
	76-78	True Power Factor B	3	MEAN	MAX	MIN	
	79-81	True Power Factor C	3	MEAN	MAX	MIN	
	82-84	Displacement Power Factor A	3	MEAN	MAX	MIN	Calculated from Net
	85-87	Displacement Power Factor B	3	MEAN	MAX	MIN	
	88-90	Displacement Power Factor C	3	MEAN	MAX	MIN	
	91	Watthours A	1				Net Power (+ for import and - for export)
	92	Watthours B	1				
	93	Watthours C	1				
	94	Watthours Total	1				
	95	Varhours A	1				
	96	Varhours B	1				
	97	Varhours C	1				
	98	Varhours Total	1				
	99	VA hours A	1				
	100	VA hours B	1				
	101	VA hours C	1				
	102	VA hours Total	1				
1		IEC 61000-4-30 - PQ Profile					
	1-2	V Unbalance (S2/S1) Total	2	MEAN	MAX		
	3-4	I Unbalance (S2/S1) Total	2	MEAN	MAX		
	5-6	Transformer K Factor A	2	MEAN	MAX		
	7-8	Transformer K Factor B	2	MEAN	MAX		
	9-10	Transformer K Factor C	2	MEAN	MAX		

	11	Short Term Flicker A	1				
	12	Short Term Flicker B	1				
	13	Short Term Flicker C	1				
	14	Long Term Flicker A	1				
	15	Long Term Flicker B	1				
	16	Long Term Flicker C	1				
	17-18	Voltage TID A	2	MEAN	MAX		
	19-20	Voltage TID B	2	MEAN	MAX		
	21-22	Voltage TID C	2	MEAN	MAX		
	23-24	Current TID A	2	MEAN	MAX		
	25-26	Current TID B	2	MEAN	MAX		
	27-28	Current TID C	2	MEAN	MAX		
	29-31	Current TDD A	3	MEAN	MAX	MIN	
	32-34	Current TDD B	3	MEAN	MAX	MIN	
	35-37	Current TDD C	3	MEAN	MAX	MIN	
	38-39	Voltage THD A	2	MEAN	MAX		
	40-41	Voltage THD B	2	MEAN	MAX		
	42-43	Voltage THD C	2	MEAN	MAX		
	44-45	Even THD Voltage A	2	MEAN	MAX		
	46-47	Even THD Voltage B	2	MEAN	MAX		
	48-48	Even THD Voltage C	2	MEAN	MAX		
	50-51	Odd THD Voltage A	2	MEAN	MAX		
	52-53	Odd THD Voltage B	2	MEAN	MAX		
	54-55	Odd THD Voltage C	2	MEAN	MAX		
	56-57	Current THD A	2	MEAN	MAX		
	58-59	Current THD B	2	MEAN	MAX		
	60-61	Current THD C	2	MEAN	MAX		
	62-63	Even THD Current A	2	MEAN	MAX		
	64-65	Even THD Current B	2	MEAN	MAX		
	66-67	Even THD Current C	2	MEAN	MAX		
	68-69	Odd THD Current A	2	MEAN	MAX		
	70-71	Odd THD Current B	2	MEAN	MAX		
	72-73	Odd THD Current C	2	MEAN	MAX		
2	1-100	IEC 61000-4-30 - Harmonic Voltage A	100	MEAN	MAX		In RMS Volts
3	1-100	IEC 61000-4-30 - Harmonic Voltage B	100	MEAN	MAX		In RMS Volts
4	1-100	IEC 61000-4-30 - Harmonic Voltage C	100	MEAN	MAX		In RMS Volts
5	1-100	IEC 61000-4-30 - Interharmonic Voltage A	100	MEAN	MAX		In RMS Volts
6	1-100	IEC 61000-4-30 - Interharmonic Voltage B	100	MEAN	MAX		In RMS Volts
7	1-100	IEC 61000-4-30 - Interharmonic Voltage C	100	MEAN	MAX		In RMS Volts
8	1-100	IEC 61000-4-30 - Harmonic Current A	100	MEAN	MAX		In RMS Amps
9	1-100	IEC 61000-4-30 - Harmonic Current B	100	MEAN	MAX		In RMS Amps
10	1-100	IEC 61000-4-30 - Harmonic Current C	100	MEAN	MAX		In RMS Amps
11	1-100	IEC 61000-4-30 - Interharmonic Current A	100	MEAN	MAX		In RMS Amps
12	1-100	IEC 61000-4-30 - Interharmonic Current B	100	MEAN	MAX		In RMS Amps
13	1-100	IEC 61000-4-30 - Interharmonic Current C	100	MEAN	MAX		In RMS Amps

Data log #11 is preset as conventional data log as default, to configure it see [conventional data log](#), to define it as IEC 61000-4-30 Profile log:

1. Select General Setup from the Meter Setup menu, and then click on the Device Options tab.

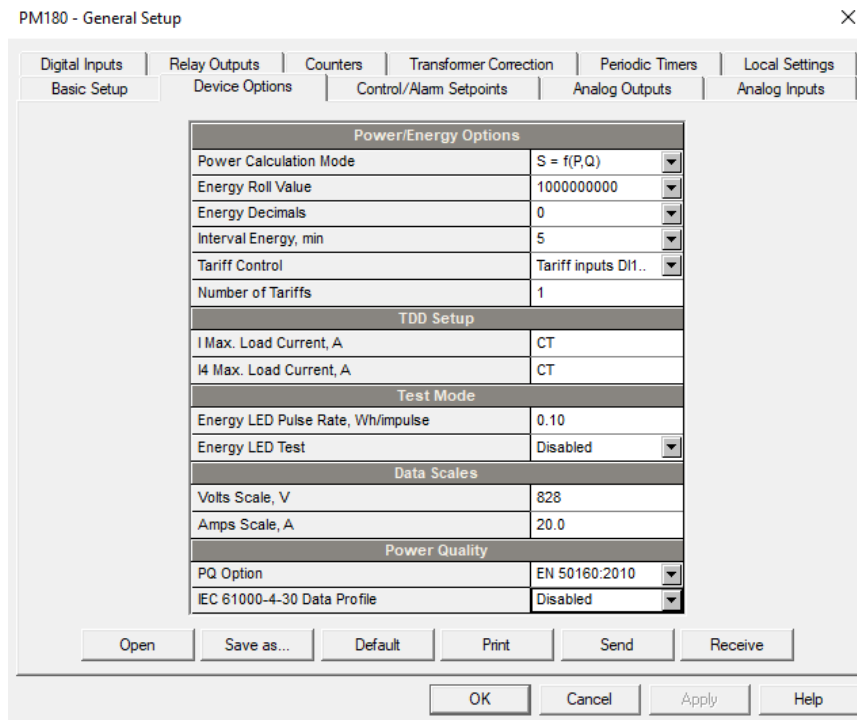

2. Select "PQ Option": EN 50160:2010.
3. Click "IEC 61000-4-30 Data Profile": Enable.
4. Click OK, and then send your new setup to the device, or save to the device database.

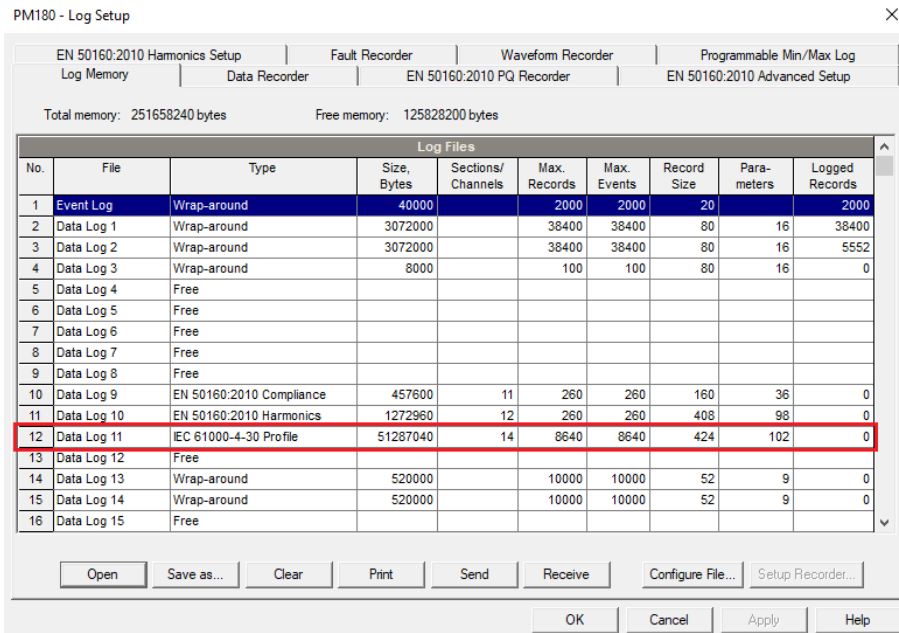

Factory Preset Fault and PQ Data Logs

Data logs #13 and #14 are factory preset for RMS trending on the fault and power quality events and are intended for the use with the Fault and PQ recorders. The default PQ and Fault data log configuration is shown in the following table.

No.	Parameter	No.	Parameter
Data Log #13 (fault data trend)			
1	Generic V1	9	Generic V ZERO-SEQ
2	Generic V2	10	Generic VDC
3	Generic V3		
4	Generic V4		
5	Generic I1x		
6	Generic I2x		
7	Generic I3x		
8	Generic I4x		
Data Log #14 (PQ data trend)			
1	Generic V1	9	Generic FREQ
2	Generic V2		
3	Generic V3		
4	Generic V4		
5	Generic I1x		
6	Generic I2x		
7	Generic I3x		
8	Generic I4x		

The generic data group represents generic volts, amps, etc., regardless of the data integration time. The PQ recorder can use different time envelopes to record data integrated over intervals from a half cycle to 10 minutes depending on the duration of the power quality event (see [Configuring the Power Quality Recorder](#)). The Fault recorder uses only the half-cycle RMS trend.

TOU Profile Data Log Files

Data log files #15 and #16 are configurable to store the TOU monthly profile log and the TOU daily profile log respectively.

A TOU profile log file is organized as a multi-section file that has a separate section for each TOU energy and maximum demand register. The number of sections is taken automatically from the Summary/TOU Registers setup (see [Configuring Summary and TOU Registers](#) in Chapter 8). Since each TOU energy register has a shadow maximum demand register, the number of sections in the file is twice the number of the allocated TOU registers.

In order to correctly allocate the memory space for TOU profile log files, assign TOU registers before you set up your TOU profile log files.

To configure a TOU daily profile log file:

1. Configure your TOU registers and TOU schedule before allocating memory for a profile log file (see [Configuring Summary and TOU Registers](#) in Chapter 8).
2. Select Memory/Log from the Meter Setup menu, and then click on the Log Memory tab.
3. Double click on the Data Log #15 or Data Log #16 partition row.

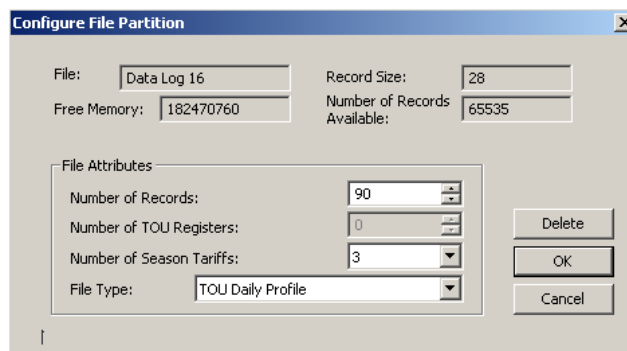

4. Select the TOU Monthly Profile or TOU Daily Profile in the File Type box.
5. Select the number of season tariffs in your TOU schedule.

6. Select the maximum number of records you want to be recorded in the file assuming that a new record is added once a month or once a day.
7. Click OK and send your setup to the device or save to the database.

Configuring the Waveform Recorder

Waveform log files are organized as multi-section files that store data for each recording channel in a separate section.

A regular waveform log file records up to 12 analog channels simultaneously: eight AC channels (four voltages and four currents), one VDC channel, and up to 48 digital inputs DI1-DI16, DI17-DI32 and DI33-DI48 organized in three sections as three 16-bit analog channels.

A single channel waveform record contains 512 points of the sampled input signal. If a waveform log is configured to record more samples per event than a single record can hold, the waveform recorder stores as many records per event as required to record the entire event. All waveform records related to the event are merged in a series and have the same series number, so they can be plotted together.

The PM180 supports 8 waveform files that can record waveforms at four programmable sampling rates: 32, 64, 128 or 256 samples per cycle.

To configure a waveform log file:

1. Select Memory/Log from the Meter Setup menu, and then click on the Log Memory tab.
2. Double click on a waveform log partition with the left mouse button.
3. Select a file type for your file.
4. Select the maximum number of records to be recorded in the file.

The number of records in the waveform log file needed to store one waveform event (series) is defined as follows:

$$\text{Number of Records per Series} = \text{Sampling Rate (Samples per Cycle)} \times \text{Number of Cycles per Event} / 512$$

The total number of records you must allocate to store the required number of events (series) is defined as follows:

$$\text{Number of Records} = \text{Number of Records per Series} \times \text{Number of Series}$$

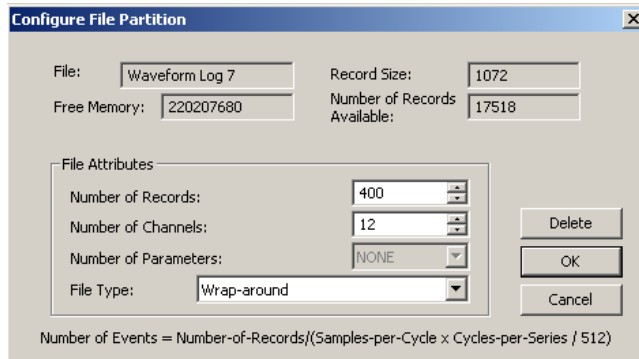

For example, if you want to record a 64-cycle waveform sampled at a rate of 32 samples per cycle, the number of records required for one waveform series would be:

$$\text{Number of Records per Series} = (32 \times 64) / 512 = 4.$$

If you want to allocate space sufficient to store 20 waveform events (series), you should set up the waveform log file for $4 \times 20 = 80$ records.

5. Click OK, and send your setup to the device or save to the database.
6. Click "Setup Recorder", or click on the "Waveform Recorder" tab.

The following table lists available waveform options.

Option	Range	Description
Samples per Cycle	32, 64, 128, 256 samples/cycle	Defines the sampling rate for the waveform log

Option	Range	Description
Cycles per Series	16-10848 (32 samples/cycle), 8-5424 (64 samples/cycle), 4-2712 (128 samples/cycle) 2-1356 (256 samples/cycle)	Defines the total duration of the waveform recording per event/series
Before Cycles	1-20	Defines the number of cycles to be recorded prior to the event
Num. of Channels	1-26	The number of the simultaneously recorded channels

7. Select the sampling rate for waveforms.
8. Select the number of cycles to be recorded prior to the event, and a total number of cycles in the waveform.
9. Add the name for your waveform log file in the "Name" box. It will appear in the waveform reports.

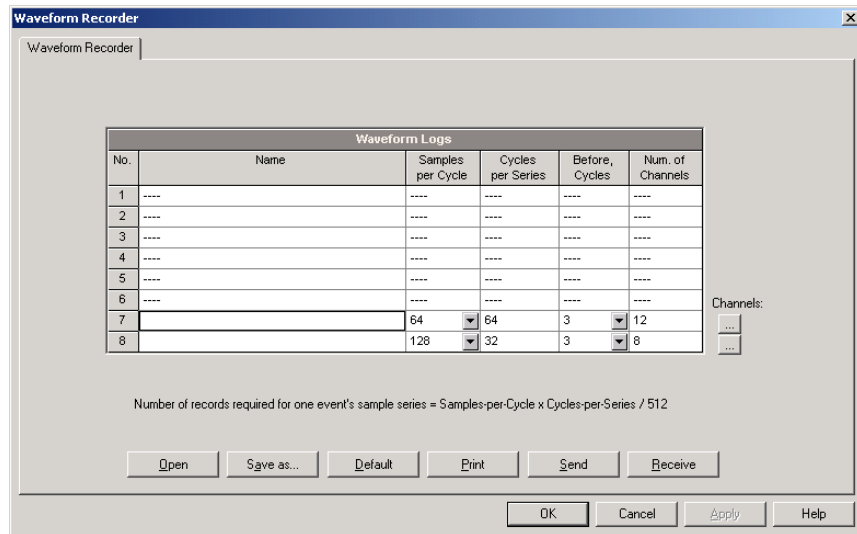

10. To select the channels, click on the "Channels" button, check the boxes for channels to be recorded, and then click OK. Note that the standard (20A) and extended (100A) current channels may not be recorded together in the same file.

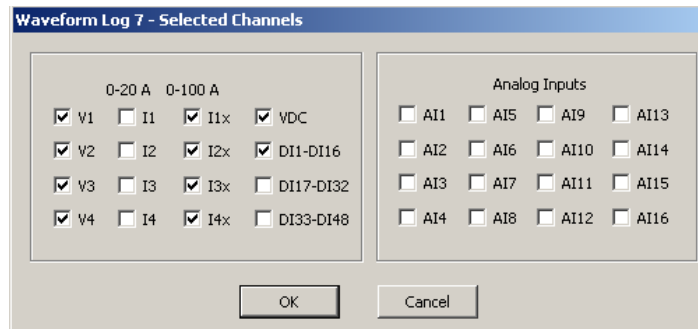

11. Save your waveform setup to the site database, and send it to the device.

The picture above shows the factory preset waveform logs. Waveform log #7 is used with the PQ and Fault recorders to store fault events, and PQ transient and short duration events. Waveform log #8 is used with the PQ recorder to store waveforms related to harmonics events.

Configuring the IEEE 1159 Power Quality Recorder

The Power Quality (PQ) recorder identifies the IEEE 1159 power quality events and records them to the log file with the precise start and end timestamps and a fault magnitude. The IEEE 1159 PQ report can be retrieved from the device, stored on a PC and displayed on the screen as shown in Section "Viewing the IEEE 1159 Power Quality Log". Impulsive transients and short-duration voltage variations (sags and swells) can also be viewed as magnitude/duration pairs on the well-known ITIC curve chart for assessing the minimum equipment immunity.

The PQ recorder can trigger the waveform recorder to record the fault waveforms before, during and after the PQ event for detailed event analysis. It may be useful for troubleshooting problems throughout electrical networks, for example, to identify and locate the source of a power quality event and to select an appropriate solution.

PQ Events Evaluation

The events are classified in accordance with the IEEE 1159 power quality categories. The table below shows the categories recorded by the device, the metering data used to detect voltage and frequency faults, their typical triggering thresholds and event durations.

Impulsive transients

Impulsive transients are detected as impulses with a rise time less than 0.5 ms and duration from 80 us to ½ cycle. The impulse magnitude is measured as the overshoot voltage magnitude above the normal voltage wave shape. It is referenced to the nominal peak voltage (1.414 Un).

Sags and swells

A voltage sag or swell is classified as one polyphase event regardless of the shape and of the number of phases affected (as per IEC 61000-4-30). An event can begin on one phase and end on another phase. The fault magnitude is recorded separately for each phase involved. The event duration is measured from the instant at which the voltage falls/rises below/above the start threshold on one of the phases to that at which it becomes greater/lower than the end threshold on all affected phases including a threshold hysteresis.

Voltage Interruptions

The voltage interruption is detected when the voltages on all phases fall below the interruption threshold (as per IEC 61000-4-30).

Flicker

The flicker is evaluated according to IEC 61000-4-15. The 10-min Pst values are used to follow and indicate the flicker faults.

Event ID	IEEE 1159 category	Trigger parameter	Reference value	Typical thresholds, %	Event duration
PQE11	Impulsive transients	Instantaneous overshoot voltage	Un peak voltage	20-200%	80 us–10 ms
PQE211	Instantaneous sag	½ cycle RMS voltage	Un RMS	80-90%	< 30 cycles
PQE212	Instantaneous swell	½ cycle RMS voltage	Un RMS	110-120%	< 30 cycles
PQE221	Momentary interruption	½ cycle RMS voltage	Un RMS	0-10%	< 3 sec
PQE222	Momentary sag	½ cycle RMS voltage	Un RMS	80-90%	< 3 sec
PQE223	Momentary swell	½ cycle RMS voltage	Un RMS	110-120%	< 3 sec
PQE231	Temporary interruption	½ cycle RMS voltage	Un RMS	0-10%	< 1 min
PQE232	Temporary sag	½ cycle RMS voltage	Un RMS	80-90%	< 1 min
PQE233	Temporary swell	½ cycle RMS voltage	Un RMS	110-120%	< 1 min
PQE31	Sustained interruption	½ cycle RMS voltage	Un RMS	0-10%	> 1 min
PQE32	Undervoltage	½ cycle RMS voltage	Un RMS	80-90%	> 1 min
PQE33	Overvoltage	½ cycle RMS voltage	Un RMS	110-120%	> 1 min
PQE4	Voltage unbalance	3-sec negative sequence unbalance	No	1-5%	Steady state
PQE52	Harmonics THD	3-sec harmonic THD	No	5-20%	Steady state
PQE53	Interharmonics THD	3-sec interharmonic THD	No	2-8%	Steady state
PQE6	Voltage fluctuations (flicker)	10-min Pst	No	1-5	Steady state
PQE7	Frequency variations	3-sec frequency	Nominal frequency	1-6%	Steady state

Un – nominal device voltage

PQ Recorder Setup

The IEEE 1159 PQ recorder setup allows you to adjust thresholds and hysteresis for PQ triggers, to define the waveform and data log options for PQ events, and to enable or disable the PQ recorder in your device.

To configure the PQ recorder:

1. Select Memory/Log from the Meter Setup menu, and then click on the PQ Recorder tab.
2. If you want to change the default settings, adjust thresholds and hysteresis for PQ triggers
3. Select the waveform and data logging options for PQ events
4. Download your setup to the device.

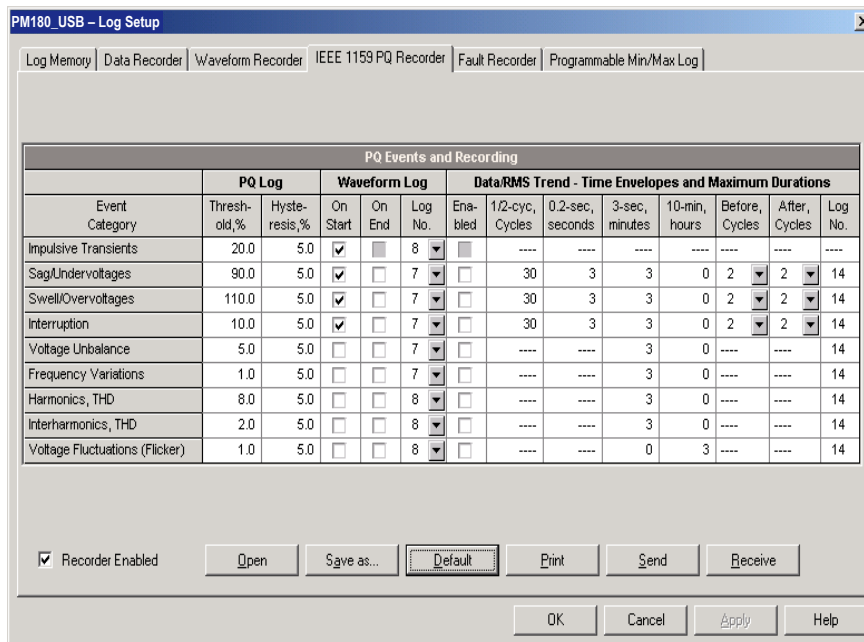

The available PQ recorder options are shown in the following table:

Option	Range	Default	Description
Thresholds			
Threshold, %	0-200.0%		Defines the operating threshold for the PQ trigger in percent of the nominal (reference) value
Hysteresis, %	0-50.0%	5.0	Defines the hysteresis for PQ trigger in percent of the threshold
Waveform Log			
On Start	Checked Unchecked	Checked	Enables waveform log when the PQ event starts
On End	Checked Unchecked	Unchecked	Enables waveform log when the PQ event ends
Log No.	1-8	7	Specifies the waveform log file used for waveform recording on the PQ event
Data/RMS Plot			
Enabled	Checked Unchecked	Unchecked	Enables concurrent RMS trace plot to the data log file while the PQ event continues
1/2-cyc	0-10,000 cycles	30	Duration of the 1/2-cycle data trace
0.2-sec	0-10,000 seconds	3	Duration of the 0.2-second data trace
3-sec	0-10,000 minutes	3	Duration of the 3-second data trace
10-min	0-10,000 hours	0	Duration of the 10-minute data trace
Before, Cycles	0-20 cycles	2	The number of cycles to be recorded prior to the event
After, Cycles	0-20 cycles	2	The number of cycles to be recorded after the event
Log No.	14		Specifies the data log file used for data recording on the PQ event

The Sag, Swell and Interruption triggers use the same waveform and data log options. If you change one of them, the others are automatically adjusted to the same setting.

The waveform log option allows recording waveforms both at the start and the end of a PQ event. Since the voltage variations may last from some seconds to minutes, this allows capturing and analyzing the voltage transitions using short time waveform recording at the start and the end of the voltage sag or swell.

The data log option allows concurrent recording of the RMS data at a variable rate depending on the PQ event duration. To reduce the memory consumption for recording long duration events, the PQ recorder uses different time envelopes (aggregation intervals) for data tracing and changes the recording rate accordingly. You can specify for each PQ trigger how much time to record data using one or more time envelopes.

To enable or disable the PQ recorder:

1. Check or uncheck the “Recorder Enabled” checkbox.
2. Send your setting to the device.

Power Quality Event Indication and Cross Triggering

When the PQ recorder detects a power quality fault, it generates the specific internal event PQ EVENT that can be monitored through a control setpoints to give a fault indication via relay contacts. The event can be found under the STATIC EVENTS group in the setpoints trigger list.

The power quality fault signal is used for cross triggering multiple recorders through a dedicated digital input in order to simultaneously record disturbances at different locations. External triggering of the Waveform and Data recorders for recording disturbance data can be done through a setpoints programmed to monitor the status of a digital input. For more information on cross triggering, see [Fault Indication and Cross Triggering](#).

Configuring the EN50160 Power Quality Recorder

EN50160 Background

The EN50160 European standard “Voltage characteristics of electricity supplied by public distribution systems” issued by CENELEC defines the main physical characteristics of electric energy supplied by low and medium voltage public distribution systems under normal operating conditions.

The voltage characteristics are evaluated using a statistical approach. The standard and its referenced publications specify for each voltage characteristic:

- Method of evaluation
- Integrating interval for a single measurement
- Observation period
- Statistical indication of the probability of not exceeding a specified limit
- Standard compliance limits or indicative values within which any customer can expect the voltage characteristics to remain

Note:

For EN51060: 2007 edition follow the manual below, for EN 50160: 2010 see PM180 EN50160-2010 PQ Recorder - Application Note - BB0180 REV.A1

Compliance Limits

For some voltage characteristics, the standard provides definite limits that can be complied with for most of the time considering the possibility of relatively rare excursions beyond these limits. Limits are set with a view to compliance for a percentage of the observation time, e.g. 95% of the observations in any period of one week.

The following table gives the characteristics for which definite limits have been specified by the standard.

Voltage characteristic	Compliance with stated limits, % of time	Observation period
Power frequency	±1% for 95% of a week ±1% for 99.5% of a year +4/-6% for 100% of time	Week, year
Voltage variations (supply voltage magnitude)	±10% Un for 95% of time	Week
Rapid voltage changes	≤4-5% Un (up to 10% Un)	Day
Flicker (fluctuations of voltage magnitude)	Plt ≤ 1 for 95% of time	Week
Voltage unbalance	≤2-3% for 95% of time	Week
Harmonic voltage	THD ≤ 8 for 95% of time	Week
Interharmonic voltage	To be defined	Week
Mains signaling voltage	Within “Meister-curve” for 99% of time	Day

Indicatives Values

For the remaining characteristics of the voltage, by their unpredictable nature, the standard gives only indicative values, which are intended to provide users with information on the expected order of magnitude.

The following table gives the characteristics for which indicative values have been specified by the standard.

Voltage Characteristic	Indicative values	Observation period
Voltage dips	Less than 1 s, 60% depth	Year
Short interruptions	70% less than 1 s	Year
Long interruptions	10 to 50% less than 3 min	Year
Temporary overvoltages	Less than 1.5 kV RMS	Year
Transient overvoltages	Less than 6 kV peak	Year

Resources

CENELEC publications:

EN 50160:2007 Voltage characteristics of electricity supplied by public distribution systems

EN 50160:2010 Voltage characteristics of electricity supplied by public distribution systems

IEC publications:

IEC 61000-4-7:2002 Electromagnetic compatibility (EMC) – Part 4-7 Testing and measurement techniques – General guide on harmonics and interharmonics measurements and instrumentation, for power supply systems and equipment connected thereto,

IEC 61000-4-15:2003 Electromagnetic compatibility (EMC) – Part 4 Testing and measurement techniques – Section 15: Flickermeter – Functional and design specifications

IEC 61000-4-15:2010 Electromagnetic compatibility (EMC) – Part 4 Testing and measurement techniques – Section 15: Flickermeter – Functional and design specifications

IEC 61000-4-30:2003 Electromagnetic compatibility (EMC) – Part 4-30 Testing and measurement techniques – Power quality measurement methods

IEC 61000-4-30:2015 Electromagnetic compatibility (EMC) – Part 4-30 Testing and measurement techniques – Power quality measurement methods

IEC 62586-1:2013 Power quality measurements in power supply systems – Part 1 Power Quality Instruments (PQI)

IEC 62586-2:2017 Power quality measurements in power supply systems – Part 2 Functional resrs and uncertainty requirements

Eurelectric (Union of the Electricity Industry) publications:

Application guide to the European Standard EN 50160 on Voltage characteristics of electricity supplied by public distribution systems, Ref: 23002 Ren9530, July 1995

Measurement guide for voltage characteristics, Ref: 23002 Ren9531, July 1995

Evaluation Techniques

EN50160 Evaluation Counters

Evaluation Counters and Evaluation Period

The PM180 uses a set of the evaluation counters for collecting EN50160 statistics within a specified evaluation period.

The evaluation period is the period of time within which the device collects statistical evaluation data. Supply voltage characteristics can be evaluated on a weekly or daily basis. The evaluation period normally preset in your device is a week; this can be changed via the EN50160 Advanced setup.

At the end of the evaluation period, the device records collected statistical evaluation data to a log file, then clears the evaluation registers and counters so that each evaluation period's statistics is stored in a separate record.

You can upload and view the online statistics data via PAS reports, using data collected since the beginning of the present evaluation interval. You can also manually clear the present contents of the counters though PAS before starting your EN50160 evaluation.

Observation Period

The observation period is the period of time within which the voltage characteristics shall be assessed to ensure compliance with the standard. The observation periods declared by the

EN50160 may differ for characteristics for which compliance limits are specified in the standard, usually one week, and for those for which only indicative values are provided, usually one year.

The EN50160 compliance reports produced by PAS provide correct weekly and yearly observation statistics regardless of the evaluation periods used for collecting data. Whenever needed, PAS aggregates records within a number of the evaluation intervals to provide correct observation periods. Some of the characteristics, like rapid voltage changes or mains signaling voltage, may require daily assessments. If you intend to use daily-evaluated voltage characteristics, select the daily evaluation period via the EN50160 Advanced setup.

EN50160 Compliance Statistics Log

Data log file #9 is automatically configured in the PM180 for recording EN50160 compliance statistics. Appendix D lists parameters recorded to the file. The file is arranged as a multi-section data log file where each voltage characteristic statistics is stored in a separate section. Along with EN50160 compliance statistics recorded at the end of each evaluation period, file also contains data that may be useful for troubleshooting power quality problems for non-compliant voltage characteristics.

You can upload and view the EN50160 compliance statistics data via PAS reports or via common PAS data logs views.

EN50160 Harmonics Survey Log

Data log file #10 is automatically configured in the PM180 for recording harmonics survey statistics on a weekly or daily basis. You can see parameters recorded to the file in Appendix D. The file stores maximum THD (total, odd and even harmonics) and maximum harmonic voltages up to order 50 collected within each evaluation period.

Harmonics survey is normally intended for troubleshooting harmonic problems throughout electrical networks. It can be separately disabled or enabled in your device via the EN50160 Advanced Setup. The evaluation period for harmonics survey can be selected independently from the EN50160 compliance evaluation.

You can upload and view the harmonics survey data collected by your device via PAS reports or via common PAS data logs views.

EN50160 Power Quality Event Log

The PM180 provides the EN50160 Power Quality (PQ) recorder that can detect EN50160 incidents and record each individual power quality event to the log file with the start and end timestamps and a fault magnitude. It may be useful for troubleshooting problems throughout the electrical network, for example, to identify and locate the source of a power quality event and to select an appropriate solution.

The EN50160 power quality report can be uploaded and viewed via PAS (see [Viewing EN50160 Power Quality Event Log](#)). Transient overvoltages and short-duration voltage dips and temporary overvoltages recorded to the file can also be viewed in PAS as magnitude/duration pairs on the well-known ITIC curve chart for assessing the minimum equipment immunity.

The PQ recorder can trigger the waveform recorder to record the fault waveforms before, during and after the PQ event for detailed event analysis.

Methods of Evaluation

This section describes methods used by the PM180 for evaluating supply voltage characteristics to ensure compliance with the standard.

Frequency Variations

Method of Evaluation

The basic frequency measurement is the mean value of the frequency over fixed time intervals of 10 seconds under normal operating conditions.

A frequency variation is not evaluated if the supply voltage crosses a voltage tolerance limit ($\pm 15\% U_n$).

Target Values

The ranges of frequency variations given in the EN50160 are:

50Hz $\pm 1\%$ for 95% of a week

50Hz $\pm 1\%$ for 99.5% of a year

50Hz+4/-6% for 100% of the time

The same limits are used for 60Hz systems. The frequency compliance limit can be programmed in the device in percent of the nominal power frequency via the EN50160 PQ Recorder setup.

Supply Voltage Variations

This characteristic defines slow variations of steady state supply voltage magnitude.

Method of Evaluation

The basic supply voltage magnitude measurement is the RMS value of the steady state voltage over a period of 10 minutes under normal operating conditions.

A voltage variation is not evaluated if the supply voltage crosses a voltage tolerance limit ($\pm 15\% U_n$).

Target Values

The range of voltage variations given in the EN50160 is:

$\pm 10\% U_n$ for 95% of a week

The supply voltage compliance limit can be changed in the device via the EN50160 PQ Recorder setup.

Rapid Voltage Changes

Rapid voltage changes are sudden but relatively weak voltage variations between two steady state voltage levels.

Method of Evaluation

Evaluation of rapid voltage changes is made on an hourly basis. The RMS voltage is evaluated over 3-second time integration intervals. The device establishes the maximum difference of the RMS voltage between two intervals selected from three 3-second consecutive intervals and compares it with the target compliance limit.

A rapid voltage change is not classified if it crosses a voltage tolerance limit ($\pm 10\% U_n$), as it would be considered a voltage dip or a temporary overvoltage.

Target Values

The maximum rate of rapid voltage changes is normally once per hour or less. For voltage variations repeating more than once an hour, amplitude is limited by the flicker index. The maximum rate of rapid voltage changes in variations per hour can be changed in the device via the EN50160 Advanced Setup. The target magnitude limit of rapid voltage changes can be programmed in the device via the EN50160 PQ Recorder setup.

Under usual operating conditions the magnitude of rapid voltage changes (once per hour or less) should generally not exceed 5% of nominal voltage in LV networks, and 4% in MV networks. In some circumstances, like in systems where equipment switching must be carried out to meet supply system or load requirements, it can reach $10\% U_n$ in LV networks, and $6\% U_n$ in MV networks.

Flicker

Flicker expresses the visual discomfort caused by repetitive changes of brightness in lightning subjected to fluctuations of the supply voltage. Flicker is indicated by the long-term flicker severity parameter Plt, which is evaluated every 2 hours.

Method of Evaluation

The basic flicker measurement is the short-term flicker severity indicator Pst, evaluated each 10 minutes by instrumentation complying with IEC 61000-4-15. The indicative long-term flicker severity Plt is evaluated from 12 consecutive Pst values. For testing purposes, the Pst period can be temporarily changed in the device in the range of 1 to 10 minutes via the EN50160 Advanced Setup.

Pst values are not classified during intervals when the supply voltage magnitude exceeds a voltage tolerance limit ($\pm 15\% U_n$) or is affected by voltage dips with depth more than 15% U_n .

Target Values

The flicker compliance limit given in the EN50160 is:

$$Plt \leq 1 \text{ for 95\% of a week}$$

The Plt compliance limit can be changed in the device via the EN50160 PQ Recorder setup.

Voltage Dips

A voltage dip is a sudden reduction of the RMS voltage below 90% of the nominal value, followed by a return to a value higher than 90% of the nominal in a time varying from 10 ms to 60 s.

Method of Evaluation

A voltage dip is classified as one polyphase event regardless of the shape and of the number of phases affected (as per Eurelectric's Application guide to the European Standard EN 50160, and IEC 61000-4-30). An event can begin on one phase and end on another phase. The fault magnitude is recorded separately for each phase involved. The event duration is measured from the instant at which the voltage falls below the start threshold on one of the phases to that at which it becomes greater than the end threshold on all affected phases including a threshold hysteresis.

The basic voltage dip measurement is one-cycle RMS voltage updated each half-cycle.

The voltage dip threshold can be changed in the device via the EN50160 PQ Recorder setup.

Statistical Results

The PM180 provides the statistical evaluation of voltage dips using the classification established by UNIPeDE. Dips are classified by residual voltage magnitude and duration as shown in Appendix D.

Indicative Values

Under normal operating conditions the expected number of voltage dips in a year may be from up to a few tens to up to one thousand. The majority of voltage dips have duration less than 1 s and a depth less than 60%.

Voltage Interruptions

Voltage interruptions correspond to temporary loss of supply voltage on all phases lasting less than or equal to 3 minutes in the event of short interruptions, and more than 3 minutes for long interruptions.

Method of Evaluation

The voltage interruption is detected when the voltages on all phases fall below the interruption threshold (as per IEC 61000-4-30) specified by the EN50160 at a level of 1% U_n . The interruption threshold can be changed in the device via the EN50160 PQ Recorder setup.

The basic voltage measurement is one-cycle RMS voltage updated each half-cycle.

Statistical Survey

The PM180 provides the statistical evaluation of voltage interruptions using the classification recommended by Eurelectric's Measurement guide for voltage characteristics.

Interruptions are classified by duration as shown in Appendix D.

Indicative Values

Under normal operating conditions the expected number of short voltage interruptions in a year may be from up to a few tens to up to several hundreds. Short interruptions generally last less than a few seconds.

The annual frequency of long interruptions may be less than 10 or up to 50 depending on the area.

Temporary Overvoltages

Temporary overvoltages are sudden rises of the voltage RMS value of more than 110% of nominal voltage. Temporary overvoltages may last between 10 milliseconds and one minute.

Method of Evaluation

A temporary overvoltage is classified as one polyphase event regardless of the shape and of the number of phases affected (as per IEC 61000-4-30). An event can begin on one phase and end on another phase. The fault magnitude is recorded separately for each phase involved. The event duration is measured from the instant at which the voltage rises above the start threshold on one of the phases to that at which it becomes lower than the end threshold on all affected phases including a threshold hysteresis.

The overvoltage threshold can be changed in the device via the EN50160 PQ Recorder setup.

The basic voltage measurement is one-cycle RMS voltage updated each half-cycle.

Statistical Survey

The PM180 provides the statistical evaluation of temporary overvoltages using the classification recommended by Eurelectric's Measurement guide for voltage characteristics. Temporary overvoltages are classified by voltage magnitude and duration as shown in Appendix D.

Indicative Values

Temporary overvoltages on the low voltage side will generally not exceed 1.5 kV RMS.

Transient Overvoltages

Transient overvoltages correspond to disturbances of very short duration, lasting typically less than one half-cycle, i.e. a few microseconds to several milliseconds.

Method of Evaluation

Transient overvoltages are detected as impulsive transients with a rise time less than 0.5 ms and duration from 80 μ s to $\frac{1}{2}$ cycle. The impulse magnitude is evaluated by the peak voltage value and is referenced to the nominal peak voltage ($1.414 U_n$). The device can detect transient overvoltages with a magnitude of up to 700V.

Statistical Survey

The PM180 provides the statistical evaluation of transient overvoltages using the classification recommended by Eurelectric's Measurement guide for voltage characteristics. Transient overvoltages are classified by voltage magnitude as shown in Appendix D.

Indicative Values

Temporary overvoltages in LV systems will generally not exceed 6 kV peak, but higher values occur occasionally.

Voltage Unbalance

This characteristic defines the magnitude and/or phase asymmetries of three-phase steady state supply voltage.

Method of Evaluation

The basic measurement is the RMS value of the steady state voltage unbalance over a period of 10 minutes under normal operating conditions. It is defined using the theory of symmetrical components by the negative sequence component expressed in percent of the positive sequence component.

Voltage unbalance is not evaluated if the supply voltage crosses a voltage tolerance limit ($\pm 15\% U_n$).

Target Values

The range of voltage unbalance given in the EN50160 is:

$$\leq 2\% (\leq 3\% \text{ in some areas}) \text{ for } 95\% \text{ of a week}$$

The voltage unbalance compliance limit can be changed in the device via the EN50160 PQ Recorder setup.

Harmonic Voltage

Method of Evaluation

The basic measurements are the individual harmonic voltage distortion factors (HD) and the total harmonic distortion factor (THD) over a period of 10 minutes under normal operating conditions.

Harmonic voltages are evaluated by instrumentation complying with IEC 61000-4-7. All calculations are made relative to the nominal voltage.

THD is evaluated including all harmonics up to the order 40. Harmonic voltages are evaluated up to the order 25 since the EN50160 provides target values for individual harmonic voltages only for orders up to 25. The highest harmonic order for evaluating individual harmonic voltages and THD can be changed in the device in the range of 25 to 50 via the EN50160 Advanced Setup.

Harmonic voltages are not evaluated if the supply voltage crosses a voltage tolerance limit ($\pm 15\% U_n$).

Target Values

The ranges of harmonic voltages given in the EN50160 are:

THD \leq 8% for 95% of a week

Individual harmonic voltages shall be less than or equal to the values given in Table 1 in Clause 2.11 of the EN50160 for 95% of a week.

The THD compliance limit can be changed in the device via the EN50160 PQ Recorder setup. The individual harmonic voltage limits can be adjusted via the EN50160 Harmonics setup.

Interharmonic Voltage

Method of Evaluation

Since the EN50160 does not specify target limits for interharmonic voltages, this feature is normally disabled. You can enable evaluation of interharmonic voltages via the EN50160 Advanced Setup.

The basic measurements are the individual interharmonic voltage distortion factors (HD) and the total interharmonic distortion factor (THD) over a period of 10 minutes under normal operating conditions.

Interharmonic voltages are evaluated by instrumentation complying with IEC 61000-4-7. All calculations are made relative to the nominal voltage.

The highest harmonic order for evaluating individual interharmonic voltages and interharmonic THD can be selected in the device in the range of 25 to 50 via the EN50160 Advanced setup.

Interharmonic voltages are not evaluated if the supply voltage crosses a voltage tolerance limit ($\pm 15\%$ Un).

Target Values

The EN50160 does not provide target limits for interharmonic voltages. The ranges of interharmonic voltages selected in the PM180 are:

Interharmonic THD \leq 2% for 95% of a week

Individual interharmonic voltages shall be less than or equal to the values given in the following table for 95% of a week.

Interharmonic order	Relative Voltage
2	0.2
3-15	1.0
16-25	0.5

You can change the compliance limit for the interharmonic THD via the EN50160 PQ Recorder setup. The individual interharmonic voltage limits are changed via the EN50160 Harmonics setup.

Mains Signaling Voltage

This characteristic defines the magnitude of the signal voltages used in some countries for signal transmission over public supply networks. These may include ripple control signals in a frequency range from 100 Hz to 3 kHz, and carrier wave communications signals in a frequency range from 3 kHz to 148.5 kHz.

The PM180 evaluates ripple control signaling voltages in a frequency range from 100 Hz to 3 kHz.

Method of Evaluation

Since evaluating signal voltages is not commonly used, this feature is normally disabled. You can enable evaluation of signaling voltages via the EN50160 Advanced Setup.

The PM180 can evaluate up to four ripple control frequencies. You can select the required signaling frequencies via the EN50160 Advanced Setup.

The basic measurement is the magnitude of the signaling voltage over a period of 3 seconds under normal operating conditions.

Signaling voltages are not evaluated if the supply voltage crosses a voltage tolerance limit ($\pm 15\%$ Un).

Target Values

The voltage levels given by the EN50160 in Figure 1 of Clause 2.13 are taken from the so-called "Meister-curve" which defines the maximum permissible ripple control voltages in LV networks.

Compliance with the EN50160 requires that the 3-second mean of signal voltages shall be less or equal to the specified limits for 99% of a day.

Configuring the EN50160 Recorders

Basic Device Settings

The following device settings affect the EN50160 evaluation and should be checked prior to running the EN50160 recorders.

Reference Voltage

As the general approach of the EN50160, all voltage characteristics are referenced to the nominal voltage that shall be specified in the PM180 by the secondary line-to-line voltage (see Basic Device Setup) regardless of the wiring mode. The nominal voltage refers to the line-to-neutral supply voltage in LV networks (4LN3, 3LN3 or 3BLN3 wiring modes), and to line-to-line voltage in MV networks (4LL3, 3LL3, 3BLN3, 3OP2, 3OP3 and 3DIR2 wiring modes).

Reference Frequency

The nominal line frequency is used as a reference for the evaluation of power frequency variations. It should be specified in your device before running the EN50160 recorders (see [Basic Device Setup](#)).

EN50160 Evaluation Limits and Options

Limits for evaluation of the EN50160 voltage characteristics may be set via the [EN50160 PQ Recorder Setup](#) and, for harmonic and interharmonic voltages, via the EN50160 Harmonics setup (see [EN50160 Harmonics Limits Setup](#)).

The EN50160 evaluation options can be changed via the [EN50160 Advanced Setup](#).

EN50160 Logging Options

The memory allocated in your device for the EN50160 compliance statistics and harmonics survey data is sufficient for 3-month data recording on a weekly basis. The Power Quality event log file is configured for 1000 event records. You can increase or change the size of the EN50160 data log files in your device via the Log Memory Setup (see [Configuring Device Memory](#)).

EN50160 PQ Recorder Setup

The PQ recorder setup allows you to adjust the EN50160 evaluation limits (thresholds) for the specific voltage characteristics in the case the customer requirements differ from the values provided by the EN50160, and to select the event and waveform log options for the PQ event log.

To configure the PQ recorder:

1. Select Memory/Log from the Meter Setup menu, and then click on the EN50160 PQ Recorder tab.
2. Adjust thresholds and hysteresis for PQ triggers if required. The harmonic and interharmonic voltage limits can be individually set for each harmonic order via the EN50160 Harmonics setup. Limits for the signaling voltage frequencies are automatically taken from the “Meister-curve”.
3. Check the Enabled box for the voltage characteristics you want to be recorded to the PQ event log. You can individually enable or disable recording PQ events related to specific characteristics. Notice that the interharmonic voltage and mains signaling voltage evaluation should be also enabled in the device via the EN50160 Advanced Setup.

Disabling recording events to the PQ log does not prevent the evaluation of the voltage characteristics and collecting the EN50160 statistics for these events.

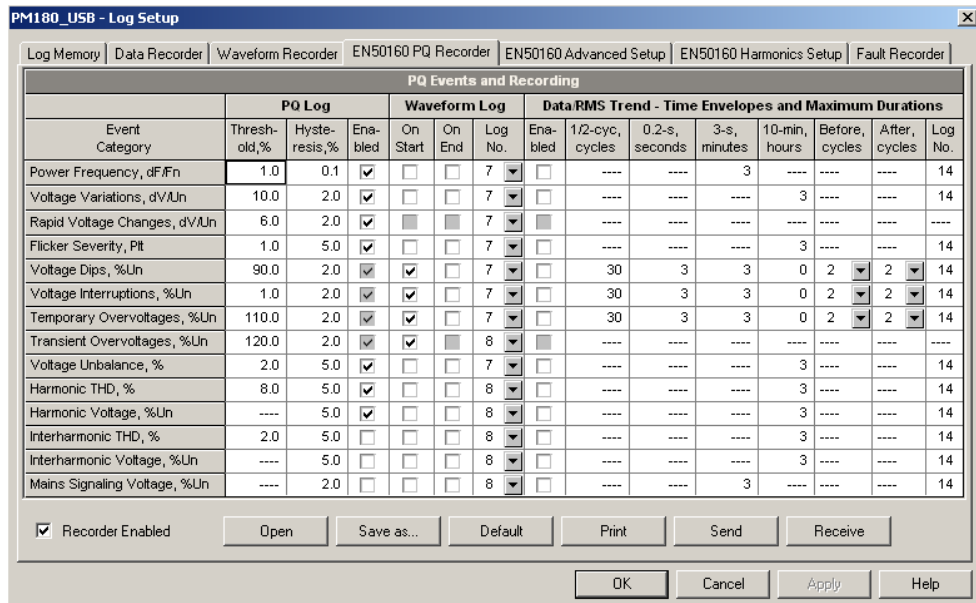

Figure 7-1 EN50160:2007 PQ recorder

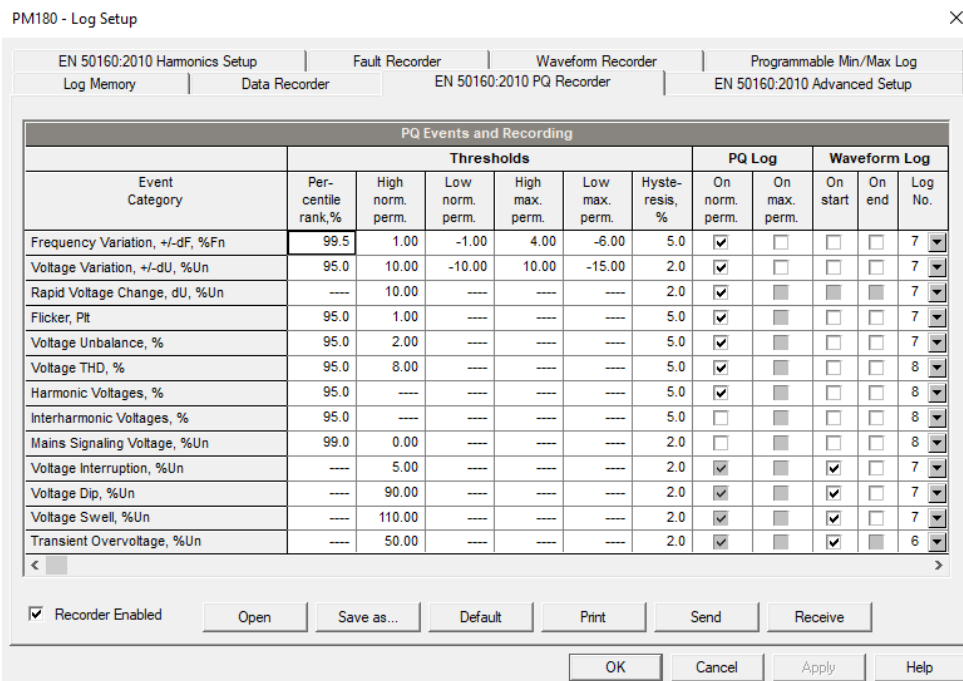

Figure 7-2 EN50160:2010 PQ recorder

4. Select the waveform logging options for PQ events.
5. Download your setup to the device.

The picture above shows the default PQ recorder settings. The available options are listed in the following table.

Option	Range	Default	Description
PQ Log			
Threshold, %	0-200.0%		Defines the operating threshold for the PQ trigger in percent of the nominal (reference) value
Hysteresis, %	0-50.0%		Defines the hysteresis for the PQ trigger in percent of the threshold

Option	Range	Default	Description
Enabled	Checked Unchecked		Enables recording PQ events for specific voltage characteristics
Waveform Log			
On Start	Checked Unchecked	Checked	Enables waveform log when the PQ event starts
On End	Checked Unchecked	Unchecked	Enables waveform log when the PQ event ends
Log No.	7-8		Specifies the waveform log file used for waveform recording on the PQ event

The waveform log options allow recording waveforms both at the start and the end of a PQ event. Since the voltage variations can last from some seconds to minutes, this allows capturing and analyzing the voltage transitions using short time waveform recording at the start and at the end of the voltage sag or swell.

You can temporary disable the PQ recorder in your device. To enable or disable the PQ recorder:

1. Check or uncheck the “Recorder Enabled” checkbox.
2. Send your setting to the device.

Note that disabling the PQ recorder in your device does not affect the evaluation and recording of the EN50160 statistics.

Power Quality Event Indication and Cross Triggering

When the PQ recorder detects a power quality fault, it generates the specific internal event PQ EVENT that can be monitored through a control setpoints to give a fault indication via relay contacts. The event can be found under the STATIC EVENTS group in the setpoints trigger list.

The power quality fault signal is used for cross triggering multiple recorders through a dedicated digital input in order to simultaneously record disturbances at different locations. External triggering of the Waveform and Data recorders for recording disturbance data is done through a setpoints programmed to monitor the status of a digital input. For more information on cross triggering, see [Fault Indication and Cross Triggering](#).

EN50160 Harmonics Limits Setup

This setup allows you to adjust compliance limits for harmonic and interharmonic voltages.

To change the default limits in your device:

1. Select Memory/Log from the Meter Setup menu, and then click on the EN50160 Harmonics setup tab.

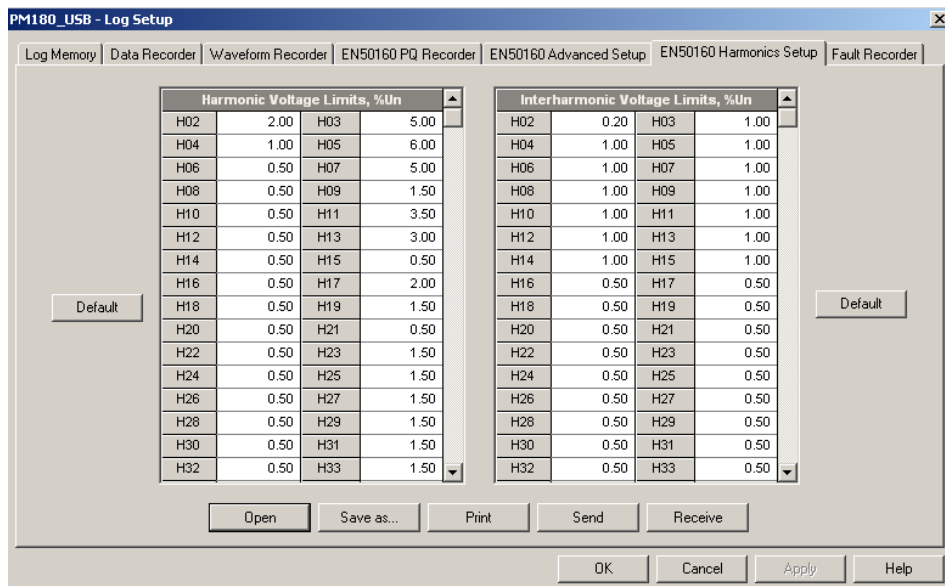

2. Adjust limits you want to change.
3. Download your setup to the device.

The default EM50160 compliance limits are shown in the picture above. You can change the number of the evaluated harmonics and interharmonics via the [EN50160 Advanced Setup](#).

EN50160 Advanced Setup

The EN50160 Advanced Setup allows you to configure the EN50160 evaluation options in your device.

To configure the EN50160 evaluation options:

1. Select Memory/Log from the Meter Setup menu, and then click on the EN50160 Advanced Setup tab.
2. Change the EN50160 evaluation options if required.
3. Download your setup to the device.

The default EN50160 evaluation options set in your device are shown in the picture below.

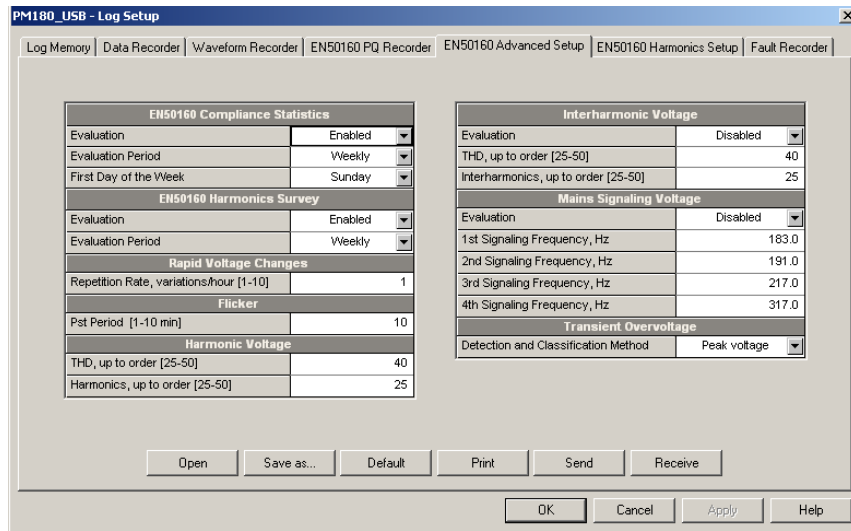

Figure 7-3 EN50160:2007 Advance Setup

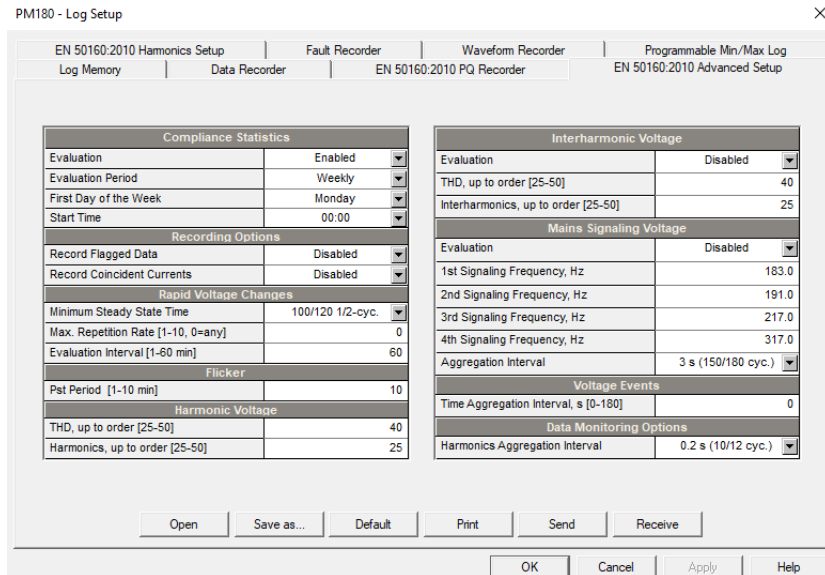

Figure 7-4 EN50160:2010 Advance Setup

The available options are listed in the following table.

Option	Range	Default	Description
EN50160 Compliance Statistics			

Option	Range	Default	Description
Evaluation	Disabled, Enabled	Enabled	Enables the EN50160 evaluation
Evaluation Period	Daily, Weekly	Weekly	Defines the EN50160 statistics evaluation period
First Day of the Week	Sunday-Saturday	Sunday	Defines the first day of the week for statistics evaluated on a weekly basis
EN50160 Harmonics Survey			
Evaluation	Disabled, Enabled	Enabled	Enables the harmonics survey log
Evaluation Period	Daily, Weekly	Weekly	Defines the harmonics survey evaluation period
Rapid Voltage Changes			
Repetition Rate	1-10	1	Defines the maximum repetition rate in variations per hour (equal or less than) for rapid voltage changes. Voltage changes at higher rates are not classified since they will be subject for flicker.
Flicker			
Pst Period	1-10 min	10 min	Defines the period of time for the short-term flicker evaluation. The standard setting of 10 minutes can be temporarily changed in the device for testing purposes.
Harmonic Voltage			
THD, up to order	25-50	40	Defines the highest harmonic order included in the THD evaluation.
Harmonics, up to order	25-50	25	Defines the highest harmonic order for evaluation of the harmonic voltages.
Interharmonic Voltage			
Evaluation	Disabled, Enabled	Disabled	Enables the evaluation of the interharmonic voltages
THD, up to order	25-50	40	Defines the highest interharmonic order included in the THD evaluation.
Interharmonics, up to order	25-50	25	Defines the highest harmonic order for evaluation of the interharmonic voltages.
Mains Signaling Voltage			
Evaluation	Disabled, Enabled	Disabled	Enables the evaluation of the mains signaling voltages
1st Signaling Frequency	110-3000 Hz	183.0 Hz	Specifies the mains signaling frequency for the compliance evaluation
2nd Signaling Frequency	110-3000 Hz	191.0 Hz	Specifies the mains signaling frequency for the compliance evaluation
3rd Signaling Frequency	110-3000 Hz	217.0 Hz	Specifies the mains signaling frequency for the compliance evaluation
4th Signaling Frequency	110-3000 Hz	317.0 Hz	Specifies the mains signaling frequency for the compliance evaluation

Clearing EN50160 Evaluation Counters

To clear the present contents of the EN50160 evaluation counters before starting your EN50160 evaluation, check the On-line button, select Reset from the Monitor menu, and then Click on the “Clear Operatio/Event Counters” button (for more information, see [Resetting Accumulators and Clearing Log Files](#)).

Configuring the Fault Recorder

The Fault recorder automatically records all fault events to the Fault log and to the Sequence-of-Events log files. It can be triggered via the embedded fault detector, or externally through any of the 48 digital inputs.

The Fault recorder can be globally disabled or enabled in your device.

The Fault recorder setup allows you to adjust thresholds and hysteresis for different fault triggers, and to define the waveform and data log options for synchronous recording during the fault events.

To configure the Fault recorder:

1. Select Memory/Log from the Meter Setup menu, and then click on the Fault Recorder tab.
2. Enable fault triggers suitable for your application. Each one, except of the external digital triggers, must be individually enabled for the Fault recorder.
3. If you wish to change the default settings, adjust thresholds and hysteresis for your fault triggers.
4. Select the waveform and data logging options for fault events.

5. Download your setup to the device.

The following table lists available Fault recorder options:

Option	Range	Default	Description
Thresholds			
Threshold, %	0-200.0%		Defines the operating threshold for the fault trigger in percent of the nominal (reference) value
Threshold, secondary			Shows the setup value in secondary units for the selected operating threshold
Hysteresis, %	0-50.0%	5.0	Defines the hysteresis for fault trigger in percent of the threshold
Trigger Enabled	Checked Unchecked	Checked	Links the fault trigger to the Fault Recorder. If the box is leaved unchecked, the Fault Recorder does not respond to the trigger.
Waveform Log			
On Start	Checked Unchecked	Checked	Enables waveform log when the fault event starts
On End	Checked Unchecked	Unchecked	Enables waveform log when the fault event ends
Log No.	1-8	7	Specifies the waveform log file used for waveform recording on the fault event
1/2-cycle RMS Plot			
Log Enabled	Checked Unchecked	Unchecked	Enables concurrent RMS trace plot to the data log file while the fault event continues
Max. Duration	0-10,000 cycles	100	Maximum duration of the 1/2-cycle data trend log. The logging is stopped automatically when either a fault event ends or the specified number of cycles has been recorded.
Before, Cycles	0-20 cycles	4	The number of cycles to be recorded prior to the event
After, Cycles	0-20 cycles	4	The number of cycles to be recorded after the event
Log No.	13	13	Specifies the data log file used for data recording on the fault event

To enable or disable the Fault recorder in your device:

1. Check or uncheck the “Recorder Enabled” checkbox.
2. Send the new setting to the device.

In IEEE 1159 versions, current and voltage faults detected by the Fault recorder are normally recorded into the IEEE 1159 Power Quality log file. To disable this option:

1. Uncheck the “Record to PQ Log” checkbox.
2. Send the new setting to the device.

Configuring Analog Triggers

Voltage and current thresholds are normally specified as a percent of a nominal (reference) voltage and current. The voltage reference is the line-to-neutral PT secondary voltage for the 4LN3, 3LN3 and 3BLN3 wiring configurations, and the line-to-line PT secondary voltage for other wiring configurations. The reference value for current triggers is the CT secondary current rating for the extended range current inputs. See [Basic Device Setup](#) in Chapter 6 for information on specifying voltage and current ratings in your device.

To make easier specifying thresholds for voltage and current triggers, PAS also shows you threshold values in secondary units that match the percentage you selected for the triggers. To update the thresholds in secondary units, type the threshold for a trigger in percent, and then press Enter or click elsewhere on the Fault Recorder setup tab.

The picture above shows the factory set Fault recorder options. Notice that the Overcurrent trigger can be used along with the second Undervoltage trigger combined by logical AND. If you wish to use the only Overcurrent trigger, disable (uncheck) the second Undervoltage trigger.

The **Zero-Sequence Voltage** trigger and the **Voltage Unbalance** trigger are disabled by default. Both are very sensitive to phase unbalances. If you want to use them, adjust the thresholds according to your network conditions before enabling triggers.

The **Current Unbalance** trigger has a different calculation algorithm than the common current unbalance measurements. Since the unbalance readings give a relation of the maximum deviation from the average to the phase average current, the value could produce high readings for low currents and may not be used as a fault trigger. The Current Unbalance trigger used with the Fault recorder shows a relation to the CT rated current instead of the three-phase average and is not sensitive to low currents.

Configuring Digital Triggers

If you use external triggering of the Fault recorder through digital inputs, you should individually link each digital input to the Fault recorder (see [Configuring Digital Inputs](#) in Chapter 6). The external triggering is enabled for the Fault recorder by default and cannot be disabled by the user.

Fault Indication and Cross Triggering

When the Fault recorder is triggered either by the fault detector or through digital inputs, it generates a number of specific internal events that can be monitored through the control setpoints to give a fault indication via relay contacts. The following describes fault events produced by the Fault recorder:

1. **FAULT DETECTED** - the fault detector has detected a fault event using the device's own measurements
2. **EXTERNAL TRIGGER** - the Fault recorder has been launched by an external trigger through one of the digital inputs
3. **FAULT EVENT** - the Fault recorder has been launched either by its own fault detector, or by an external trigger

These events can be found under the STATIC EVENTS group in the setpoint trigger list (STATIC in this context means that an event is asserted all the time while its fault condition exists).

The FAULT DETECTED event can be effectively used for cross triggering multiple fault recorders to simultaneously record fault data at different locations when one of the devices detects a fault. Each device should have a setpoint programmed to close relay contacts on the FAULT DETECTED event, and one digital input linked to the Fault recorder.

To provide cross triggering, the triggering digital inputs of all devices should be tied together and connected to the normally opened relay contacts that indicate a fault. To avoid self-triggering through its own digital input for the device that indicates a fault, it is recommended to use a Form C relay and to connect the digital input through the normally closed contacts. Thus, the device that indicates a fault disconnects its digital input before giving a fault out.

Configuring the Fault Locator

This section describes the predefined parameters while installing the IED.

- Sites parameters:
 - Name of Substation where locator is installed
 - Name of the Power Line
 - Line type (Single, parallel, party parallel, branch with transformer)
 - Using of Current input I4 (not used, own neutral current, neutral current of parallel line)
 - Length of the power line
 - Length of the parallel line
 - Digital input number of the locator, used for connection to relay protection output
 - Digital input number of the locator, used for connection to circuit breaker block-contact
 - Number parts of power line having different impedances of 1 km (up to 4 parts)

PM180 - Fault Locator Setup

Fault Locator Setup

Station	
Station Name	Substation 1
Line	
Line Name	220kV Line Haifa - Hadera
Line Type	Single
I4 Current Input	Not used
Power Line Length, km	60.00
Parallel Line Length, km	----
External Triggers	
Protection Relay	NONE
Breaker Contacts	NONE

Line Impedance		
Number of Segments	4	Setup
Capacitance per km, F/(km*10 ⁻⁴)	----	
Parallel Line Mutual Reactance, Ohm/km	----	
Transformer on Branch		
Line to branch & Power system impedance, Ohm	----	Setup
Instrument Transformer Correction		
Current Transformer Correction, No. of Ranges	6	Setup
Voltage Transformer Correction, No. of Ranges	4	Setup

Correction Enabled

Open Save as... Default Print Send Receive

OK Cancel Apply Help

- Impedance of 1 km power line for each part of line (up to 4 groups):
 - Positive sequence resistance, Ohm/km,
 - Positive sequence reactance, Ohm/km,
 - Zero sequence resistance, Ohm/km,
 - Zero sequence reactance, Ohm/km
- Capacitance of 1 km line , Ohm/km
- Impedance of 1 km parallel line
 - Mutual reactance, Ohm/km.
- Data of line branch with power transformer
 - Power line impedance up to branch
 - Zero sequence resistance, Ohm
 - Zero sequence reactance, Ohm
- Power system impedance
 - Zero sequence resistance, Ohm
 - Zero sequence reactance, Ohm
- Power transformer impedance
 - Zero sequence resistance, Ohm
 - Zero sequence reactance, Ohm

Line Impedance

Power Line Impedance					
No.	Segment Length, km	Pos. Sequence Resistance, Ohm/km	Pos. Sequence Reactance, Ohm/km	Zero Sequence Resistance, Ohm/km	Zero Sequence Reactance, Ohm/km
1	100.00	0.2500	0.2500	0.5000	2.5000
2	100.00	0.2500	0.2500	0.5000	2.5000
3	100.00	0.2500	0.2500	0.5000	2.5000
4	100.00	0.2500	0.2500	0.5000	2.5000

OK Default Cancel

- Data for correction of current transformer errors, number of parts current error characteristic (up to 6)

Correction coefficients:

- for current 0 to 50% I_n - r.m.s. x1,%, angle y1, min
- for current 50 to 150% - r.m.s. x2,%, angle y2, min
- for current 150 to 400% - r.m.s. x3,%, angle y3, min

- for current 400 to 1000% - r.m.s. x4,%, angle y4, min
- for current 1000 to 2000% - r.m.s. x5,%, angle y5, min
- for current 2000 to 3000% - r.m.s. x5,%, angle y6, min

Instrument Transformer Correction

Current Transformer Correction			
No.	Upper Test Point, Im/In	Ratio Correction Factor	Phase Angle Error, min
1	5.0	1.000	0
2	9.0	1.000	0
3	13.0	1.000	0
4	16.0	1.000	0
5	18.0	1.000	0
6	20.0	1.000	0

OK Default Cancel

- Data for correction of voltage transformer errors, number of parts voltage error characteristic (up to 4)

Correction coefficients:

- for voltage 0 to 10% Vn - r.m.s. x1,%, angle y1, min
- for voltage 10 to 25% - r.m.s. x2,%, angle y2, min
- For voltage 25 to 50% - r.m.s. x3,%, angle y3, min
- for voltage 50 to 110% - r.m.s. x4,%, angle y4, min

Instrument Transformer Correction

Voltage Transformer Correction			
No.	Upper Test Point, Um/Un	Ratio Correction Factor	Phase Angle Error, min
1	0.10	1.000	0
2	0.25	1.000	0
3	0.50	1.000	0
4	1.10	1.000	0

OK Default Cancel

- Fault voltage and current r.m.s. of own end of power line (for three phases and neutral) for each cycle with time stamp and update a half cycle (up to 32 cycles)
- Data about opposite end of the power line
 - Name of Substation where second locator is installed
 - Address of the second locator
- Fault voltage and current r.m.s. (for three phases and neutral) for each cycle with time stamp and update a half cycle

Fault Location calculations results

- Definitions
 - Names of faulted phases (AG, BG, CG, AB, BC, CA, ABG, BCG, CAG, ABC and Broken phase line A or B or C)
 - Distance to fault [km] or [miles]
 - Duration of fault [sec], from 0.02s to 20s with 0.01s resolution
- Fault Parameters names:
 - FITm: Fault Time
 - FitTmmcs:
 - FitLoop: Fault Loop
 - FitDis: Fault Distance in km or miles
 - FitAcc%: Fault accuracy in %
 - FitR: Fault Resistive value
 - FitX: Fault complex value

Set the Distance to Fault Log Enabled flag.

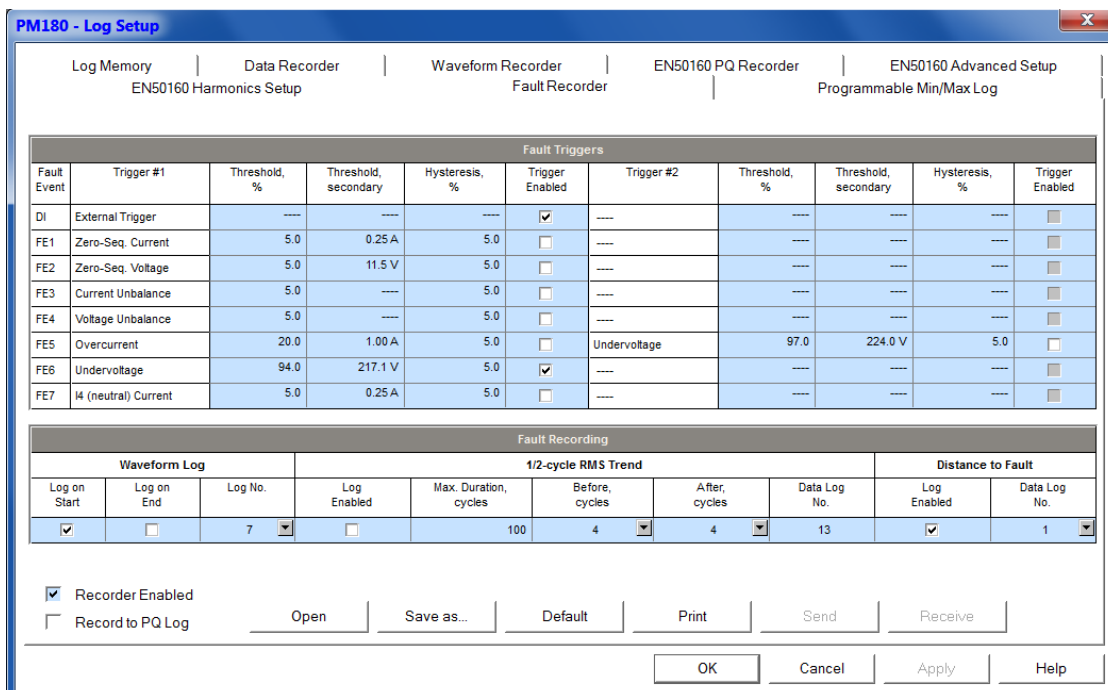

Set Data Log #1 with Distance to Fault parameters to retrieve them remotely.

PM180 - Log Setup

EN50160 Harmonics Setup | Fault Recorder | Programmable Min/Max Log
 Log Memory | Data Recorder | Waveform Recorder | EN50160 PQ Recorder | EN50160 Advanced Setup

Log No: Name:

Data Log Parameters					
No.	Group	Parameter	No.	Group	Parameter
1	RMS (1 min)	V1	9	Distance to Fault	FtR
2	RMS (1 min)	V2	10	Distance to Fault	FtX
3	RMS (1 min)	V3	11	----	NONE
4	Distance to Fault	FtTn	12	----	NONE
5	Distance to Fault	FtTmcs	13	----	NONE
6	Distance to Fault	FtLoop	14	----	NONE
7	Distance to Fault	FtDis	15	----	NONE
8	Distance to Fault	FtAcc%	16	----	NONE

Open Save as... Clear Clear All Print Send Receive

OK Cancel Apply Help

Chapter 8 Totalization Energy and TOU Registers

The PM180 provides 16 summary energy registers and 16 parallel TOU energy and maximum demand registers to link to any internal energy source or to any external pulse source that delivers energy pulses through the device digital inputs.

A total of 64 energy sources can be connected to the summary and TOU registers. Each summary register can accumulate energies from multiple sources using arithmetic addition and subtraction. A summary register may be linked to another summary register to provide more comprehensive energy calculations.

The TOU system provides for each TOU energy register a parallel maximum demand register that is updated automatically when a corresponding TOU register is activated. The device supports 16 different tariffs using an arbitrary tariff structure.

The PM180 TOU system technique is based on the currently active TOU annual calendar that assigns the user-selectable daily profile to each day of the year. The TOU daily profiles specify daily tariff change points. The PM180 memory stores calendars for 10 years. A total of 16 types of days are supported with up to eight tariff changes per day.

By default, the summary registers in your device are not linked to energy sources and are not operational. To activate a summary energy register, link it to the energy source(s).

To activate TOU system:

1. Configure the TOU daily profiles for different types of days.
2. Configure the TOU calendars.
3. Link the TOU registers to the corresponding summary energy registers that are used as source registers for TOU system.

Configuring Summary and Billing/TOU Registers

To configure the device summary and Billing/TOU registers, select Energy/TOU from the Meter Setup menu.

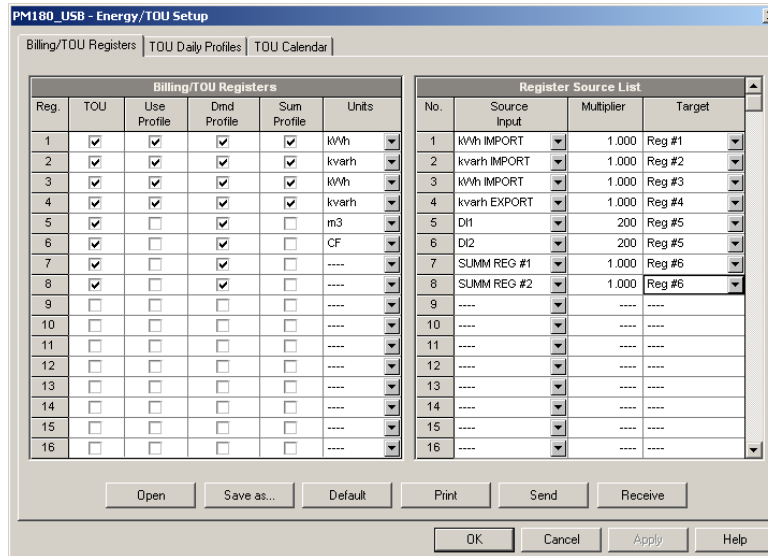

The available options are described in the following table:

Parameter	Options	Default	Description
Billing/TOU Registers			
TOU	Unchecked Checked	Unchecked	Links multi-tariff registers to the selected energy source
Use Profile	Unchecked Checked	Unchecked	Enables recording energy registers in monthly/daily billing profile files (both total and tariff registers if TOU is enabled).

Parameter	Options	Default	Description
Dmd Profile	Unchecked Checked	Unchecked	Enables recording maximum demand registers in monthly/daily billing profile files (both total and tariff registers if TOU is enabled)
Sum Profile	Unchecked Checked	Unchecked	Enables recording total (summary) registers in monthly/daily billing profile files.
Units	None kWh kvarh kVAh m3 CF CCF	None	The energy register measurement unit.
Register Source List			
Source Input	None kWh IMPORT kWh EXPORT kvarh IMPORT kvarh EXPORT kvarh Q1 kvarh Q2 kvarh Q3 kvarh Q4 kVAh kVAh IMPORT kVAh EXPORT DI1-DI48 SUMM REG #1 - 16	None	Links an internal or external energy source to the billing register.
Multiplier	0.001 to 100.000	1.000	The multiplication factor for the energy source.
Target	Reg#1- Reg#10	None	Defines the target summary register for the energy source.

Configuring TOU Daily Profiles

To configure the TOU daily profiles, select Energy/TOU from the Meter Setup menu, and then click on the TOU Daily Profiles tab.

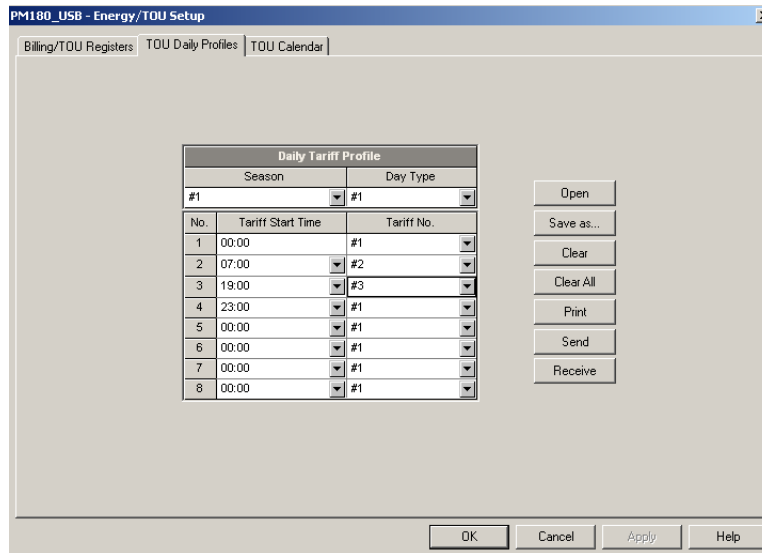

The profile setup allows you to specify the daily tariff change points with a 15-minute resolution.

To configure your daily profiles:

1. Select the desired season and day type
2. Select the start time for each tariff change point and the corresponding active tariff number.
3. Repeat the setup for all seasons and types of day.

The first tariff change point is fixed at 00:00 hours, and the last tariff change you specified will be in use until 00:00 hours on the next day.

Note: The billing monthly and daily profile files, and your billing data display are automatically configured for the number of active tariffs you defined in the meter TOU daily profile

Configuring TOU Calendar

The Pm180 TOU calendar provides a season tariff schedule and an option for scheduled daylight savings switch dates.

To configure your season tariff schedule, select Energy/TOU from the Meter Setup menu, and then click on the TOU Calendar tab.

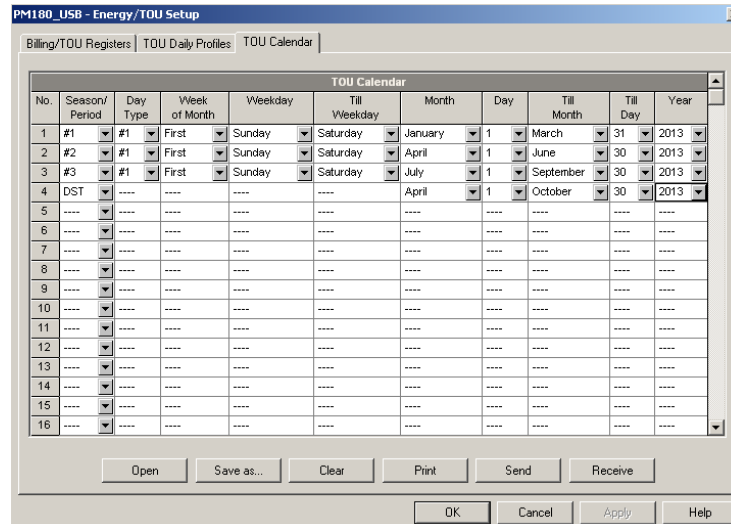

The meter TOU calendar allows you to configure any tariff schedule based on any possible utility regulation. The calendar provides 48 entries that allow you to specify profiles for working days and holidays through all seasons in any order that is convenient for you, based on simple intuitive rules. There are no limitations on how to define your schedule. The meter is able to automatically recognize your settings and to select a proper daily tariff schedule for any day within a year.

To configure your season tariff schedule:

1. In the "Season/Period" box, select the season, and in the "Day Type" box, select a day type for this calendar entry.
2. Select the time interval when this daily tariff schedule is effective, based on the start and the end weekdays and, for a multi-season schedule, on the start and the end month for the selected season. It does not matter which order of weekdays or months you select: the meter recognizes the correct order.
3. For exception days like designated holidays, select a specific day either by specifying a day and month, or by selecting a month, a week and a weekday within the month.

NOTE: The PM180 TOU calendar provides an embedded schedule of Hebrew holidays till 2039 for Israeli customers. To enable the automatic holiday schedule, select Israel in the Country box in the Local Settings setup (see Local Settings)

To configure your DST schedule:

1. Select DST in the "Season/Period" box.
2. Select the DST start month and day in the "Month" and "Day" boxes.
3. Select the DST end month and day in the "Till Month" and "Till Day" boxes.
4. In the "Year" box, select a year for which these dates will be effective.
5. Repeat steps 2-4 for all years for which you wish to provide a DST schedule.

To make your DST schedule effective:

1. Go to the Local Settings setup (see Local Settings).

2. Select "Scheduled" in the Daylight Saving Time (DST) box.
3. Send your new setting to the meter.

Chapter 9 Configuring Communication Protocols

This section describes how to customize protocol options for use with your application software.

Configuring MODBUS

MODBUS Point Mapping

The PM180 provides 120 user assignable registers in the address range of 0 to 119. You can re-map any register available in the device to any assignable register so that Modbus registers that reside at different locations may be simply accessed using a single request by re-mapping them to adjacent addresses.

Initially these registers are reserved and none of them points to an actual data register. To build your own MODBUS register map:

1. From the Meter Setup menu select Protocol Setup and click on the MODBUS Registers tab.
2. Click on the Default button to cause the assignable registers to reference the actual default device register 11776 (0 through 119 are not allowable register addresses for re-mapping).
3. Type in the actual addresses you want to read from or write to via the assignable registers. Refer to the PM180 MODBUS Reference Guide for a list of the available registers. Note that 32-bit MODBUS registers should always start at an even register address.

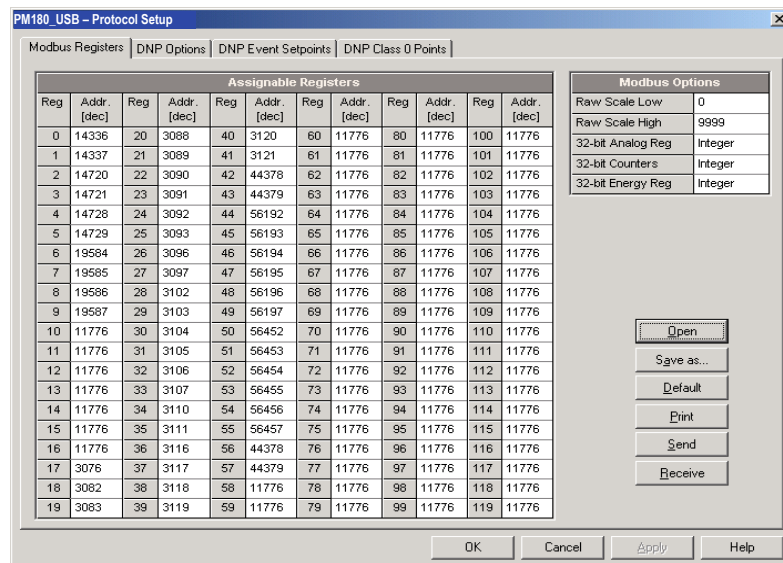

4. Click Send to download your setup to the device.

Changing Raw Scales for 16-bit Registers

16-bit analog registers are normally read with scaling to the default range of 0 to 9999. Refer to the PM180 MODBUS Reference Guide for more information on scaling 16-bit MODBUS registers.

To change the default low and high raw scales:

1. From the Meter Setup menu select Protocol Setup and click on the Modbus Registers tab.
2. Change the raw scales in the Modbus Options pane. The allowable range is 0 to 65535.
3. Click Send to download your setup to the device.

Configuring DNP3

DNP Options can be changed both via DNP3 and Modbus. Refer to the PM180 DNP3 Reference guide for information on the protocol implementation and a list of the available data points.

DNP Options

From the Meter Setup menu select Protocol Setup and click on the DNP Options tab.

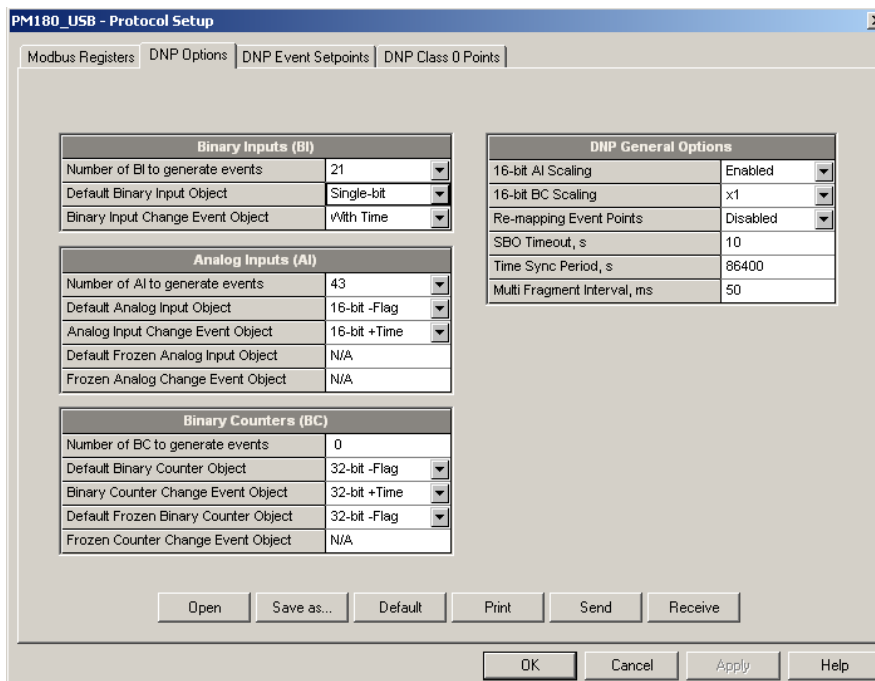

The following table describes available DNP options. Refer to the DNP3 Data Object Library document available from the DNP User's Group on the DNP3 object types.

Parameter	Options	Default	Description
Binary Inputs (BI)			
Number of BI to Generate events	0-64 ³	21	The total number of BI change event points for monitoring
Binary Input Object	Single-bit With Status	Single-bit	The default BI object variation for requests with qualifier code 06 when no specific variation is requested
Binary Input Change Event Object	Without Time With Time	With Time	The default BI change event object variation for requests with qualifier code 06 when no specific variation is requested
Analog Inputs (AI)			
Number of AI to Generate events	0-64 ³	43	The total number of AI change event points for monitoring
Analog Input Object	32-bit 32-bit -Flag 16-bit 16-bit -Flag	16-bit -Flag	The default AI object variation for requests with qualifier code 06 when no specific variation is requested
Analog Input Change Event Object	32-bit -Time 32-bit +Time 16-bit -Time 16-bit +Time	16-bit +Time	The default AI change event object variation for requests with qualifier code 06 when no specific variation is requested
Binary Counters (BC)			
Number of BC to Generate events	0-64 ³	0	The total number of BC change event points for monitoring
Binary Counter Object	32-bit +Flag 32-bit -Flag 16-bit +Flag 16-bit -Flag	32-bit -Flag	The default BC object variation for requests with qualifier code 06 when no specific variation is requested

Parameter	Options	Default	Description
Binary Counter Change Event Object	32-bit -Time 32-bit +Time 16-bit -Time 16-bit +Time	32-bit +Time	The default BC change event object variation for requests with qualifier code 06 when no specific variation is requested
Frozen Binary Counter Object	32-bit +Flag 32-bit -Flag 32-bit +Time 16-bit +Flag 16-bit -Flag 16-bit +Time	32-bit -Flag	The default frozen BC object variation for requests with qualifier code 06 when no specific variation is requested
DNP General Options			
16-bit AI Scaling	Disabled Enabled	Enabled	Allows scaling 16-bit analog input objects (see description below)
16-bit BC Scaling	x1, x10, x100, x1000	x1	Allows scaling 16-bit binary counter objects (see description below)
Re-mapping Event Points	Disabled Enabled	Disabled	Allows re-mapping event points starting with point 0.
SBO Timeout ¹	2-30 sec	10	Defines the Select Before Operate (SBO) timeout when using the Control-Relay-Output-Block object
Time Sync Period ²	0-86400 sec	86400	Defines the time interval between periodic time synchronization requests
Multi Fragment Interval	50-500 ms	50	Defines the time interval between fragments of the response message when it is fragmented

¹ The Select Before Operate command causes the device to start a timer. The following Operate command must be sent before the specified timeout value expires.

² The device requests time synchronization by bit 4 in the first octet of the internal indication word being set to 1 when the time interval specified by the Time Sync Period elapses. The master should synchronize the time in the device by sending the Time and Date object to clear this bit. The device does not send time synchronization requests if the Time Sync Period is set to 0.

³ The total number of AI, BI and BC change event points may not exceed 64. **When you change the number of the change event points in the device, all event setpoints are set to defaults** (see Configuring DNP Event Classes below).

Scaling 16-bit AI objects

Scaling 16-bit AI objects allows accommodating native 32-bit analog input readings to 16-bit object format; otherwise it may cause an over-range error if the full-range value exceeds a 16-bit point limit.

Scaling is enabled by default. It is not applied to points that are read using 32-bit AI objects.

Refer to the PM180 DNP3 Reference Guide for information on the data point scales and on a reverse conversion that should be applied to the received scaled values.

Scaling 16-bit Binary Counters

Scaling 16-bit Binary Counters allows changing a counter unit in powers of 10 to accommodate a 32-bit counter value to 16-bit BC object format.

If the scaling unit is greater than 1, the counter value is reported being divided by the selected scaling unit from 10 to 1000. To get the actual value, multiply the counter reading by the scaling unit.

Configuring DNP Class 0

The most common method of getting static object information from the device via DNP is to issue a read Class 0 request. The PM180 allows you to configure the Class 0 response by assigning ranges of points to be polled via Class 0 requests.

To view the factory-set DNP Class 0 assignments or build your own Class 0 response message:

1. From the Meter Setup menu select Protocol Setup and click on the DNP Class 0 Points tab
2. Select the object and variation type for a point range.
3. Specify the start point index and the number of points in the range. Refer to the PM180 DNP3 Reference Guide for available data points.

4. Repeat these steps for all point ranges you want to be included into the Class 0 response.
5. Click Send to download your setup to the device.

The factory-set Class 0 point ranges are shown in the picture below.

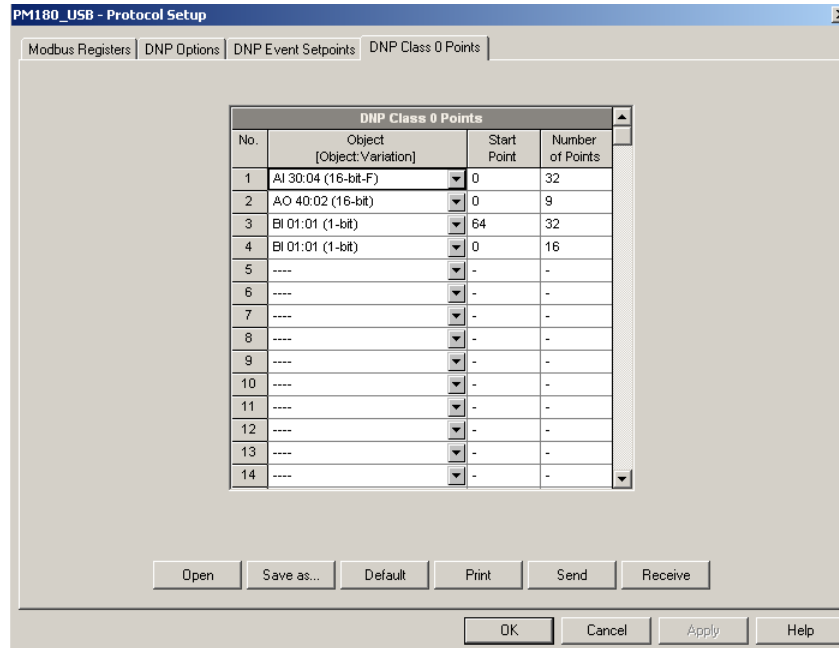

Configuring DNP Event Classes

The PM180 generates object change events for any static analog input, binary input, and binary counter point when a corresponding point either exceeds a predefined threshold, or the point status changes. A total of 64 change event points are available for monitoring.

Object change events are normally polled via DNP Class 1, Class 2 or Class 3 requests. You can link any change event point to any event class upon the event priority. Refer to the PM180 DNP3 Reference Guide for more information on polling event classes via DNP.

A change event point index is normally the same as for the corresponding static object point. To use independent numeration for event points, enable re-mapping event point indices via DNP Options setup (see above) so they start with index 0.

Define a separate event setpoints for each static object point to be monitored for change events. To view or change the factory-set DNP event setpoints, select Protocol Setup from the Meter Setup menu and click on the DNP Event Setpoints tab.

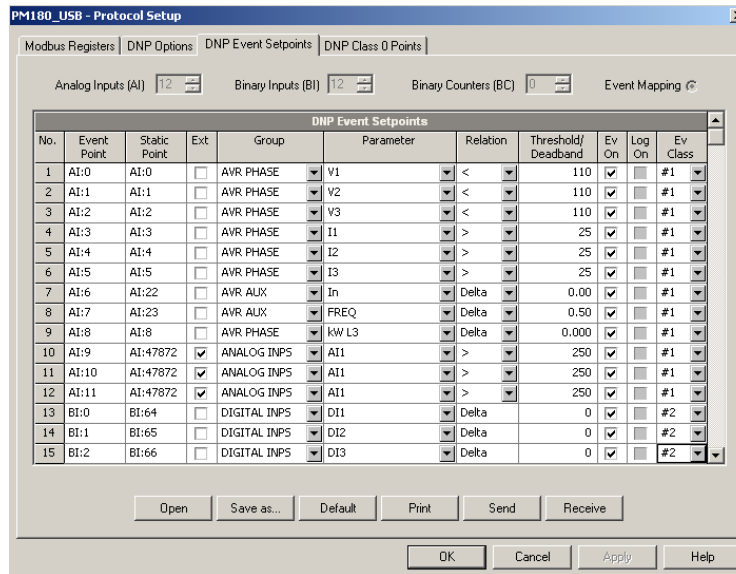

The number of event setpoints for each static object type is specified via the [DNP Options](#) setup.

Note: The device clears all event buffers and links the default set of static points to each event object type every time you change the number of points for any of the objects.

To define setpoints for selected static points:

1. Check the “**Ext**” box if you wish to use the extended point list.
2. Select a parameter group and then a desired parameter for each event point.
3. For AI and BC points, select a relation and an operating threshold or a deadband to be used for detecting events. All thresholds are specified in primary units. The following relations are available:

Delta - a new event is generated when the absolute value of the difference between the last reported point value and its current value exceeds the specified deadband value;

More than (over) - a new event is generated when the point value rises over the specified threshold, and then when it returns below the threshold minus a predefined return hysteresis - applicable for AI objects;

Less than (under) - a new event is generated when the point value drops below the specified threshold, and then when it returns above the threshold plus a predefined return hysteresis - applicable for AI objects.

Hysteresis for the return threshold is 0.05 Hz for frequency and 2% of the operating threshold for all other points.

4. Check the “**Ev On**” box for the points you wish to be included into event poll reports.
5. In the “**Ev Class**” box, select the event poll class for the change event points.
6. Repeat these steps for all points you want to be monitored for events.
7. Click Send to download your setup to the device.

Configuring IEC 60870-5

The PM180 protocol stack is implemented in a very flexible manner. Most of IEC 60870-5-101/104 protocol features are user-configurable allowing easy adaptation for use in different IEC 60870-5 installations. To keep maximum interoperability with master RTU and SCADA systems, the PM180 supports all standard ASDU types for data interrogation, event reporting and control.

The support PAS configuration software supplied with the meter provides all necessary tools for remote configuration of the meter via serial ports or via a TCP/IP Internet connection using either IEC 60870-5-101/104, or Modbus protocol.

For more information see PM180 IEC 60870-5 communication guide.

Configuring IEC 60870-5 Options

To configure the IEC 60870-5 options:

1. Select IEC 60870-5 Setup from the Meter Setup menu.

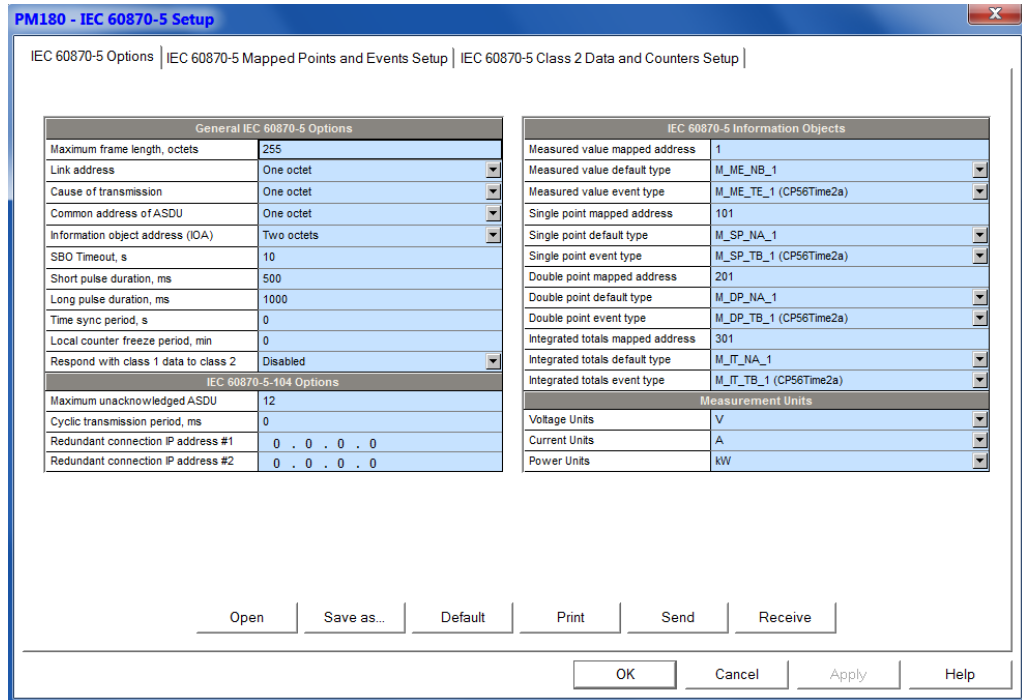

2. Select desired options.
3. Click Save as... to store your setup in the device site database, and click Send to send the setup to the device

See the following table for available options.

Parameter	Options	Default	Description
General IEC 60870-5 Options			
Maximum frame length	32-255 octets	255	The maximum length of the transmission frame. In IEC 60870-5-104 it is fixed to 253 octets.
Link address	1-2 octets	1	Link address length
Cause of transmission	1-2 octets	1	Cause of transmission length. In IEC 60870-5-104 it is fixed to 2 octets.
Common address of ASDU	1-2 octets	1	Length of common address of ASDU. In IEC 60870-5-104 it is fixed to 2 octets.
Information object address	1-3 octets	2	Length of information object address In IEC 60870-5-104 it is fixed to 3 octets.
SBO Timeout, s	0-30 s	10	Select-before-operate (SBO) timeout for single point commands with a select qualifier
Short pulse duration, ms	100-3000 ms	500	Short pulse duration for single point commands with a short pulse qualifier

Parameter	Options	Default	Description
Long pulse duration, ms	100-3000 ms	1000	Long pulse duration for single point commands with a long pulse qualifier
Time sync period, s	1-86400 s, 0=not active	0	The time interval between periodic time synchronization requests
Local counter freeze period, min	1-60 min, 0=not active	0	The period of local counter freeze and spontaneous transmission of integrated totals
Respond with class 1 data to class 2	0=disabled, 1=enabled	Disabled	If enabled, the meter will respond with class 1 data to class 2 requests when there is no class 2 data in transmission
IEC 60870-5-104 Options			
Maximum unacknowledged ASDU	1-32, 0=unlimited	12	The maximum number of unacknowledged ASDU allowed before suspending data transmission. Unlimited when set to 0.
Cyclic transmission period, ms	100-30000 ms, 0=not active	0	The period of cyclic/periodic data transmission via the IEC 60870-5-104 port
Client IP for cyclic transmission	0.0.0.0 =not active	0.0.0.0	The IP address of the controlling station for cyclic/periodic data transmission
Client IP for spontaneous transmission	0.0.0.0 =not active	0.0.0.0	The IP address of the controlling station for spontaneous transmission of events and integrated totals
IEC 60870-5 Information Objects			
Measured value mapped address	1-4095	1	Starting address for mapped static measured value objects
Measured value default type	M_ME_NA_1 M_ME_NB_1 M_ME_NC_1 M_ME_TA_1 M_ME_TB_1 M_ME_TC_1 M_ME_TD_1 M_ME_TE_1 M_ME_TF_1	M_ME_NB_1	The default type of static measured value objects for Read requests
Measured value event type	M_ME_TA_1 M_ME_TB_1 M_ME_TC_1 M_ME_TD_1 M_ME_TE_1 M_ME_TF_1	M_ME_TE_1	The default type of measured value objects for event reporting
Single point mapped address	1-4095	101	Starting address for mapped static single point objects
Single point default type	M_SP_NA_1 M_SP_TA_1 M_SP_TB_1	M_SP_NA_1	The default type of static single point objects for Read requests
Single point event type	M_SP_TA_1 M_SP_TB_1	M_SP_TB_1	The default type of single point objects for event reporting
Double point mapped address	1-4095	201	Starting address for mapped static double point objects

Parameter	Options	Default	Description
Double point default type	M_DP_NA_1 M_DP_TA_1 M_DP_TB_1	M_DP_NA_1	The default type of static double point objects for Read requests
Double point event type	M_DP_TA_1 M_DP_TB_1	M_DP_TB_1	The default type of double point objects for event reporting
Integrated totals mapped address	1-4095	301	Starting address for mapped static integrated totals objects
Integrated totals default type	M_IT_NA_1 M_IT_TA_1 M_IT_TB_1	M_IT_NA_1	The default type of static integrated totals for Read requests
Integrated totals event type	M_IT_TA_1 M_IT_TB_1	M_IT_TB_1	The default type of integrated totals for event reporting
Measurement Units			
Voltage units	0=V, 1=kV	V	Units of voltage measured values
Current units	0=A, 1=kA	A	Units of current measured values
Power units	0=kW, 1=MW	kW	Units of power measured values

NOTES:

1. In IEC 60870-5-104 the maximum length of the variable frame, the common address of ASDU, information object address and cause of transmission length are permanently set to values indicated in the table and the optional settings are ignored.
2. Selecting the one-octet information object address length for IEC 60870-5-101 will limit the range of objects to only mapped points in the range of 1 to 255 and will make impossible configuring IEC 60870-5 in the device via IEC 60870-5-101 ports.

Remapping Point Addresses and Event Reporting

NOTE:

The process measurement scales for most analog values depend on your external PT and CT settings and on the voltage and current scales defined in the meter. Configure them in your meter and save to the device site database before configuring event deadbands. See Basic Setup and Device Options Setup in the EM133 Installation and Operation Manual on how to configure these parameters in the meter.

To remap static object point addresses to the configurable address space and to configure corresponding event objects:

1. Select IEC 60870-5 Setup from the Meter Setup menu, and then click on the IEC 60870-5 Mapped Points and Events Setup tab.

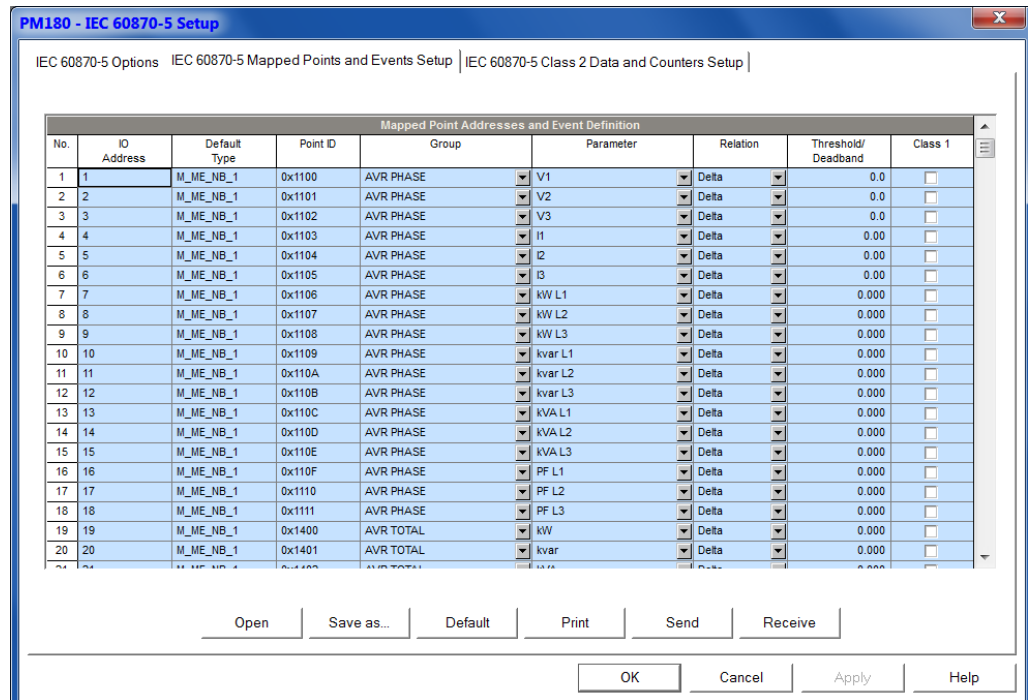

- Select an object group and parameter for points you wish to remap. Object types and addresses are assigned automatically upon the starting mapped address and default static type you selected for the type of objects in the IEC 60870-5 Options Setup. When saving the setup to the device database or sending to the meter all points are automatically arranged in the order: measured values, single point objects, double point objects, integrated totals.
- If you wish to use a static point for reporting events, select a relation and an operating threshold or a deadband to be used for detecting events and check the Class 1 box for the point. The following options are available:

- Delta – a new event is reported when the absolute value of the difference between the last reported point value and its current value exceeds the specified deadband value, or the status of a binary point changes. Measured values with a zero deadband will not be checked for events;
- More than (over) - a new event is reported when the point value rises over the specified threshold, and then when it returns below the threshold minus a predefined return hysteresis – applicable for measured values;
- Less than (under) - a new event is reported when the point value drops below the specified threshold, and then when it returns above the threshold plus a predefined return hysteresis – applicable for measured values.

Hysteresis of the return threshold for measured values is 0.05 Hz for frequency and 2% of the operating threshold for other points.

All thresholds/deadbands for measured values should be specified in primary units.

- Click Save as... to store your setup in the device site database, and click Send to send the setup to the device.

Configuring Class 2 Data and Counter Transmission

This setup allows you to configure object address ranges for interrogation, cyclic/periodic data transmission, and spontaneous counter transmission with or without local freeze/reset.

To configure object address ranges for data transmission:

- Select IEC 60870-5 Setup from the Meter Setup menu, and then click on the IEC 60870-5 Class 2 Data and Counters Setup tab.

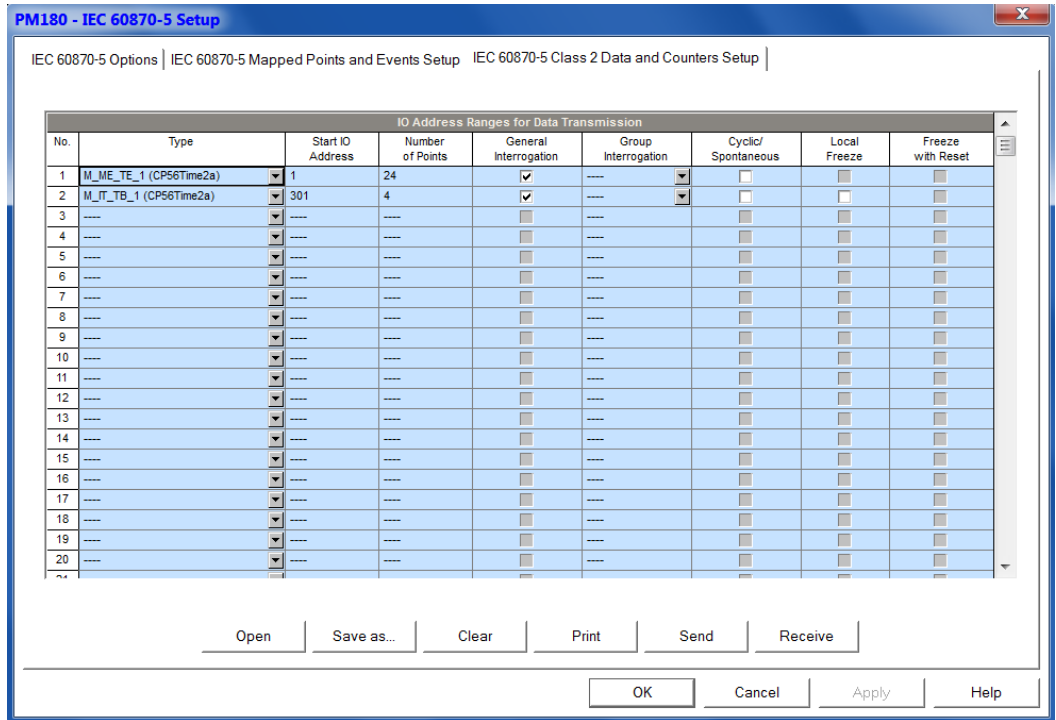

2. Select object type and specify ranges of points to be included into interrogation responses or/and cyclic/spontaneous data transmission. Only mapped point addresses and general object addresses can be used for interrogation and cyclic/spontaneous transmission

Up to 32 address ranges can be selected. Fill rows in succession without gaps. The first blank row will be taken as the end of a range list.

NOTE:

Though double point objects occupy two adjacent addresses, always specify the actual number of requested double points as you define other object ranges.

Class 2 interrogated and cyclic/spontaneous data are always transmitted in the order they are listed in the setup. If you put ranges of point of the same type at continuous rows, they will be packed together and transmitted using minimum number of frames.

3. Check the “General Interrog” box for ranges you wish to include into the general/station interrogation.
4. Select appropriate groups in the “Group Interrog” box for ranges you wish to include into group interrogation. Each range of points can be allocated for both global and group interrogation.
5. Check the “Cyclic/Spont.” box for ranges you wish to include into cyclic/spontaneous data transmission.

Analog and binary data checked for cyclic transmission will be transmitted as cyclic messages. The IEC 60870-5-104 cyclic data transmission period is configurable via the IEC 60870-5 Options setup.

Integrated totals checked for spontaneous transmission will be transmitted as spontaneous messages at configurable local counter freeze/transmission intervals.

6. Check the “Local Freeze” box for A and B modes of transmission of integrated totals with local freeze.

NOTE:

Counters checked for spontaneous transmission without local freeze will be periodically reported at specified counter freeze/transmission intervals either with the frozen counter values if a remote freeze command was issued for counters before (mode D of acquisition of integrated totals), or with the actual counter values for counters that were not frozen.

1. Check the “Freeze with Reset” box for integrated totals for which local freeze with reset should be applied.
2. Click Save as... to store your setup in the device site database, and click Send to send the setup to the device.

Chapter 10 Device Control

This chapter describes how to change device modes, view and clear device diagnostics, and directly operate relay outputs in your PM180 from PAS. To access device control options you should have your device online.

Authorization

If your device is password protected (see [Access Control Menu](#) in Chapter 3 and [Changing the Password and Security](#) in Chapter 3), you are prompted for the password when you send your first command to the device.

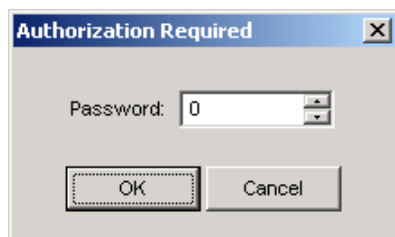

Enter the password and click OK. If your authorization was successful, you are not prompted for the password again until you close the dialog window.

Remote Relay Control

From PAS, you can send a command to any relay in your device or release a latched relay, except of the relays that are linked to the internal pulse source. Such relays cannot be operated outside of the device.

To enter the Remote Relay Control dialog, check the On-line  button on the PAS toolbar, select Device Control from the Monitor menu, and then click on the Remote Relay Control tab.

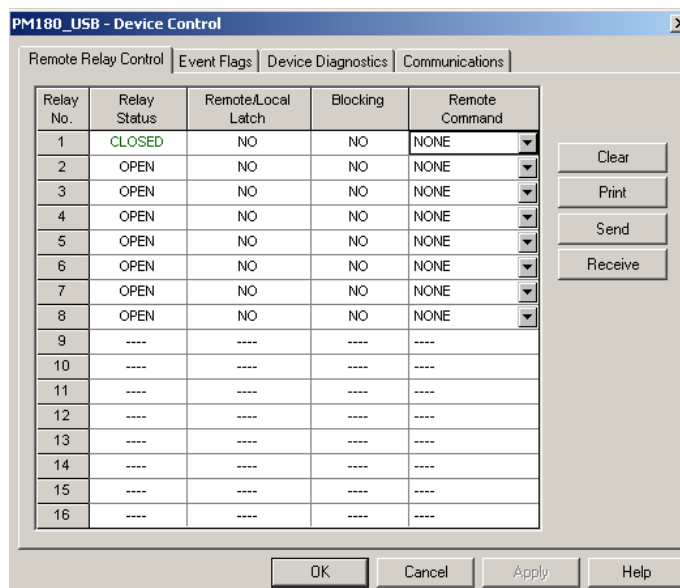

To send a remote command to the relay:

1. From the "Relay Command" box for the relay, select the desired command.
2. Click on Send.

The dialog shows you the present relay status and whether it is latched by a remote command or locally from the setpoints.

Device Event Flags

The PM180 has 16 common event flags that are intended for use as temporary event storage and can be tested and operated from the control setpoints. You can transfer an event to the setpoints and trigger its operation remotely by changing the event status through PAS.

To enter the Event Flags dialog, check the On-line button on the PAS toolbar, select Device Control from the Monitor menu, and then click on the Event Flags tab.

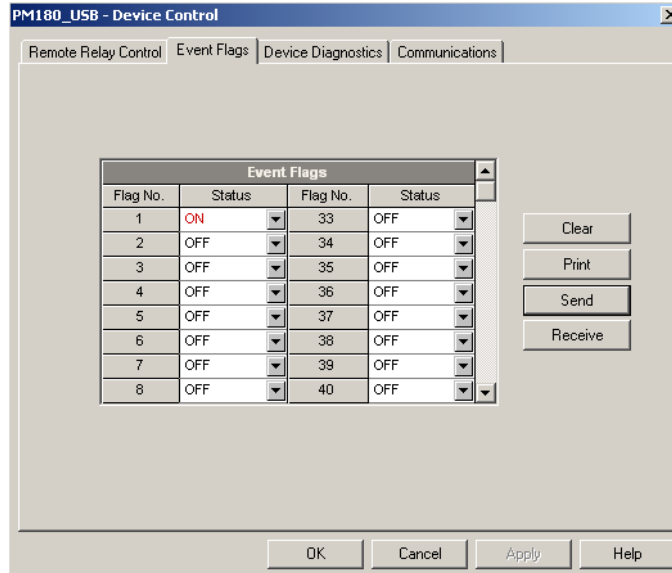

To change the status of an event flag:

1. From the "Status" box for the event flag, select the desired flag status.
2. Click on Send.

Viewing and Clearing Device Diagnostics

You can examine the present device diagnostics status and clear it via PAS.

To enter the Device Diagnostics dialog, check the On-line  button on the PAS toolbar, select Device Control from the Monitor menu, and then click on the Device Diagnostics tab.

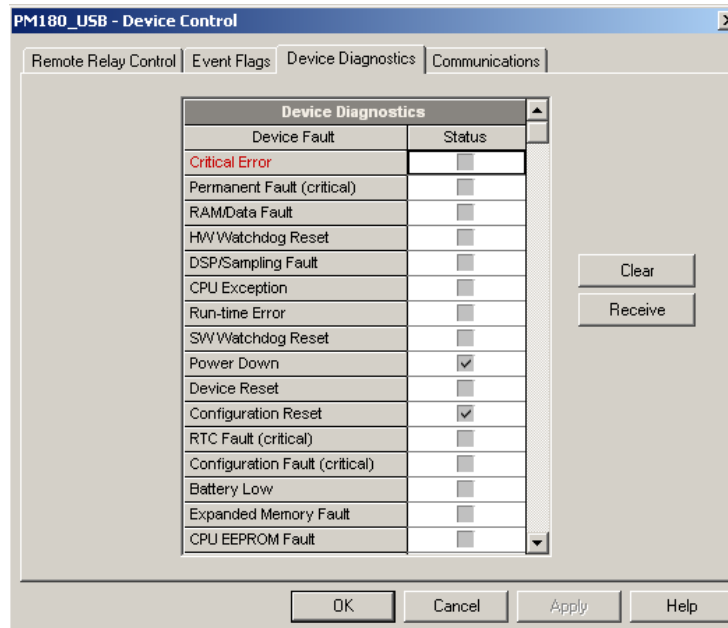

To clear the device diagnostics events, click on Clear.

Refer to [Device Diagnostic Codes](#) in Appendix F for the list of diagnostic codes and their meanings. See [Device Diagnostics](#) in Chapter 3 for more information about device diagnostics.

Updating the Clock

To update the Real-Time Clock (RTC) in your device, select a device site from the list box on the toolbar, check the On-line button  on the PAS toolbar, and then select RTC from the Monitor menu.

The RTC dialog displays the current PC time and the time in your device. To synchronize the device clock with the PC clock, click Set. You need not update the clock in your device if the clock is synchronized to the external GPS master clock.

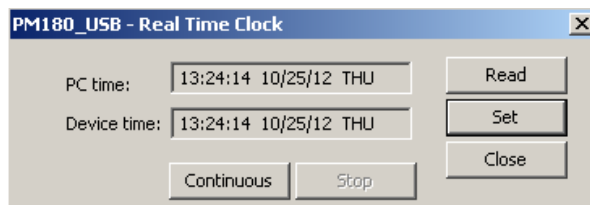

Resetting Accumulators and Clearing Log Files

PAS allows you to clear energy accumulators, maximum demands, Min/Max log registers, counters and log files in your device. To open the Reset dialog, select a device site from the list box on the toolbar, check the On-line button  on the toolbar, and then select Reset from the Monitor menu.

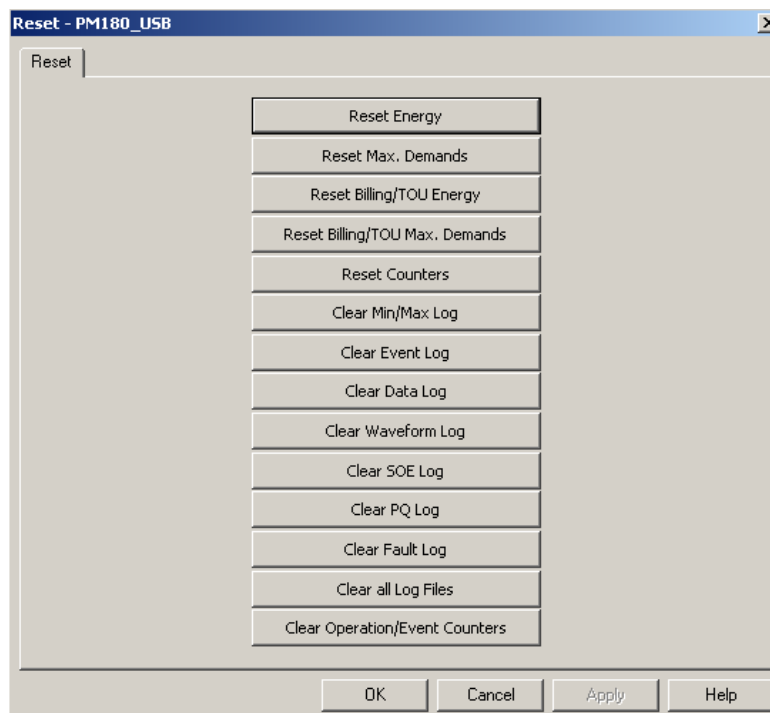

To reset the desired accumulation registers or to clear a file, click on the corresponding button. If a target has more than one component, you are allowed to select components to reset. Check the corresponding boxes, and then click OK.

Upgrading Meter Firmware

You can upgrade device firmware through any communication port installed in your meter: a serial port, USB, Ethernet, a wireless cellular network or a telephone modem.

Downloading firmware is only supported through the Modbus RTU/ASCII and Modbus/TCP protocols. If you are connected to the meter via a serial port, ensure that it operates in Modbus mode. It is also recommended to set the serial port baud rate to 115,200 bps. See [Configuring Communications](#) on how to remotely change the protocol and baud rate in your meter.

To download a firmware file to your meter:

1. Check the On-line button on the PAS toolbar, select Flash Downloader from the Monitor menu, and then confirm changes.

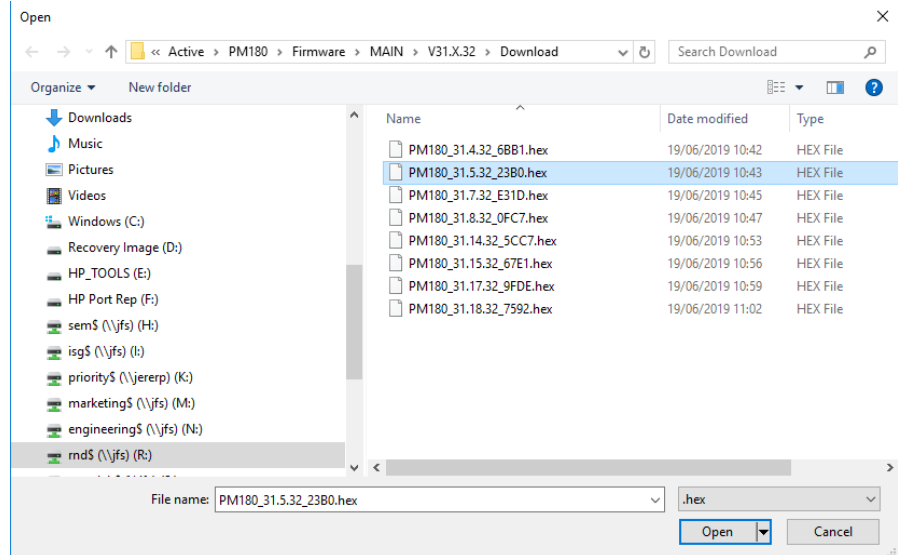

2. Point to the firmware upgrade file, click Open, and then confirm upgrading the meter.
3. When asked for the password, type the meter password, and click OK.

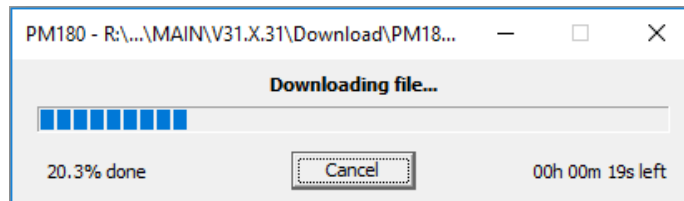

4. Wait until PAS completes downloading the file. It takes about 9-10 minutes at 115,200 bps via a serial port, or about 20 seconds via a USB port, to download the file to the meter.

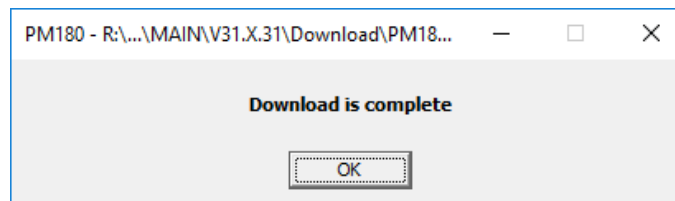

5. Wait about 10 seconds until the meter completes burning firmware into the flash and reboots before any further manipulating with the meter.

NOTES

1. When the meter reboots, the Internet connection via the Ethernet, a telephone or a cellular network may be temporarily lost. You may need to wait a short duration before PAS restores a connection with your meter.
2. If you are connected to the meter via a wireless cellular network using a temporary IP address, the IP address you used for connecting to the meter will no longer be in effect. You should check the meter for a new IP address either from the front display, or via PAS using another communication port.

Chapter 11 Monitoring Devices

Viewing Real-time Data

Real-time data is continuously retrieved from your devices and updated on the screen at the rate you defined in the Instrument Setup.

To get real-time data from your device, select the device site from the list box on the PAS toolbar, point to RT Data Monitor on the Monitor menu, and then select a data set you want to view.

Organizing Data Sets



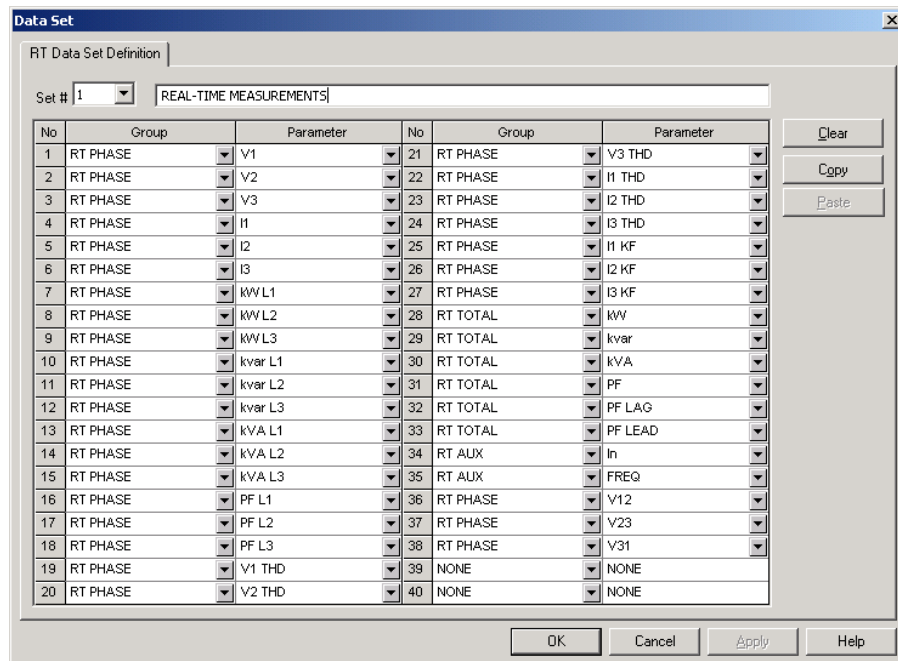

PAS supports 33 programmable data sets with up to 40 data parameters. Set #0 is intended for simple meters, which have a limited number of parameters, and is not recommended for the use with the PM180. To re-organize data sets, select Data Set from the Monitor menu or click on the button  on the local toolbar.



No	Group	Parameter	No	Group	Parameter
1	RT PHASE	V1	21	RT PHASE	V3 THD
2	RT PHASE	V2	22	RT PHASE	I1 THD
3	RT PHASE	V3	23	RT PHASE	I2 THD
4	RT PHASE	I1	24	RT PHASE	I3 THD
5	RT PHASE	I2	25	RT PHASE	I1 KF
6	RT PHASE	I3	26	RT PHASE	I2 KF
7	RT PHASE	kWL1	27	RT PHASE	I3 KF
8	RT PHASE	kWL2	28	RT TOTAL	kV
9	RT PHASE	kWL3	29	RT TOTAL	kvar
10	RT PHASE	kvar L1	30	RT TOTAL	kVA
11	RT PHASE	kvar L2	31	RT TOTAL	PF
12	RT PHASE	kvar L3	32	RT TOTAL	PF LAG
13	RT PHASE	kVA L1	33	RT TOTAL	PF LEAD
14	RT PHASE	kVA L2	34	RT AUX	In
15	RT PHASE	kVA L3	35	RT AUX	FREQ
16	RT PHASE	PF L1	36	RT PHASE	V12
17	RT PHASE	PF L2	37	RT PHASE	V23
18	RT PHASE	PF L3	38	RT PHASE	V31
19	RT PHASE	V1 THD	39	NONE	NONE
20	RT PHASE	V2 THD	40	NONE	NONE

Some data sets are preset for your convenience and others are empty. You can freely modify data sets.

Polling Devices

To run data polling, check the On-line button  on the PAS toolbar, and then click on either the Poll button  or Continuous Poll button  on the local toolbar. Click on the Stop button  to stop continuous polling.

You can open as many data monitor windows as you wish, either for different sites, or for the same site using different data sets.

An open data monitor window is linked to the current site and does not change if you select another site in the site list.

You can view acquired data in a tabular form or in a graphical form as a data trend.

The following picture shows a typical data monitor window.

PM180_USB RT Data Monitor Set #1 - PM180_USB																						
REAL-TIME MEASUREMENTS 10/25/12 13:50:53																						
No.	Date/Time	V1	V2	V3	I1	I2	I3	kW L1	kW L2	kW L3	kvar L1	kvar L2	kvar L3	kVA L1	kVA L2	kVA L3	PF L1	PF L2	PF L3	V1 THD	V2 T	
1	10/25/12 13:50:15	232	232.5	231.4	0.01	0	0	0	0	0	0	0	0	0	0	0	-0.509	0	0	2.4	2	
2	10/25/12 13:50:16	231.9	232.1	232.1	0	0	0	0	0	0	0	0	0	0	0	0	0	0	0	2.3	2	
3	10/25/12 13:50:17	232.4	232.6	232.9	0.01	0	0	0	0	0	0	0	0	0	0	0	-0.214	0	0	2.3	2	
4	10/25/12 13:50:18	233.2	232.5	232.6	0.01	0	0	0	0	0	0	0	0	0	0	0	-0.853	-0.626	-0.444	0	2	
5	10/25/12 13:50:19	232.2	231.6	232.6	0.01	0.01	0	0	0	0	0	0	0	0	0	0	-0.918	-0.422	0	2.4	2	
6	10/25/12 13:50:20	231.2	232	232	0.01	0	0	0	0	0	0	0	0	0	0	0	-0.851	0	0	2.3	2	
7	10/25/12 13:50:21	232.3	232.2	232.2	0.01	0	0	0	0	0	0	0	0	0	0	0	-0.993	0	0	2.2	2	
8	10/25/12 13:50:22	232.3	232.2	232.5	0.01	0	0	0	0	0	0	0	0	0	0	0	0.703	0	0	2.3	2	
9	10/25/12 13:50:23	232.4	232.4	232.1	0.01	0	0	0	0	0	0	0	0	0	0	0	-0.904	0	0	2.3	2	
10	10/25/12 13:50:24	231.3	232.5	232.8	0	0	0	0	0	0	0	0	0	0	0	0	0	0	0	2.3	2	
11	10/25/12 13:50:25	231.7	233.3	232.7	0.01	0.01	0	0	0	0	0	0	0	0	0	0	0.369	-0.647	-0.684	2.3	2	
12	10/25/12 13:50:26	232.1	232.4	232.6	0.01	0	0	0	0	0	0	0	0	0	0.001	0	-0.707	-0.450	-0.546	2.2	2	
13	10/25/12 13:50:27	232.3	232.5	232.2	0.01	0	0	0	0	0	0	0	0	0	0	0	0.936	0	0	2.3	2	
14	10/25/12 13:50:28	233.5	231.8	231.6	0	0	0	0	0	0	0	0	0	0	0	0	-0.978	0	0	2.2	2	
15	10/25/12 13:50:29	232.4	231.7	231.7	0.01	0	0	0	0	0	0	0	0	0	0	0	0.995	0	0	2.2	2	
16	10/25/12 13:50:30	231.6	232.3	232.4	0.01	0	0	0	0	0	0	0	0	0	0	0	-0.988	0	0	2.2	2	
17	10/25/12 13:50:31	232.3	232	232.5	0	0	0	0	0	0	0	0	0	0	0	0	-0.354	0	0	2.1	2	
18	10/25/12 13:50:32	232.3	232.3	232.1	0.01	0	0	0	0	0	0	0	0	0	0	0	0.549	0	0	2.2	2	
19	10/25/12 13:50:33	232.1	232.8	233.3	0.01	0	0	0	0	0	0	0	0	0	0	0	-0.715	0	0	2.2	2	
20	10/25/12 13:50:34	231.7	231.6	231.6	0.01	0	0	0	0	0	0	0	0	0	0	0	-0.110	0	0	2.2	2	
21	10/25/12 13:50:35	231.5	231.8	232.1	0.01	0	0	0	0	0	0	0	0	0	0	0	0.161	0	0	2.2	2	
22	10/25/12 13:50:36	232.1	232	232.2	0.01	0	0	0	0	0	0	0	0	0	0	0	0.817	0	0	2.1	2	
23	10/25/12 13:50:37	231.4	231.9	232.2	0.01	0.01	0.01	0	0	0	0	0	0	0	0	0	0.954	-0.757	-0.870	2.2	2	
24	10/25/12 13:50:38	231.7	232.2	232.3	0.01	0	0	0	0	0	0	0	0	0	0	0	-0.483	0	0	2.2	2	
25	10/25/12 13:50:39	232.5	231.6	231.8	0.01	0	0	0	0	0	0	0	0	0	0	0	0.822	0	0	2.1	2	
26	10/25/12 13:50:40	232.7	232.1	232	0.01	0	0	0	0	0	0	0	0	0	0	0	0	0.846	0	0	2.2	2
27	10/25/12 13:50:41	232.2	232.4	232.2	0.01	0.01	0	0	0	0	0	0	0	0	0.001	0	0.885	-0.954	-0.995	2	2	
28	10/25/12 13:50:42	232.6	231.9	232.1	0	0	0	0	0	0	0	0	0	0	0	0	0	0	0	2.2	2	
29	10/25/12 13:50:43	232.1	232.3	233.2	0.01	0	0	0	0	0	0	0	0	0	0	0	-0.926	0	0	2.1	2	
30	10/25/12 13:50:44	232.8	232	232.4	0.01	0	0	0	0	0	0	0	0	0	0	0	-0.932	0	0	2.2	2	
31	10/25/12 13:50:45	232.7	233.1	232.2	0.01	0	0	0	0	0	0	0	0	0	0	0	-0.519	0	0	2.2	2	
32	10/25/12 13:50:46	232.1	232.4	232.5	0.01	0	0	0	0	0	0	0	0	0	0	0	-0.997	0	0	2.2	2	
33	10/25/12 13:50:47	232.9	231.7	232.6	0.01	0	0	0	0	0	0	0	0	0	0	0	-0.705	-0.206	0	2.3	2	
34	10/25/12 13:50:48	232.1	231.7	232.2	0.01	0	0	0	0	0	0	0	0	0	0	0	0.892	0	0	2.3	2	
35	10/25/12 13:50:49	232.7	232.8	232.1	0.01	0	0	0	0	0	0	0	0	0	0	0	-0.893	0	0	2.3	2	
36	10/25/12 13:50:50	232	232.7	232	0.01	0.01	0	0	0	0	0	0	0	0	0	0	-0.986	-0.907	0	2.3	2	
37	10/25/12 13:50:51	232.8	232.4	231.9	0.01	0	0	0	0	0	0	0	0	0	0	0	0.602	0	0	2.3	2	
38	10/25/12 13:50:52	231.7	232.4	232.4	0.01	0	0	0	0	0	0	0	0	0	0	0	0.217	0	0	2.3	2	
39	10/25/12 13:50:53	232.3	234	233	0.01	0	0	0	0	0	0	0	0	0	0	0	0.987	0	0	2.3	2	

Polling Options

To change the polling options, click on the Data Monitor window with the right mouse button and select Options.

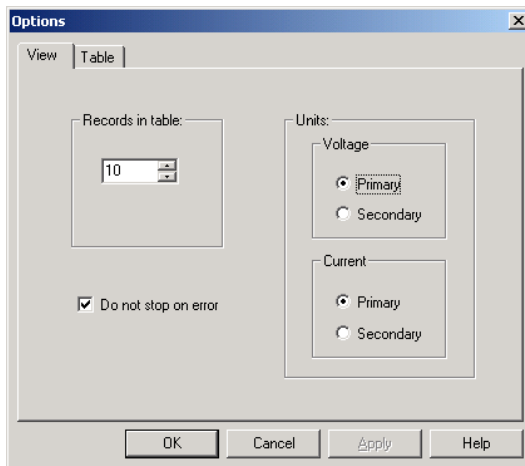

If you check “Do not stop on errors”, polling is resumed automatically when a communication error occurs, otherwise polling stops until you restart it manually.

Viewing a Data Table

Changing the Data View

PAS displays data in either a single record or multi-record view. To change the view, click on the Data Monitor window with the right mouse button and select either Wrap to see a single record, or UnWrap to go to the multi-record view.



Adjusting the Number of Rows in a Multi-Record View

Click the window with the right mouse button, select Options, adjust the number of records you want to see in the window, and then click OK. When the number of retrieved records exceeds the number of rows in the window, the window scrolls up so that older records are erased.

Selecting Primary and Secondary Units

Voltages and currents can be displayed in primary or secondary units. To select primary or secondary units for your data views, click on the monitor window with the right mouse button, select Options, select the desired units for voltages and currents, and then click OK.

Viewing Data Trend

To view a data trend, click on the  button on the local toolbar. To change the time range for your graph, click on the  button on the local toolbar, and then select the desired date and time range.

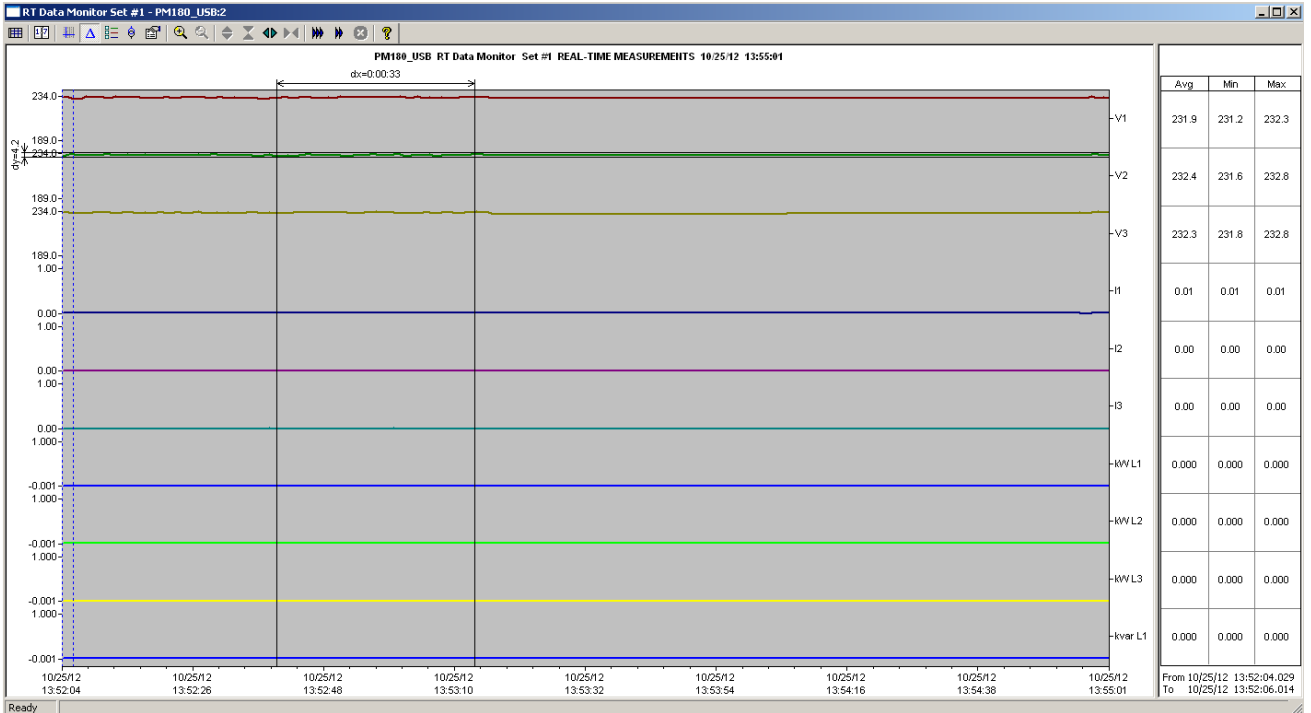

Selecting Channels

To select data channels for your trend, click on the trend window with the right mouse button, select “Channels”, check the channels you want displayed, and then click OK.

Customizing Line Colors and Styles

Trend lines for different channels can be shown in different colors using different line styles. To change the colors or line styles, click on the trend window with the right mouse button, select “Options...”, click on the “Display” tab, adjust colors and styles for channels, and then click OK. You can also change the colors for the background and gridlines.

Using the Marker Lines

The trend window has two blue dashed marker lines. The left marker indicates the starting position for calculating the average and peak values, and the right marker indicates the end position.



To change the marker position, click on the trend window with the right mouse button and select Set Marker, or click on the  button on the window toolbar, and then click with left mouse button on the point where you want to put the marker. You can also drag both markers with the mouse, or use the right and left arrow keys on your keyboard to change the marker position. Click on the trend pane with the mouse before using the keyboard, to allow the keyboard to get your input.

Delta Measurements

To measure the distance between two trend points, click on the Delta button  on the toolbar, click with the left mouse button on the first point, and then click on the second point. The first reference point is frozen until you close and reopen Delta, while the second point can be placed

anywhere within the trend line. You can measure a delta in both directions. To disable Delta, click on the Delta button again.

Using a Zoom

You can use a horizontal and a vertical zoom to change size of your graph. Use the buttons  on your local toolbar representing green arrowheads to zoom in or out of the trend graph. Every click on these buttons gives you a 100-percent horizontal zoom. Two buttons  representing a magnifying glass give you a proportional zoom in both directions.

Saving Data to a File



To save retrieved data to a file for later analysis, click on the Save button , select a directory where you want your log files to be stored, select a database or type the name for a new database, and then click Save. To avoid confusion, do not store data files into the "Sites" directory where site databases are located.

Printing Data

To print retrieved data, click the  button on the PAS toolbar, select a printer, and then click OK. To check the report, as it will look when printed, select Print Preview from the File menu.

Copying Data

To copy the entire data table or a part of a table into the Clipboard or into another application such as Microsoft Excel or Word:

1. Click on the Data Monitor window with the right mouse button and choose Select All, or click on the upper-left corner of the data table (where the "No." label is displayed).
2. Click on the Data Monitor window with the right mouse button again and choose Copy or click on the Copy button  on the PAS toolbar.
3. Run an application to where you want to copy data, position cursor at the correct place, and then click on the Paste button , or select Paste from the Edit menu.

If you want only a part of data to be copied, select with the mouse while holding the left mouse button the rows or columns in the table you want to copy, and then click on the Copy button  on the PAS toolbar.

Real-time Data Logging

PAS allows you to log polled data records to a database automatically at the time it updates the Data Monitor window on the screen.

To setup the real-time logging options:



1. Open the Data Monitor window.
2. Click on the "RT Logging On/Off"  button on the local toolbar, or select "RT Logging Options" from the Tools menu.
3. Select a database, or type the name for a new database and select a directory where you want to save it.
4. Select the number of tables, and the number of records in each table you want recorded.
5. Adjust the file update rate for automatic recording. It must be a multiple of the sampling rate that you defined in the Instrument Setup dialog.
6. Click Save.

When you run real-time data polling, PAS automatically saves retrieved records to the database at the rate you specified. The "RT Logging On/Off" button  on the toolbar should be checked all the time to allow PAS to perform logging. You can suspend logging by un-checking this button, and then resume logging by checking it again.

Viewing Real-time Min/Max Log

To retrieve the real-time Min/Max log data from your device, select the device site from the list box on the PAS toolbar, point to RT Min/Max Log on the Monitor menu, and then select a data set you want to view.





PAS supports nine programmable data sets with up to 40 data parameters in each one. To reorganize data sets, select Data Set from the Monitor menu or click on the  button on the toolbar. You can modify data sets in the way that is convenient for your use.

To retrieve the selected Min/Max log data, check the On-line button  on the PAS toolbar, and then click on the Poll button .

You can save retrieved data to a file or print it in the same manner as described in the previous section.

Viewing Real-time Waveforms

To retrieve the real-time waveforms from your device, select the device site from the list box on the toolbar, and then select RT Waveform Monitor from the Monitor menu.

To retrieve waveforms, check the On-line button  on the PAS toolbar, and then click on either the Poll button  or Continuous poll button . Click on the Stop button  to stop continuous polling.

PAS normally retrieves eight 4-cycle AC waveforms (V1-V4 and I1-I4) sampled at a rate of 128 samples per cycle. If you wish to get only waveforms for selected phases, select "Options" from the Tools menu, click on the Preferences tab, check the phases you want polled, and then click OK.

To view AI waveforms, or to change channels displayed in the window, click on the waveform window with the right mouse button, select "Channels", check channels you want displayed, and then click OK.

Retrieved waveforms can be displayed in different views as overlapped or non-overlapped waveforms, as RMS cycle-by-cycle plot, or as a harmonic spectrum chart or table. See [Viewing Waveforms](#) in Chapter 13 for information on using different waveform views.

Chapter 12 Retrieving Recorded Files

Using PAS, you can retrieve recorded events, data and waveforms from your devices and save them to files on your PC in the MS Access database format.

Historical data can be uploaded on demand any time you need it, or periodically through the Upload Scheduler that retrieves data automatically on a predefined schedule, for example, daily, weekly or monthly. If you do not change the destination database location, the new data is added to the same database so you can store long-term data profiles in one database regardless of the upload schedule you selected.

Uploading Files on Demand

To retrieve the log files from your device:

1. Select a device site from the list box on the PAS toolbar.
2. Check the On-line button .
3. Select Upload Logs from the Logs menu.

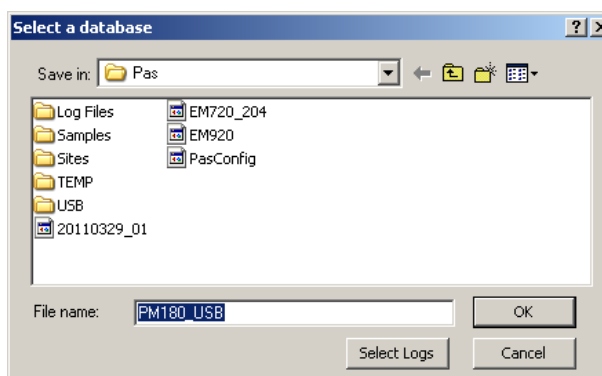

4. Select a database, or type the name for a new database, and select a directory where you want to save it.
5. Click on the “Select Logs” button and check boxes for logs you want to be retrieved from the device.

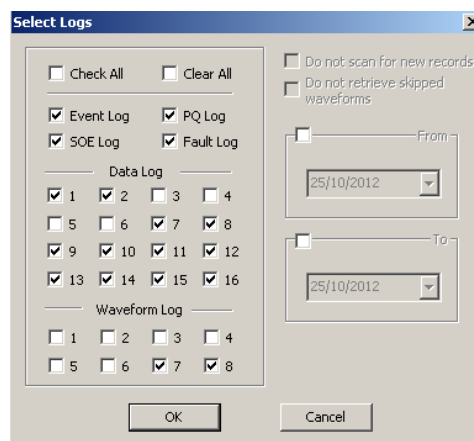

6. If you wish to retrieve data starting with a known date, check the “From” box and select the start date for retrieving data.
7. If you wish to retrieve data recorded before a known date, check the “To” box and select the last date for retrieving data.
8. Click OK.

Using the Upload Scheduler

To setup the Upload Scheduler:

1. Select Upload Scheduler from the Logs menu.

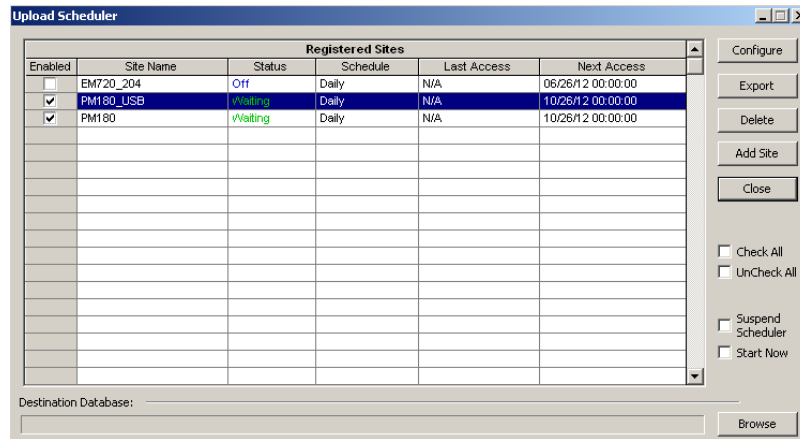

2. Click Add Site, point to the site database for which you want to organize the schedule, and then click OK.
3. Click Browse and select a database for storing retrieved data, or type the name for a new database, select a directory where you want to save it, and then click OK.
4. Click Configure or double click on the site row.

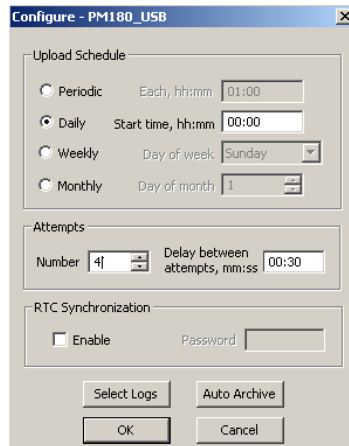

5. Select a daily, weekly or monthly schedule, and adjust the start time. If you wish to upload data periodically in predefined intervals, click on "Periodic" and define the time period in hours and minutes.
6. Select the number of attempts to upload data in the event of temporary communication problems or unavailability of your device, and the delay between attempts in minutes and seconds.
7. If you wish to use the schedule to synchronize the device clock with your PC, check the "RTC Synchronization Enable" box. If your device is password protected by a communications password, type in the password you set in the device to allow PAS to update the clock.
8. Click on the Select Logs button, check the boxes for logs you want to upload on a schedule, and then click OK.
9. Check the Enabled box at left to activate a schedule for the device.
10. Click OK to store your schedule.

To keep the Upload Scheduler running, the On-line button  on the PAS toolbar must be checked all the time. If you uncheck it, the scheduler stops operations. This does not cause loss of data, since the scheduler will resume operations when you check this button again.

Suspending the Scheduler

To suspend the Upload Scheduler, check the Suspend Scheduler box at right. To activate the Upload Scheduler, leave this box unchecked.

Running the Scheduler on Demand

You can run the scheduler at any time outside the schedule by checking the Start Now box at right. This is a one-time action. After uploading is completed, the Upload Scheduler un-checks this box automatically.

Reviewing Upload Problems

When the Upload Scheduler fails to retrieve data from the device, or some data is missing, or another problem occurs, it puts an error message to the log file. To review this file, select System Log from the View menu.

Retrieving EN50160 Statistics Files

The EN50160 statistics files and present contents of the EN50160 evaluation counters can be retrieved by PAS and stored to a database for later analysis.

Using the Upload Scheduler

The PAS Upload Scheduler automatically retrieves the EN50160 statistics files on a daily or weekly basis depending on the EN50160 evaluation period selected in your device.

Select the Daily or Weekly schedule for the EN50160 statistics files when configuring the upload schedule (see [Using the Upload Scheduler](#)). Check the Data log #9 and #10 boxes in the Select Logs dialog box for uploading the EN50160 Compliance Statistics and EN50160 Harmonics Survey files respectively.

Retrieving EN50160 Statistics Files on Demand

To manually retrieve the EN50160 statistics files on demand, select "Upload EN50160 Compliance Stats" from the Logs menu and specify the database to which you want the data to be stored.





Retrieving the EN50160 Online Statistics

To retrieve the present contents of the EN50160 statistics counters accumulated since the beginning of the current evaluation period, select "Upload EN50160 Online Stats" from the Logs menu and specify the database to which you want the data to be stored. The statistics records are marked as online events.

See [Viewing the EN50160 Online Statistics Report](#) for information on how to get the EN50160 compliance report for the latest online statistics stored in the database.

Viewing Historical Data On-line

Sometimes, it is useful to review a particular piece of historical data on-line at the time you expect new events to appear in the log. PAS allows you to retrieve historical data from a particular log without storing it to a file. The data appears only in the window on your screen. You can save it manually to the database.

To view the log data on-line, check the On-line button  on the PAS toolbar, select the log you want to retrieve in the Logs menu, and then click on the Poll button . Only new log records are retrieved from the device. If you want to review the entire log from the beginning, click on the Restore log button , and then click on the Poll button .

Notice that there is a difference between retrieving waveforms on-line and viewing waveforms from a file. The online waveforms are read one record a time, so that a multi-record waveform series may not be viewed as a single waveform.

See Chapter 13, [Viewing Log Files](#), for information on using different log views.

Chapter 13 Viewing Log Files



General Operations

Opening a Log File

To open a log file, click on the Open button  on the PAS toolbar, or select "Open..." from the File menu. In the "Files of type" box, select "Access Database (*.mdb)", select a directory where your files are located, point to the file you want to open, select a desired table on the right pane, and then click Open.

Copying Data

To copy the entire data table or graph, or part of the data, into the Clipboard or into another application such as Microsoft Excel or Word:

1. Click on the data window with the right mouse button and choose Select All, or, if your current view represents a table, click on the upper-left corner of the table (where the "No." label is commonly displayed).
2. Click with the right mouse button on the window again and choose Copy, or click on the Copy button  on the PAS toolbar.
3. Run the application to which you want to copy data, position the cursor at the correct place, and then click the Paste button  on the application's toolbar or select Paste from the Edit menu.

Saving Data to a File

To save data to a file, click on the Save button , select a directory where you want your log file to be stored, select a database or type the name for a new database, and then click Save. To avoid confusion, do not store data files into the "Sites" directory where site databases are located.

Printing Reports

To print a data report to a printer, click on the print button  on the toolbar, select a printer and click OK. If you want to check how your document appears on the printed page, select Print Preview from the File menu.

Customizing Views

Date Order

To change the way PAS displays the date, select Options from the Tools menu, click on the Preferences tab, select the preferred date order, and then click OK.

Timestamp

The timestamp is normally recorded and displayed on the screen at a 1-ms resolution. If you have an application that does not support this format, you may instruct PAS to drop the milliseconds. To change the way PAS records and displays the timestamp, select Options from the Tools menu, click on the Preferences tab, select the preferred timestamp format, and then click OK.

Voltage Disturbance Units

When programming a voltage disturbance trigger in your device, the operate limit for the trigger can be set either in a percent of the nominal voltage, or in voltage RMS units. To change the disturbance units, select Options from the Tools menu, click on the Preferences tab, select the preferred units, and then click OK.

Viewing the Event Log

Event log files are displayed in a tabular view, one event per row. PAS loads the entire database table to a window, so that you can scroll through the entire log to view its contents.

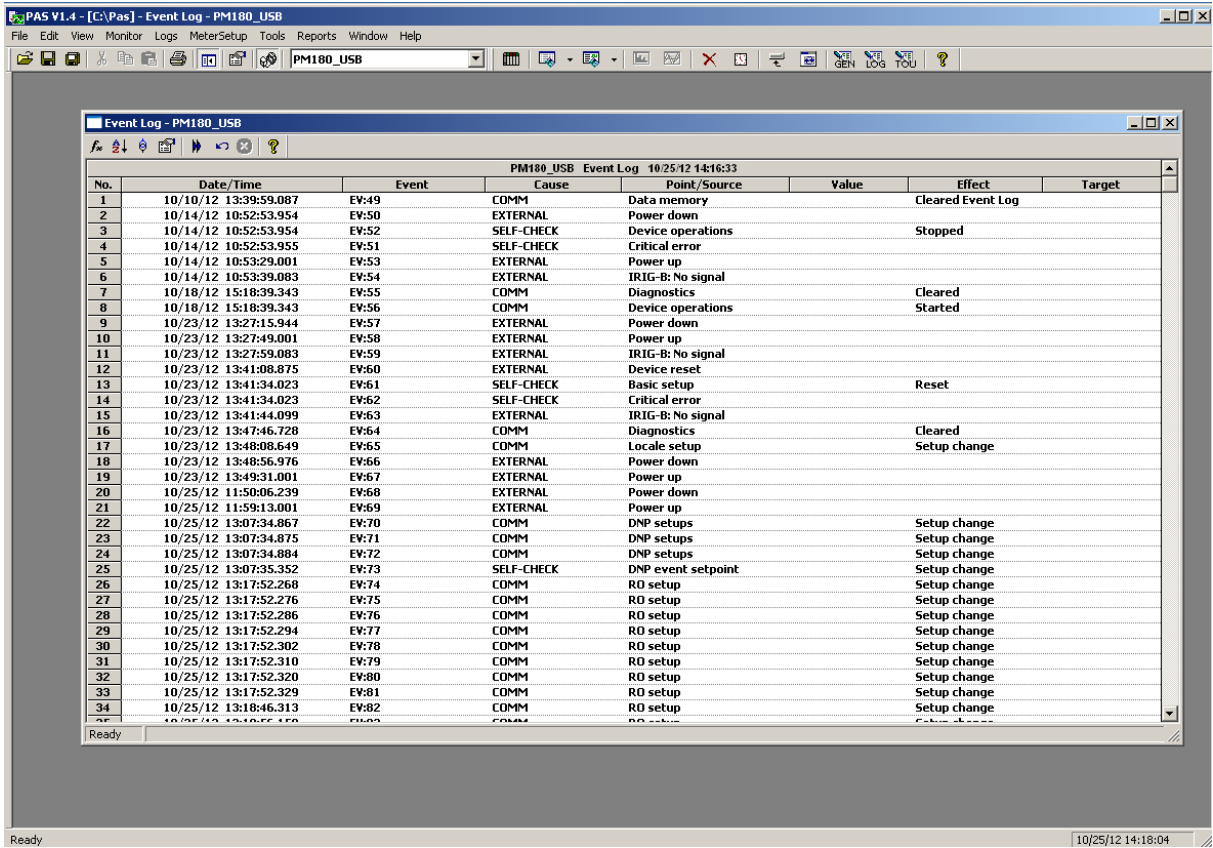

Selecting Primary and Secondary Units

Voltages and currents can be displayed in primary or secondary units. To select units for your data views, click on the monitor window with the right mouse button, select Options, select the desired units for voltages and currents, and then click OK.

Filtering and Sorting Events

You can use filtering to find and work with a subset of events that meet the criteria you specify. Click on the Filter button , or click on the report window with the right mouse button and select "Filter...". Check the causes of events you want to display, and then click OK. PAS temporarily hides rows you do not want displayed.

To change the default sorting order based on the date and time, click on the Sort button , or click on the report window with the right mouse button and select "Sort...", check the desired sort order, and then click OK.

Linking to Waveforms and Data Records

If you programmed a setpoints to log setpoints operations to the Event log and the setpoints can trigger the Waveform or Data recorder, PAS automatically establishes links between the event and other database records where it finds a relationship with the event. Waveforms recorded at the time of the event are always linked to this event, even if the waveform was triggered by another source.

The event ID for which PAS finds related data is blue colored. Click on the colored event ID to check a list of the event links. Click on a list item to move to the related waveform or data log record.

Viewing the IEC 61000-4-30 Profile log file

IEC 61000-4-30 Profile log file is displayed in a tabular view, one 10 minutes time per row. PAS loads the first section entire database table to a window – the IEC 61000-4-30 RMS-Power Profile only, a total of 105 parameters per row, so that you can scroll through the entire log to view its contents.

No.	Date/Time	Event	V1	V1 MAX	V1 MIN	V2	V2 MAX	V2 MIN	V3	V3 MAX	V3 MIN	V4	V4 MAX	V4 MIN	V12	V12 MAX	V12 MIN	V23	V23 MAX	V23 MIN	V31	V31 MAX		
1	16-04-19 11:40:00.000		0.0	0.0	0.0	0.0	0.0	0.0	0.0	0.0	0.0	0.0	0.0	0.0	0.0	0.0	0.0	0.0	0.0	0.0	0.0	0.0	0.0	
2	16-04-19 11:50:00.000		0.0	0.0	0.0	0.0	0.0	0.0	0.0	0.0	0.0	0.0	0.0	0.0	0.0	0.0	0.0	0.0	0.0	0.0	0.0	0.0	0.0	0.0
3	16-04-19 12:00:00.000		0.0	0.0	0.0	0.0	0.0	0.0	0.0	0.0	0.0	0.0	0.0	0.0	0.0	0.0	0.0	0.0	0.0	0.0	0.0	0.0	0.0	0.0
4	16-04-19 12:10:00.000		0.0	0.0	0.0	0.0	0.0	0.0	0.0	0.0	0.0	0.0	0.0	0.0	0.0	0.0	0.0	0.0	0.0	0.0	0.0	0.0	0.0	0.0
5	16-04-19 12:20:00.000		0.0	0.0	0.0	0.0	0.0	0.0	0.0	0.0	0.0	0.0	0.0	0.0	0.0	0.0	0.0	0.0	0.0	0.0	0.0	0.0	0.0	0.0
6	16-04-19 12:30:00.000		0.0	0.0	0.0	0.0	0.0	0.0	0.0	0.0	0.0	0.0	0.0	0.0	0.0	0.0	0.0	0.0	0.0	0.0	0.0	0.0	0.0	0.0
7	16-04-19 12:40:00.000		0.0	0.0	0.0	0.0	0.0	0.0	0.0	0.0	0.0	0.0	0.0	0.0	0.0	0.0	0.0	0.0	0.0	0.0	0.0	0.0	0.0	0.0
8	16-04-19 12:50:00.000		0.0	0.0	0.0	0.0	0.0	0.0	0.0	0.0	0.0	0.0	0.0	0.0	0.0	0.0	0.0	0.0	0.0	0.0	0.0	0.0	0.0	0.0
9	16-04-19 13:00:00.000		0.0	0.0	0.0	0.0	0.0	0.0	0.0	0.0	0.0	0.0	0.0	0.0	0.0	0.0	0.0	0.0	0.0	0.0	0.0	0.0	0.0	0.0
10	16-04-19 13:10:00.000		0.0	0.0	0.0	0.0	0.0	0.0	0.0	0.0	0.0	0.0	0.0	0.0	0.0	0.0	0.0	0.0	0.0	0.0	0.0	0.0	0.0	0.0
11	16-04-19 13:20:00.000		0.0	0.0	0.0	0.0	0.0	0.0	0.0	0.0	0.0	0.0	0.0	0.0	0.0	0.0	0.0	0.0	0.0	0.0	0.0	0.0	0.0	0.0
12	16-04-19 13:30:00.000		0.0	0.0	0.0	0.0	0.0	0.0	0.0	0.0	0.0	0.0	0.0	0.0	0.0	0.0	0.0	0.0	0.0	0.0	0.0	0.0	0.0	0.0
13	16-04-19 13:40:00.000		0.0	0.0	0.0	0.0	0.0	0.0	0.0	0.0	0.0	0.0	0.0	0.0	0.0	0.0	0.0	0.0	0.0	0.0	0.0	0.0	0.0	0.0
14	16-04-19 13:50:00.000		0.0	0.0	0.0	0.0	0.0	0.0	0.0	0.0	0.0	0.0	0.0	0.0	0.0	0.0	0.0	0.0	0.0	0.0	0.0	0.0	0.0	0.0

The remaining sections can only be viewed using [retrieving recorders files process](#).

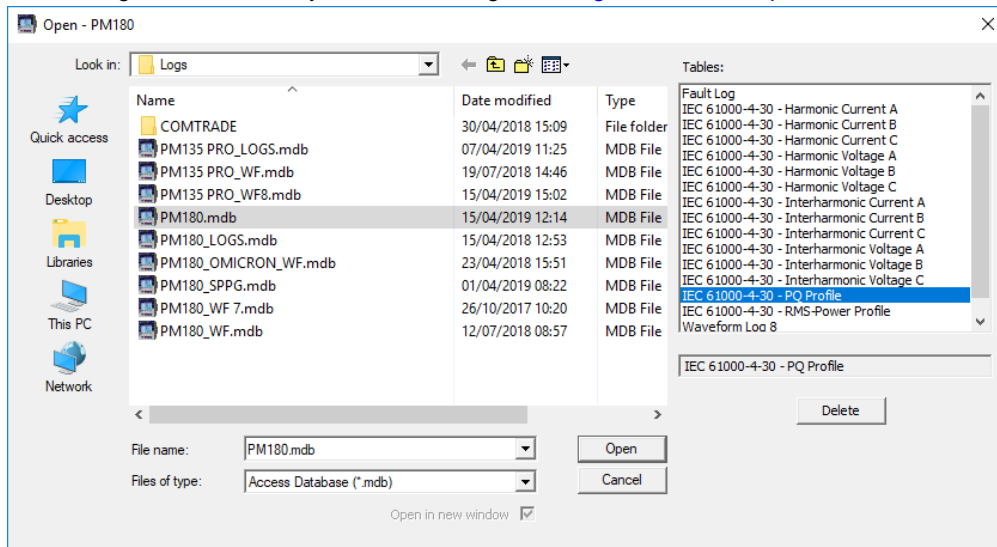

Viewing the Sequence-of-Events Log

SOE log files are displayed in a tabular view, one event per row. You can make your SOE reports more informative by providing extended event point identification and status descriptions (see [Adding Point and Status Labels to the SOE Log](#)).

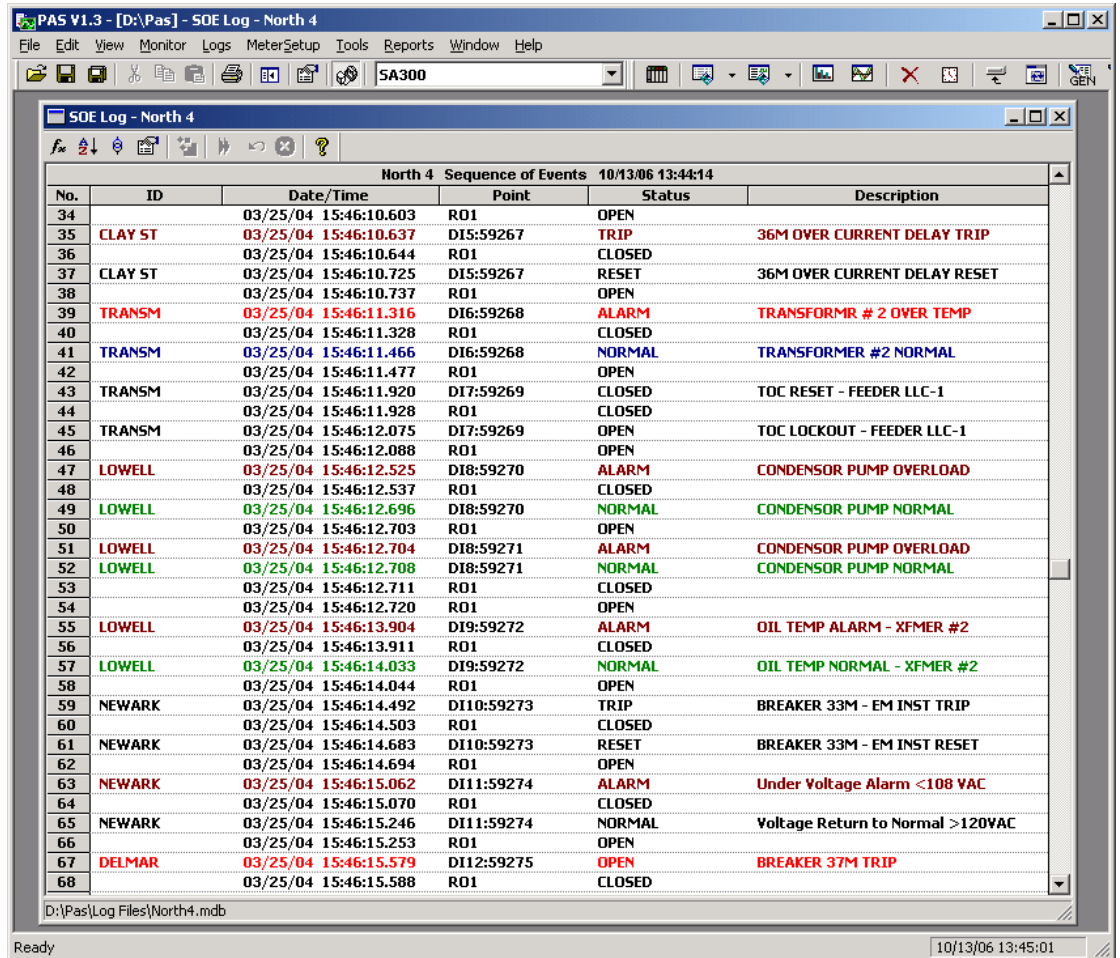

Notice that events marked with an asterisk have a timestamp synchronized at one millisecond with the satellite GPS clock.

Filtering and Sorting Events

To filter events, click on the Filter button , or click on the report window with the right mouse button and select "Filter...", check the event source points you want to display, and then click OK.

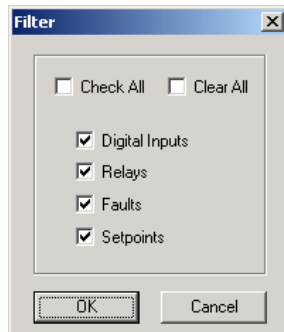

To change the event sorting order, click on the Sort button , or click on the report window with the right mouse button and select "Sort...", check the desired sort order, and then click OK.

Linking to Waveforms, Fault Log and Data Records

Event points, for which PAS finds related data in other database records, are blue colored. Click on the colored event point with the left mouse button to check a list of the event links. Click on a list item to move to the related waveform or fault log record.

Viewing the Power Quality Event Log

IEEE 1159 and EN 50160 PQ log files are displayed in a tabular view, one event per row. The IEEE 1159 PQ log normally contains both power quality and fault events. By default, the fault events are not displayed in the PQ report unless you enable them through the event filter (see below).

No.	Date/Time	Event	Fault Category	Phase	Fault Magnitude	PU	Duration
1	10/14/12 10:53:39.435	PQE7:9	Temporary overvoltage	V1	244.3	6.46	218:33:35.878190
2	10/14/12 10:53:39.435	PQE7:9	Temporary overvoltage	V2	244.3	6.46	218:33:35.878190
3	10/14/12 10:53:39.435	PQE7:9	Temporary overvoltage	V3	244.3	6.46	218:33:35.878190
4	10/14/12 14:50:01.000	PQE4:10	Flicker severity	V1 Plt	20		214:37:14.000000
5	10/14/12 14:50:01.000	PQE4:10	Flicker severity	V2 Plt	20		214:37:14.000000
6	10/14/12 14:50:01.000	PQE4:10	Flicker severity	V3 Plt	20		214:37:14.000000
7	10/23/12 13:27:15.314	PQE5:11	Voltage dip	V1	0	0.00	0:00:00.040015
8	10/23/12 13:27:15.314	PQE5:11	Voltage dip	V2	0	0.00	0:00:00.040015
9	10/23/12 13:27:15.314	PQE5:11	Voltage dip	V3	1.1	0.03	0:00:00.040015
10	10/23/12 13:41:44.467	PQE7:14	Temporary overvoltage	V1	234.1	6.19	0:07:12.031614
11	10/23/12 13:41:44.467	PQE7:14	Temporary overvoltage	V2	234.2	6.20	0:07:12.031614
12	10/23/12 13:41:44.467	PQE7:14	Temporary overvoltage	V3	233.9	6.19	0:07:12.031614
13	10/23/12 13:48:56.499	PQE5:15	Voltage dip	V1	1	0.03	0:00:00.380108
14	10/23/12 13:48:56.499	PQE5:15	Voltage dip	V2	1	0.03	0:00:00.380108
15	10/23/12 13:48:56.499	PQE5:15	Voltage dip	V3	0	0.00	0:00:00.380108
16	10/23/12 13:49:41.455	PQE7:17	Temporary overvoltage	V1	241.2	6.38	46:00:24.340808
17	10/23/12 13:49:41.455	PQE7:17	Temporary overvoltage	V2	241.4	6.39	46:00:24.340808
18	10/23/12 13:49:41.455	PQE7:17	Temporary overvoltage	V3	241.6	6.39	46:00:24.340808
19	10/23/12 17:40:00.000	PQE4:18	Flicker severity	V1 Plt	20		42:10:06.000000
20	10/23/12 17:40:00.000	PQE4:18	Flicker severity	V2 Plt	20		42:10:06.000000
21	10/23/12 17:40:00.000	PQE4:18	Flicker severity	V3 Plt	20		42:10:06.000000
22	10/25/12 11:50:05.796	PQE5:19	Voltage dip	V1	0	0.00	0:00:00.290098
23	10/25/12 11:50:05.796	PQE5:19	Voltage dip	V2	0	0.00	0:00:00.290098
24	10/25/12 11:50:05.796	PQE5:19	Voltage dip	V3	1.1	0.03	0:00:00.290098
25	10/25/12 13:36:13.474	PQE7:22	Temporary overvoltage	V1	234	6.19	0:01:57.714312
26	10/25/12 13:36:13.474	PQE7:22	Temporary overvoltage	V2	234	6.19	0:01:57.714312
27	10/25/12 13:36:13.474	PQE7:22	Temporary overvoltage	V3	233.9	6.19	0:01:57.714312
28	10/25/12 13:38:11.188	PQE5:23	Voltage dip	V1	0	0.00	0:00:00.270665
29	10/25/12 13:38:11.188	PQE5:23	Voltage dip	V2	1.1	0.03	0:00:00.270665
30	10/25/12 13:38:11.188	PQE5:23	Voltage dip	V3	0	0.00	0:00:00.270665

Selecting Primary and Secondary Units

Voltages and currents can be displayed in primary or secondary units. To select units for your report, click on the report window with the right mouse button, select Options, select the desired units for voltages and currents, and then click OK.

Filtering and Sorting Events

To filter events, click on the Filter button , or click on the report window with the right mouse button and select "Filter...", check the categories of events you want to display, and then click OK.

To change the default event sorting order, click on the Sort button , or click on the report window with the right mouse button and select "Sort...", check the desired sort order, and then click OK.

The screenshot shows the 'PQ Log - PM180_USB' application window. The main window displays a table of power quality events. The table has columns for No., Date/Time, Event, Fault Category, Phase, Fault Magnitude, PU, and Duration. The events listed include various types of overvoltages, flicker severity, and voltage dips across three phases (V1, V2, V3). A 'Filter' dialog box is open over the table, allowing users to select which event types to display. The dialog has checkboxes for 'Check All', 'Clear All', and several event categories: Power frequency, Voltage variations, Rapid voltage changes, Flicker severity, Voltage dips, Voltage interruptions, Temporary overvoltages, Transient overvoltages, Voltage unbalance, Harmonic voltage, Interharmonic voltage, and Mains signaling voltage. The 'Event' column in the table contains blue-colored event IDs (e.g., PQE7:9, PQE4:10, PQE5:11) which are clickable links to related waveforms or data records.

No.	Date/Time	Event	Fault Category	Phase	Fault Magnitude	PU	Duration
1	10/14/12 10:53:39.435	PQE7:9	Temporary overvoltage	V1	244.3	6.46	218:33:35.878190
2	10/14/12 10:53:39.435	PQE7:9	Temporary overvoltage	V2	244.3	6.46	218:33:35.878190
3	10/14/12 10:53:39.435	PQE7:9	Temporary overvoltage	V3	244.3	6.46	218:33:35.878190
4	10/14/12 14:50:01.000	PQE4:10	Flicker severity	V1 PIt	20		214:37:14.000000
5	10/14/12 14:50:01.000	PQE4:10	Flicker severity	V2 PIt	20		214:37:14.000000
6	10/14/12 14:50:01.000	PQE4:10	Flicker severity	V3 PIt	20		214:37:14.000000
7	10/23/12 13:27:15.314	PQE5:11	Voltage dip	V1	0	0.00	0:00:00.040015
8	10/23/12 13:27:15.314	PQE5:11	Voltage dip	V2	0	0.00	0:00:00.040015
9	10/23/12 13:27:15.314	PQE5:11	Voltage dip	V3	0	0.03	0:00:00.040015
10	10/23/12 13:41:44.467	PQE7:14	Temporary overvoltage	V1		5.19	0:07:12.031614
11	10/23/12 13:41:44.467	PQE7:14	Temporary overvoltage	V2		5.20	0:07:12.031614
12	10/23/12 13:41:44.467	PQE7:14	Temporary overvoltage	V3		5.19	0:07:12.031614
13	10/23/12 13:48:56.499	PQE5:15	Voltage dip	V1		0.03	0:00:00.380108
14	10/23/12 13:48:56.499	PQE5:15	Voltage dip	V2		0.03	0:00:00.380108
15	10/23/12 13:48:56.499	PQE5:15	Voltage dip	V3		0.00	0:00:00.380108
16	10/23/12 13:49:41.455	PQE7:17	Temporary overvoltage	V1		5.38	46:00:24.340808
17	10/23/12 13:49:41.455	PQE7:17	Temporary overvoltage	V2		5.39	46:00:24.340808
18	10/23/12 13:49:41.455	PQE7:17	Temporary overvoltage	V3		5.39	46:00:24.340808
19	10/23/12 17:40:00.000	PQE4:18	Flicker severity	V1 PIt			42:10:06.000000
20	10/23/12 17:40:00.000	PQE4:18	Flicker severity	V2 PIt			42:10:06.000000
21	10/23/12 17:40:00.000	PQE4:18	Flicker severity	V3 PIt			42:10:06.000000
22	10/25/12 11:50:05.796	PQE5:19	Voltage dip	V1		0.00	0:00:00.290098
23	10/25/12 11:50:05.796	PQE5:19	Voltage dip	V2		0.00	0:00:00.290098
24	10/25/12 11:50:05.796	PQE5:19	Voltage dip	V3		0.03	0:00:00.290098
25	10/25/12 13:36:13.474	PQE7:22	Temporary overvoltage	V1		5.19	0:01:57.714312
26	10/25/12 13:36:13.474	PQE7:22	Temporary overvoltage	V2		5.19	0:01:57.714312
27	10/25/12 13:36:13.474	PQE7:22	Temporary overvoltage	V3		5.19	0:01:57.714312
28	10/25/12 13:38:11.188	PQE5:23	Voltage dip	V1		0.00	0:00:00.270665
29	10/25/12 13:38:11.188	PQE5:23	Voltage dip	V2		0.03	0:00:00.270665
30	10/25/12 13:38:11.188	PQE5:23	Voltage dip	V3		0.00	0:00:00.270665

Linking to Waveforms and Data Records

PQ events for which PAS finds related links are blue colored. Click on the colored event ID to check a list of the event links. Click on a list item to move to the related waveform or data log records. Data log records associated with the event are taken into a separate window for easy viewing and trending.

Retrieving Waveforms Online

If you programmed the PQ recorder to record waveforms on power quality events, you can upload the waveforms related to a specific event online if they have not yet been retrieved and stored to the database on your PC. Events for which PAS did not find a corresponding waveform in the database are still black colored. Click on the event ID, click on the "Retrieve Waveform" prompt, and then point to a database to which you want the waveform to be stored.

Viewing the ITI (CBEMA) Curve

Impulsive transients and short-duration voltage variations (sags and swells) can be viewed as magnitude/duration pairs on the ITIC (the Information Technology Industry Council, formerly CBEMA) curve chart. To view an ITI curve chart, click on the "ITI" button on the window toolbar.

To view the event details, click on the event point with the left mouse button. To directly move to the related power quality report entry or to a waveform record, click on the corresponding list item with the left mouse button.

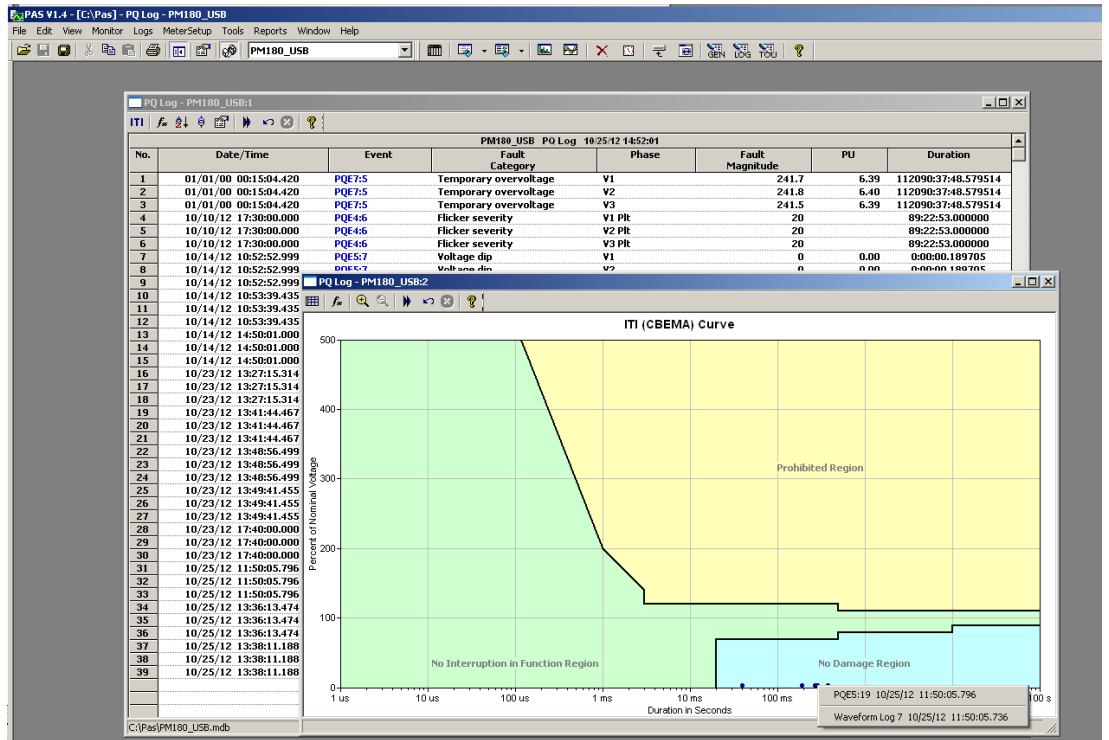

Viewing the IEEE 1159 Statistics Report

PAS can generate IEEE 1159 statistics reports on the collected power quality event data.

To get an IEEE 1159 statistics report, select "IEEE 1159 Statistics" from the Reports menu, point to the database where you stored the retrieved power quality log data, and then click Open.

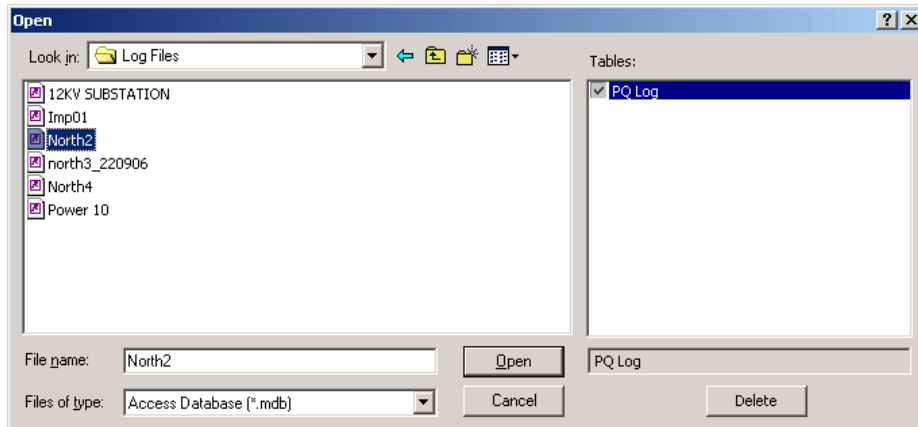

The IEEE 1159 statistics is reported within the selected time range on either a weekly, or yearly basis.

Statistics of power quality incidents for voltage imbalance, harmonics, flicker and frequency variations are given on a per week basis. The report shows the number of incidents, and a total time and a percentage of the observation time within which the characteristic exceeds the standard limit.

For voltage transients, sags, swells and interruptions, the report gives the yearly statistical data classified by voltage magnitude and duration.

An example of the IEEE 1159 statistics report is shown in the following picture.

North 2 Wed, Oct 18, 2006

IEEE 1159 Power Quality Report
21/09/06 - 25/09/06

Impulsive Transients

Overshoot Magnitude (u), %Un	Polyphase Incidents	V1 Incidents	V2 Incidents	V3 Incidents
21/09/06 - 25/09/06				
u > 20	0	0	0	0
u > 50	2	1	1	0
u > 100	2	0	0	2
u > 150	2	2	0	0
u > 200	0	0	0	0

Voltage Sags and Undervoltages

Residual Voltage (u), %Un	Instantaneous, 0.5-30 cycles	Momentary, 30 cycles - 3 s	Temporary, 3 s - 1 min	Undervoltage, > 1 min
21/09/06 - 25/09/06				
u <= 90	4	2	4	0
u <= 85	0	0	0	0
u <= 70	0	0	0	0
u <= 40	2	0	1	0

Voltage Swells and Overvoltages

Magnitude (u), %Un	Instantaneous, 0.5-30 cycles	Momentary, 30 cycles - 3 s	Temporary, 3 s - 1 min	Overvoltage, > 1 min
21/09/06 - 25/09/06				
u > 110	0	0	4	1
u > 120	0	3	2	0
u > 140	0	0	0	0
u > 160	5	2	4	0
u > 200	0	0	0	0

Flicker

From	To	Incidents	Total Duration, h:m:s:ms	Percent of Observation Time, %	Worst-case Phase	Max Pst
21/09/06	23/09/06	1	00:00:34:000	0.0	V1	25.08
24/09/06	25/09/06	3	00:25:23:000	1.3	V1	45.35

D:\Pas\Log Files\North2.mdb Ready 18/10/06 20:03:22

Changing the Report Time Range and Contents

Click on the report with the right mouse button, select "Options...", select the required time range, check the voltage characteristics to be included in the report, and then click OK.

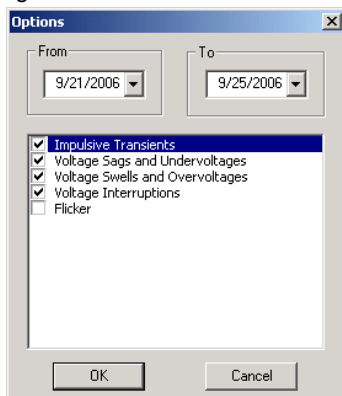

Customizing Reports

If you wish to add a logo image, header and footer to your reports:

1. Select “Report Setup...” from the Reports menu, or click on the report window with the right mouse button, and then select “Report Setup...”.

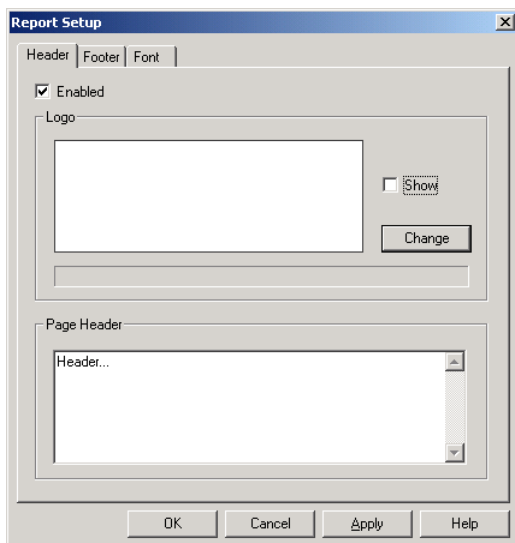

2. Click on the Change button and select a logo image file. Check the “Show” box to include your logo into a report.
3. Type the header text in the Page Header box. Check the “Enabled” box to include the header into a report.
4. Click on the Footer tab and type the footer text. Check the “Enabled” box to include the footer into a report.
5. Click OK.

Both the header and the footer may contain more than one line of the text. Use the Enter button to move to the next line as usually.

Viewing EN50160 Statistics Reports

Viewing the EN50160 Compliance Report

To get the EN50160 Compliance report, select “EN50160 Compliance Statistics” from the Reports menu, point to the database where you stored the retrieved statistics data, uncheck the voltage characteristics’ tables you do not want to be reported, and then click Open.

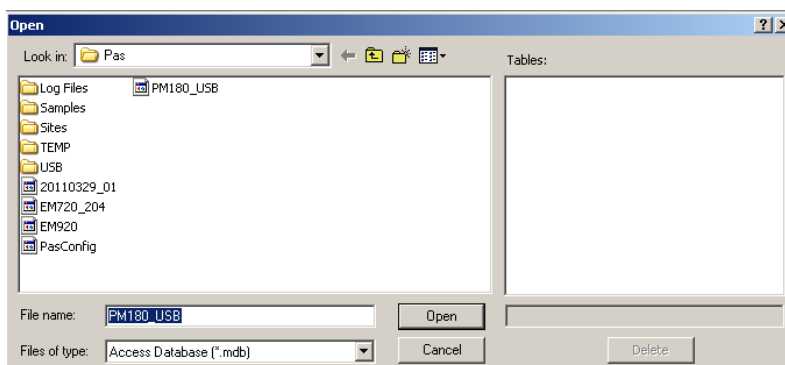

An example of the EN50160 compliance report is shown in the following picture.

EN50160 Compliance Report
 North 3
 Wed, Oct 18, 2006
 26/08/06 - 16/09/06

Power Frequency

From	To	In-service time, %	Compliance +/-1%, % of time	Compliance +/-6%, % of time	Min Frequency Hz	Max Frequency Hz	Standard Compliance
26/08/06	26/08/06	77.85	100.00	100.00	49.56	50.17	Ok
27/08/06	02/09/06	100.00	100.00	100.00	49.59	50.21	Ok
03/09/06	09/09/06	100.00	100.00	100.00	49.48	50.16	Ok
10/09/06	16/09/06	100.00	99.96	100.00	49.10	50.23	Ok
Annual report							
26/08/06	16/09/06	7.25	99.99	100.00	49.10	50.23	Ok

Voltage Variations

From	To	In-service time, %	Compliance +/-10%, % of time	Compliance +10/-15%, % of time	V1 Min	V1 Max	V2 Min	V2 Max	V3 Min	V3 Max	Standard Compliance
26/08/06	26/08/06	77.78	100.00	100.00	23060	23719	22990	23663	23057	23748	Ok
27/08/06	02/09/06	100.00	100.00	100.00	22998	23671	22929	23596	23011	23703	Ok
03/09/06	09/09/06	100.00	100.00	100.00	23021	23701	22989	23608	23050	23712	Ok
10/09/06	16/09/06	100.00	100.00	100.00	23002	23792	22949	23728	23010	23805	Ok

Voltage Dips

Residual Voltage (u), %Un	Duration (t)						
	t < 100ms	t < 500ms	t < 1s	t < 3s	t < 20s	t < 60s	t < 180s
85 < u < 90	1	0	0	0	0	0	0
70 < u <= 85	2	0	0	0	0	0	0
40 < u <= 70	0	1	0	0	0	0	0
u <= 40	1	3	0	0	0	0	0

Voltage Interruptions

Duration (t) < 1s	Duration (t) < 180s	Duration (t) > 180s
0	0	0

Temporary Overvoltages

Magnitude (u), %Un	Duration (t)		
	t < 1 s	1 s <= t < 1 min	t >= 1 min

The standard compliance statistics is reported within the selected time range on a daily, weekly or yearly basis depending on the observation periods stated in the EN50160 for voltage characteristics. If the time range includes a number of the observation intervals, each interval's statistics is given in a separate row. For power frequency, both weekly and yearly compliance statistics are provided.

For characteristics provided with definite limits, the report shows a percentage of the observation time within which the characteristic complied with the standard, e.g. 98% of the observations in a period of one week, and the total compliance indicator.

For voltage characteristics provided with indicative values, the report gives the yearly statistical data classified by voltage magnitude and duration.

Selecting the Time Range

To change the time range or contents of the report, click on the report with the right mouse button, select "Options...", select the required time range, check the voltage characteristics to be included in the report, and then click OK.

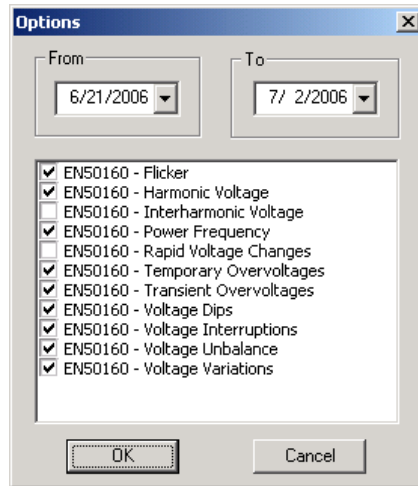

Customizing Reports

For information on how to add a logo image, the header and the footer to your reports, see [Customizing Reports](#) in the previous section.

Viewing the EN50160 Online Statistics Report

If you retrieved the EN50160 online statistics data, you can view the online report on the last retrieved statistics in the same manner as the EN50160 Compliance statistics report. Select “EN50160 Online Statistics” from the Reports menu, point to the database where you stored the retrieved online statistics, uncheck the voltage characteristics’ tables that you do not want to be reported, and then click Open.

EN 50160:2010 Online Report

PM180 Tuesday, April 16, 2019

EN 50160:2010 Online Report
16-04-19 14:42:22

Table 1 - Frequency Variation
Frequency variation, %Fn

99.5% value (low)	99.5% value (high)	Max. value (-)	Max. value (+)	99.5% Non-compliant, %	100% Non-compliant, %	99.5% limit (-)	99.5% limit (+)	100% limit (-)	100% limit (+)
0.00	0.00	0.00	0.00			-1.00	1.00	-6.00	4.00

Table 2 - Voltage Variation
Voltage variation, %Un

Voltage phase	95.0% value (low)	95.0% value (high)	Max. value (-)	Max. value (+)	95.0% Non-compliant, %	100% Non-compliant, %	95.0% limit (-)	95.0% limit (+)	100% limit (-)	100% limit (+)
Phase A	0.00	0.00	0.00	0.00						
Phase B	0.00	0.00	0.00	0.00			-10.00	10.00	-15.00	10.00
Phase C	0.00	0.00	0.00	0.00						

Table 3 - Rapid Voltage Changes
Voltage change, %Un

Phase A		Phase B		Phase C		Limit
Total changes	Max. value	Total changes	Max. value	Total changes	Max. value	
0		0		0		10.00

Table 4 - Flicker
Pit

Phase A			Phase B			Phase C			95.0% limit
95% value	Max. value	Non-compliant, %	95% value	Max. value	Non-compliant, %	95% value	Max. value	Non-compliant, %	
0.00	0.00		0.00	0.00		0.00	0.00		1.00

Table 5 - Voltage Unbalance
Vunb, %

95% value	Max. value	Non-compliant, %	95.0% limit
0.0	0.0		2.0

Table 6 - Voltage THD
THD, %u1

Phase A			Phase B			Phase C			95.0% limit
95% value	Max. value	Non-compliant, %	95% value	Max. value	Non-compliant, %	95% value	Max. value	Non-compliant, %	
0.0	0.0		0.0	0.0		0.0	0.0		8.0

Table 7 - Harmonic Voltages
Harmonics, %u1

Phase A			Phase B			Phase C		

C:\Pas\Logs\PM180.mdb

Viewing the EN50160 Harmonics Survey Report

To view the EN50160 harmonics survey report on the collected statistics data, select “EN50160 Harmonics Survey” from the Reports menu, point to the database where you stored the retrieved statistics, uncheck the voltage channels which you do not want to be reported, and then click Open.

Viewing the Fault Log

Fault log files are displayed in a tabular view. PAS loads the entire database table to a window, so that you can scroll through the entire log to view its contents.

Filtering and Sorting Events

To filter events, click on the Filter button , or click on the report window with the right mouse button and select “Filter...”, check the categories of events you want to display, and then click OK.

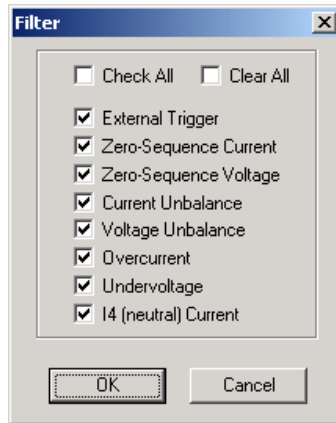

To change the sorting order, click on the Sort button , or click on the report window with the right mouse button and select "Sort...", check a desired sort order, and then click OK.

No.	Date/Time	Event	Fault Category	Phase	Amps Magnitude	PU	Volts Magnitude	PU	Duration
45	07/22/03 12:54:50.717	FE515	Overcurrent	L3	8.97	1.79	65.1	0.98	0:00:00.066
46	07/22/03 12:56:28.883	FE516	Overcurrent	L1	0.73	0.15	68.6	1.03	0:00:00.066
47	07/22/03 12:56:28.883	FE516	Overcurrent	L2	7.97	1.59	65.5	0.99	0:00:00.066
48	07/22/03 12:56:28.883	FE516	Overcurrent	L3	8.56	1.71	65.0	0.98	0:00:00.066
49	07/26/03 14:08:50.216	FE617	Undervoltage	L1	0.34	0.07	65.1	0.85	0:00:00.067
50	07/26/03 14:08:50.216	FE617	Undervoltage	L2	0.11	0.02	65.4	0.99	0:00:00.067
51	07/26/03 14:08:50.216	FE617	Undervoltage	L3	0.46	0.09	64.5	0.97	0:00:00.067
52	08/07/03 17:17:57.668	D1818	External Trigger	L1	0.62	0.12	67.9	1.02	0:00:02.638
53	08/07/03 17:17:57.668	D1818	External Trigger	L2	0.59	0.12	68.0	1.02	0:00:02.638
54	08/07/03 17:17:57.668	D1818	External Trigger	L3	0.62	0.12	67.0	1.01	0:00:02.638
55	08/07/03 19:41:40.876	FE719	14 (neutral) Current	L1	0.55	0.11	67.7	1.02	0:00:00.016
56	08/07/03 19:41:40.876	FE719	14 (neutral) Current	L2	0.52	0.10	67.8	1.02	0:00:00.016
57	08/07/03 19:41:40.876	FE719	14 (neutral) Current	L3	0.51	0.10	67.1	1.01	0:00:00.016
58	08/07/03 19:41:40.908	FE120	Zero-seq. Current	L1	0.62	0.12	67.7	1.02	0:00:00.033
59	08/07/03 19:41:40.908	FE120	Zero-seq. Current	L2	0.64	0.13	67.8	1.02	0:00:00.033
60	08/07/03 19:41:40.908	FE120	Zero-seq. Current	L3	0.55	0.11	67.1	1.01	0:00:00.033
61	08/07/03 19:41:40.943	FE721	14 (neutral) Current	L1	0.25	0.05	67.7	1.02	0:00:00.016
62	08/07/03 19:41:40.943	FE721	14 (neutral) Current	L2	0.37	0.07	67.8	1.02	0:00:00.016
63	08/07/03 19:41:40.943	FE721	14 (neutral) Current	L3	0.51	0.10	67.1	1.01	0:00:00.016
64	08/11/03 15:08:51.651	FE122	Zero-seq. Current	L1	2.05	0.41	66.7	1.00	0:00:00.099
65	08/11/03 15:08:51.651	FE122	Zero-seq. Current	L2	2.50	0.50	66.6	1.00	0:00:00.099
66	08/11/03 15:08:51.651	FE122	Zero-seq. Current	L3	4.65	0.93	60.6	0.91	0:00:00.099
67	08/11/03 15:08:51.751	FE723	14 (neutral) Current	L1	0.38	0.08	67.2	1.01	0:00:00.007
68	08/11/03 15:08:51.751	FE723	14 (neutral) Current	L2	0.42	0.08	67.0	1.01	0:00:00.007
69	08/11/03 15:08:51.751	FE723	14 (neutral) Current	L3	0.46	0.09	66.4	1.00	0:00:00.007
70	08/17/03 08:33:16.606	D1424	External Trigger	L1	0.59	0.12	67.9	1.02	4:01:30.348
71	08/17/03 08:33:16.606	D1424	External Trigger	L2	0.76	0.15	69.6	1.05	4:01:30.348
72	08/17/03 08:33:16.606	D1424	External Trigger	L3	0.71	0.14	68.7	1.03	4:01:30.348
73	08/28/03 05:03:42.162	D1425	External Trigger	L1	0.49	0.10	68.3	1.03	3:39:26.324
74	08/28/03 05:03:42.162	D1425	External Trigger	L2	0.46	0.09	68.5	1.03	3:39:26.324
75	08/28/03 05:03:42.162	D1425	External Trigger	L3	0.48	0.10	67.6	1.02	3:39:26.324
76	08/28/03 16:41:49.314	FE626	Undervoltage	L1	0.83	0.17	67.4	1.02	0:00:00.050
77	08/28/03 16:41:49.314	FE626	Undervoltage	L2	0.95	0.19	67.5	1.02	0:00:00.050
78	08/28/03 16:41:49.314	FE626	Undervoltage	L3	1.60	0.32	52.5	0.79	0:00:00.050
79	08/28/03 16:41:49.365	FE727	14 (neutral) Current	L1	0.36	0.07	67.5	1.02	0:00:00.016
80	08/28/03 16:41:49.365	FE727	14 (neutral) Current	L2	0.41	0.08	67.3	1.01	0:00:00.016
81	08/28/03 16:41:49.365	FE727	14 (neutral) Current	L3	0.34	0.07	66.5	1.00	0:00:00.016
82	08/28/03 16:43:51.434	FE128	Zero-seq. Current	L1	2.08	0.42	67.8	1.02	0:00:00.074
83	08/28/03 16:43:51.434	FE128	Zero-seq. Current	L2	3.46	0.69	61.2	0.92	0:00:00.074
84	08/28/03 16:43:51.434	FE128	Zero-seq. Current	L3	2.38	0.48	66.2	1.00	0:00:00.074

Selecting Primary and Secondary Units

Voltages and currents can be displayed in primary or secondary units. To select units for your data views, click on the report window with the right mouse button, select Options, select the desired units for voltages and currents, and then click OK.

Linking to Waveforms and Data Records

When displaying the fault report, PAS establishes links between the event and related waveforms and data log records. Fault events for which PAS finds related links are blue colored.

Click on the colored event ID with the left mouse button to check a list of the event links. Click on a list item to move to the related waveform or data log records. Data log records associated with the fault event are taken into a separate window for easy viewing and trending.

Viewing the Data Log

Data log files can be displayed in a tabular view, one data record per row, or in a graphical view as a data trend graph.

No.	Date/Time	Event	V1	V2	V3	I1	I2	I3	kW	kvar	kVA	PF	V1 THD	V2 THD	V3 THD	I1 THD	I2 THD	I3 THD
26	10/16/12 21:30:00.000	SP1	234.8	235.9	236.1	0.01	0.01	0.01	0.001	0	0.001	-0.924	2.3	2.3	2.3	0	0	0
27	10/16/12 21:45:00.003	SP1	235.5	236.1	236	0.01	0.01	0.01	0	0	0	-0.251	2.3	2.3	2.3	0	0	0
28	10/16/12 22:00:00.006	SP1	234.4	234.5	234.5	0.01	0.01	0.01	0	0	0	0.628	2.4	2.3	2.3	0	0	0
29	10/16/12 22:15:00.008	SP1	234.2	235	235.1	0.01	0.01	0.01	0	-0.001	0.001	-0.418	2.4	2.3	2.3	0	0	0
30	10/16/12 22:30:00.010	SP1	234.8	235.4	235	0.01	0.01	0.01	0	0	0	-0.547	2.3	2.2	2.2	0	0	0
31	10/16/12 22:45:00.003	SP1	234.4	235.5	235.1	0.01	0	0.01	0	0	0	0.739	2.5	2.3	2.3	0	0	0
32	10/16/12 23:00:00.009	SP1	234.5	235.3	234.5	0.01	0	0	0	0	0	1	2.4	2.3	2.3	0	0	0
33	10/16/12 23:15:00.000	SP1	235.4	236	236	0.01	0.01	0	0	0	0	0.999	2.3	2.4	2.3	0	0	0
34	10/16/12 23:30:00.003	SP1	235.3	234.9	234.3	0.01	0	0.01	0	0	0	1	2.3	2.4	2.4	0	0	0
35	10/16/12 23:45:00.008	SP1	235.6	235.7	236.4	0.01	0.01	0.01	-0.001	-0.001	0.001	0.787	2.3	2.3	2.4	0	0	0
36	10/17/12 00:00:00.006	SP1	235.1	235.5	235.4	0.01	0.01	0.01	0	0	0	-0.961	2.7	2.7	2.7	0	0	0
37	10/17/12 00:15:00.009	SP1	233.9	233.9	234.1	0.01	0.01	0.01	0	0	0	-0.952	2.7	2.6	2.6	0	0	0
38	10/17/12 00:30:00.003	SP1	234.7	235.9	234.5	0.01	0.01	0.01	0	0	0.001	0.465	2.7	2.6	2.6	0	0	0
39	10/17/12 00:45:00.006	SP1	236.5	236	235.3	0.01	0.01	0.01	0	0	0	0.639	2.9	2.8	2.8	0	0	0
40	10/17/12 01:00:00.010	SP1	236.2	237	236.7	0.01	0.01	0.01	0	0	0	-0.447	2.9	2.8	2.9	0	0	0
41	10/17/12 01:15:00.002	SP1	234.7	235.2	234.9	0.01	0.01	0.01	0.001	0	0.001	0.876	2.8	2.8	2.8	0	0	0
42	10/17/12 01:30:00.004	SP1	234.6	233.8	234.7	0.01	0.01	0.01	-0.001	0	0.001	0.987	2.9	2.8	2.9	0	0	0
43	10/17/12 01:45:00.010	SP1	234.1	234	233.9	0.01	0.01	0.01	0	0	0	-0.884	3	3	3	0	0	0
44	10/17/12 02:00:00.005	SP1	235.7	235.4	236	0.01	0.01	0.01	0	-0.001	0.001	0.387	3	2.9	2.9	0	0	0
45	10/17/12 02:15:00.002	SP1	235.2	235.6	235.3	0.01	0.01	0.01	0	0.001	0.001	-0.445	2.9	2.9	2.8	0	0	0
46	10/17/12 02:30:00.009	SP1	235.8	236	235.7	0.01	0.01	0.01	0	0	0	0.999	2.9	2.9	3	0	0	0
47	10/17/12 02:45:00.009	SP1	236.4	236.3	235.9	0.01	0.01	0.01	0	0	0	0.461	2.9	2.9	3	0	0	0
48	10/17/12 03:00:00.003	SP1	235.8	237.5	236.5	0.01	0.01	0	0	0	0	0.739	3	2.9	2.9	0	0	0
49	10/17/12 03:15:00.003	SP1	235.8	236	235.3	0.01	0.01	0	0	0	0	-0.957	3	3	3	0	0	0
50	10/17/12 03:30:00.006	SP1	235.1	234.5	234.2	0.01	0.01	0.01	0	0	0	-0.880	3	2.9	2.9	0	0	0
51	10/17/12 03:45:00.009	SP1	234.7	235.2	235.3	0.01	0.01	0.01	0	0	0	0.934	2.9	2.9	2.9	0	0	0
52	10/17/12 04:00:00.007	SP1	235.7	234.6	234.5	0.01	0.01	0.01	0	0	0	-0.396	3	3	3	0	0	0
53	10/17/12 04:15:00.000	SP1	235.1	234.8	234.5	0.01	0.01	0.01	0	0	0	0.566	3	2.9	2.9	0	0	0
54	10/17/12 04:30:00.002	SP1	234.1	234.1	234	0.01	0	0	0	0	0	-0.481	3	2.9	2.9	0	0	0
55	10/17/12 04:45:00.005	SP1	235.5	236.1	235.3	0.01	0.01	0.01	0	0	0	-0.031	2.9	2.9	2.9	0	0	0
56	10/17/12 05:00:00.002	SP1	234	233.6	234	0.01	0	0	0	0	0	-0.556	2.9	2.9	2.9	0	0	0
57	10/17/12 05:15:00.008	SP1	236.7	236.1	236	0.01	0.01	0.01	0.001	0	0.001	-0.853	2.9	2.9	2.9	0	0	0
58	10/17/12 05:30:00.001	SP1	235.2	234.7	234.4	0.01	0.01	0.01	0	0	0	0.796	2.9	3	2.9	0	0	0
59	10/17/12 05:45:00.008	SP1	235.1	235.4	234.7	0.01	0.01	0.01	0	0	0	-0.873	2.8	2.8	2.8	0	0	0
60	10/17/12 06:00:00.005	SP1	234.2	234.3	233.6	0.01	0.01	-0.001	-0.001	-0.001	0.001	0.644	2.9	2.8	2.8	0	0	0
61	10/17/12 06:15:00.008	SP1	233.6	233.2	233.9	0.01	0.01	0	0	0	0	-0.981	2.7	2.6	2.7	0	0	0
62	10/17/12 06:30:00.002	SP1	236.1	235	235.4	0.01	0	0	0	0	0	-0.149	2.7	2.7	2.8	0	0	0
63	10/17/12 06:45:00.001	SP1	234.4	233.9	234	0.01	0.01	0.01	0	0	0	1	2.9	2.8	2.8	0	0	0
64	10/17/12 07:00:00.007	SP1	233.3	233.4	234.3	0.01	0	0	0	0	0	1	2.7	2.7	2.7	0	0	0
65	10/17/12 07:15:00.005	SP1	236	235.2	234.9	0.01	0.01	0.01	0	-0.001	0.001	0.505	2.2	2.3	2.3	0	0	0

Viewing Data Trend

To view data in a graphical form, click on the Data Trend  button on the local toolbar.

To change the time range for your graph, click on the Time Range button  on the local toolbar, and then select the desired date and time range.

Selecting Channels

To select desired data channels for your trend, click on the trend window with the right mouse button, select “Channels”, check the channels you want displayed, and then click OK.

Customizing Line Colors and Styles

Trend lines for different channels can be shown in different colors using different line styles. To change the colors or line styles, click on the trend window with the right mouse button, select “Options...”, click on the “Display” tab, adjust colors and styles for channels, and then click OK. You can also change the colors for the background and gridlines.

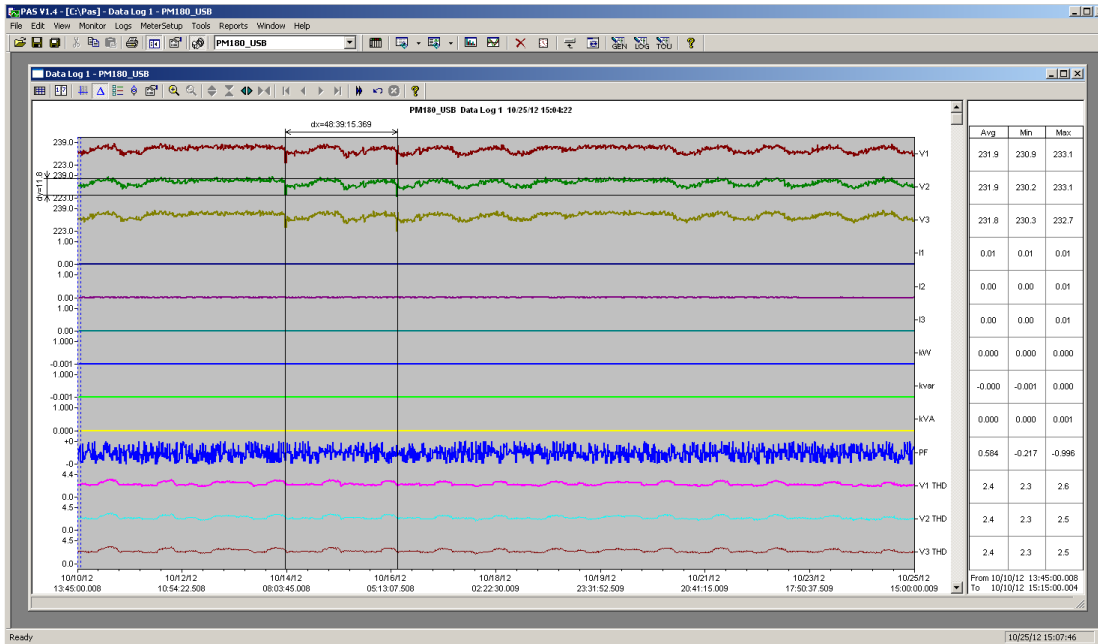



Using the Marker Lines

The trend window has two blue dashed marker lines. The left marker indicates the starting position and the right marker indicates the end position for calculating the average and peak values.

To change the marker position, click on the trend window with the right mouse button, select Set Marker, or click on the  button on the window toolbar, and then click with left mouse button on the point where you want to put the marker. You can also drag both markers with the mouse, or use the right and left arrow keys on your keyboard to change the marker position (click on the trend pane with the mouse before using the keyboard, to allow the keyboard to receive your input).

Using a Zoom

You can use a horizontal and a vertical zoom to change size of your graph. Use the  buttons on your local toolbar representing green arrowheads to zoom in and zoom out. One click gives you a 100-percent horizontal zoom. Two buttons  representing magnifying glasses give you a proportional zoom in both directions.

Delta Measurements



To measure the distance between two trend points, click on the Delta button , then click on the first point, and then click on the second point. The first reference point is still frozen until you close and reopen Delta, while the second point can be placed anywhere within the trend line. You can measure a delta in both directions. To disable delta measurements, click on the Delta button once again.

Viewing Waveforms

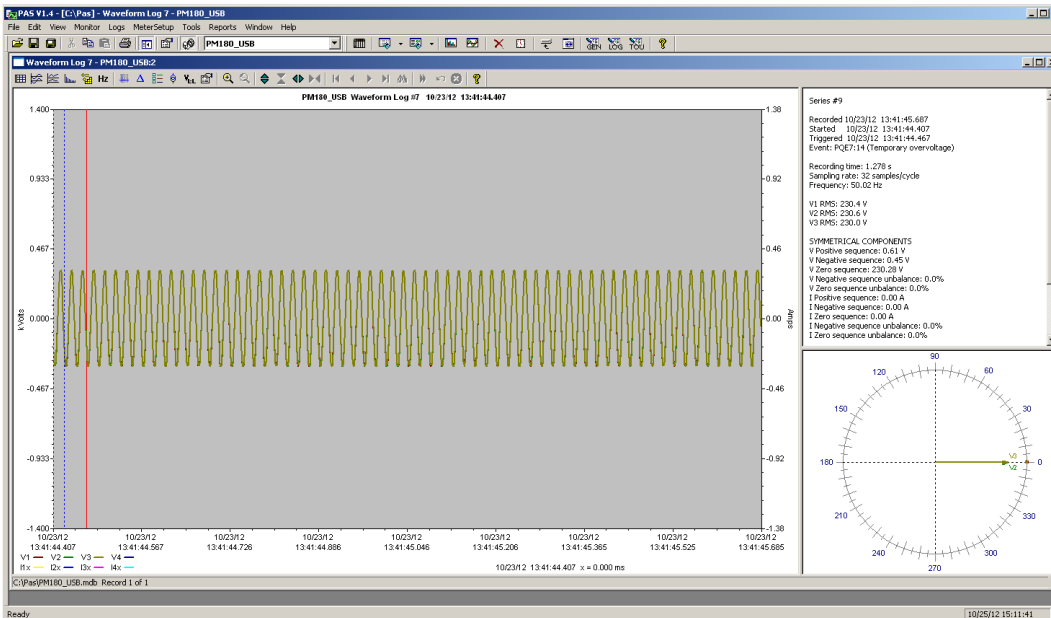
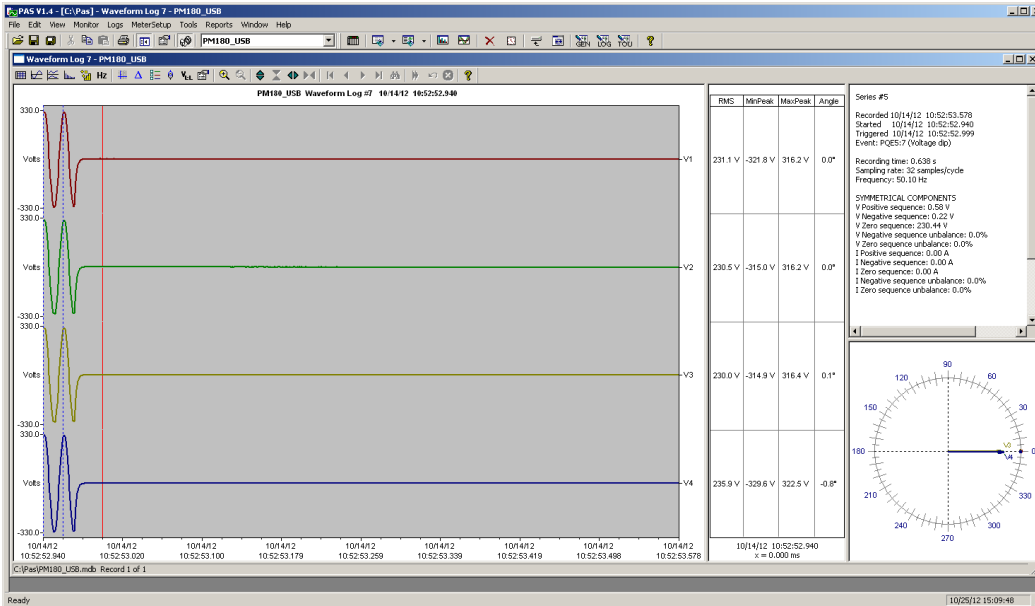
Waveform data can be displayed in five different views. When you open a new file, PAS shows you a waveform graph showing non-overlapped waveforms. Each waveform window has a local toolbar from where you can open another window to examine the waveform in a different view.



You can open all five views together to analyze different properties of the waveform like a wave shape, waveform disturbance, unbalance, or spectrum. When you move to another waveform record, all views are updated simultaneously to reflect the changes.

To view overlapped waveforms, click on the  button on the local toolbar; to view non-overlapped waveforms, click on the  button.

Waveform data is recorded in series that may contain many cycles of the sampled waveform. A waveform window displays up to 128 waveform cycles. If the waveform contains more cycles, the scroll bar appears under the waveform pane allowing you to scroll through the entire waveform.

Viewing an RMS Plot

PAS can show you a cycle-by-cycle RMS plot of the sampled AC waveforms. To open the RMS view, click on the  button. The graph shows the RMS points updated each half cycle.

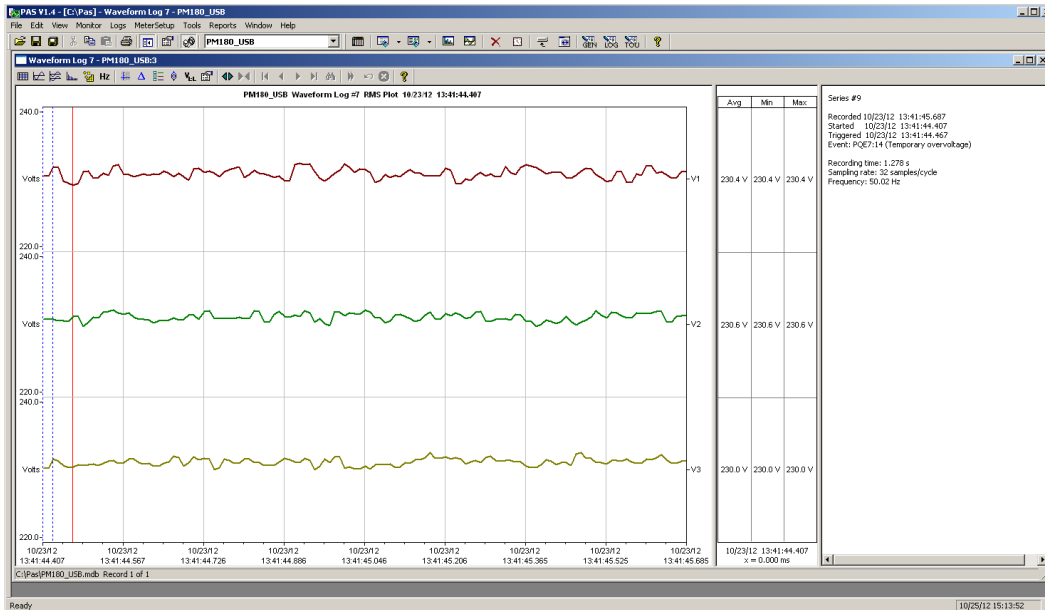

Viewing a Frequency Plot

To view a cycle-by-cycle frequency plot of the sampled voltage waveforms, click on the **Hz** button.

Viewing a Spectrum Chart

Click on the  button to view a spectrum chart for the selected waveform channel. To change a channel, click on the window with the right mouse button, select "Channels...", check the channel you want displayed, and then click OK. PAS provides voltage, current, active power and reactive power spectrum charts.

A spectrum is calculated over four cycles of the waveform beginning from the point where the left marker line is located in the open waveform view. If both waveform views are open, PAS gives the priority to the overlapped waveform view.

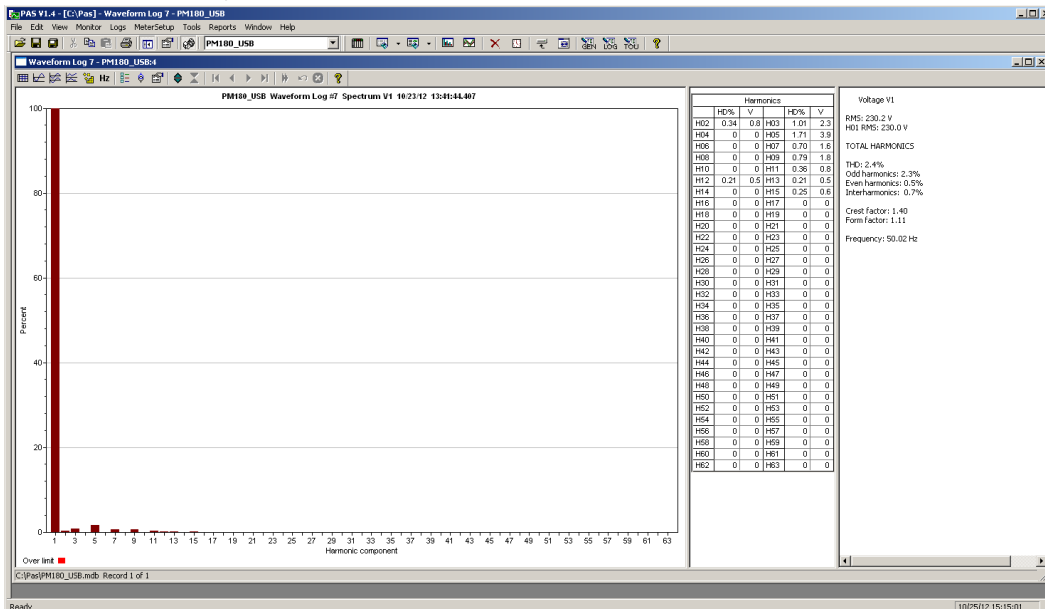

The order of the highest displayed harmonic component is equal to the half sampling rate at which the waveforms are sampled minus one. If the waveform was sampled at a rate of 256 samples per cycle, 63 harmonics are available. With 32 samples per cycle, only 15 harmonics are calculated, while others will be zeros.

PAS can give you indication on whether harmonic levels in the sampled waveforms exceed compliance limits defined by the power quality standards or local regulations.

To review or change harmonic limits:

1. Click on the spectrum window with the right mouse button and select “Limits...”.
2. Select a harmonics standard, or select “Custom” and specify your own harmonic limits.
3. Check the Enabled box to visualize harmonic faults on the spectrum graph and in harmonic tables.

Harmonics that exceed selected compliance levels are colored in red on the graph and in the tables.

Voltage		Current	
Harm. Distortion, %		Harm. Emission, Amp	
H02	2.0	H02	28.9
H03	5.0	H03	48.1
H04	0.1	H04	9.0
H05	6.0	H05	28.9
H06	0.5	H06	3.0
H07	5.0	H07	41.2
H08	0.5	H08	7.2
H09	1.5	H09	9.6
H10	0.5	H10	5.8
H11	3.5	H11	39.4
H12	0.5	H12	1.2
H13	3.0	H13	27.8
H14	0.5	H14	2.1
H15	0.5	H15	1.4
H16	0.5	H16	1.8
H17	2.0	H17	13.6
H18	0.5	H18	0.8
H19	1.5	H19	9.1
H20	0.5	H20	1.4
H21	0.5	H21	0.7
H22	0.5	H22	1.3
H23	1.5	H23	7.5
H24	0.5	H24	0.6
H25	1.5	H25	4.0
H26	0.5	H26	1.1
H27	1.5	H27	0.5

Viewing a Spectrum Table

Click on the  button on the local toolbar to display the harmonics spectrum in a tabular view for a selected phase or for all phases together.

The spectrum table shows voltage, current, active power and reactive power harmonic components both in percent of the fundamental and in natural units, and harmonic phase angles.

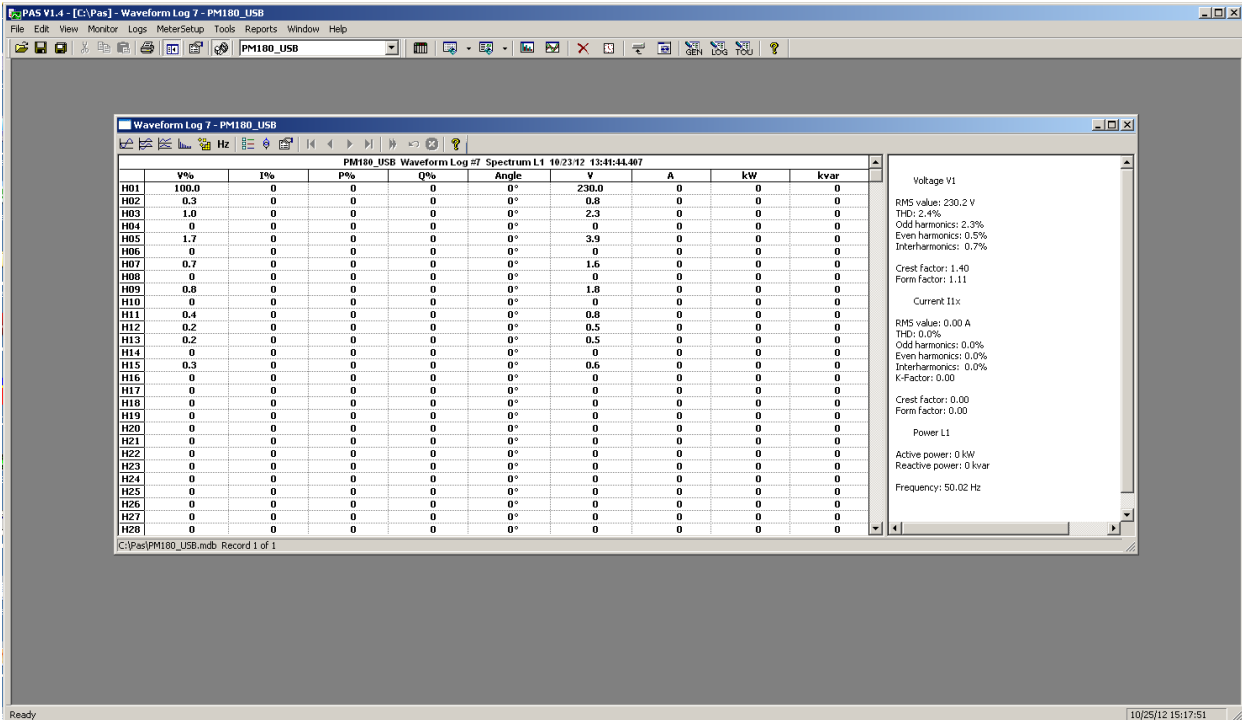

To change a phase, click on the window with the right mouse button, select “Options...”, check the phase you want displayed, and then click OK.

Waveform Options

Scrolling through Waveforms

The status bar at the bottom of the window shows you how many records the log file contains. Use green arrowheads on the window toolbar to scroll through records.

Selecting Waveform Channels

A single waveform record may contain up to 56 waveforms including AC, VDC, digital and analog input channels, which can be displayed all together in a non-overlapped waveform view.

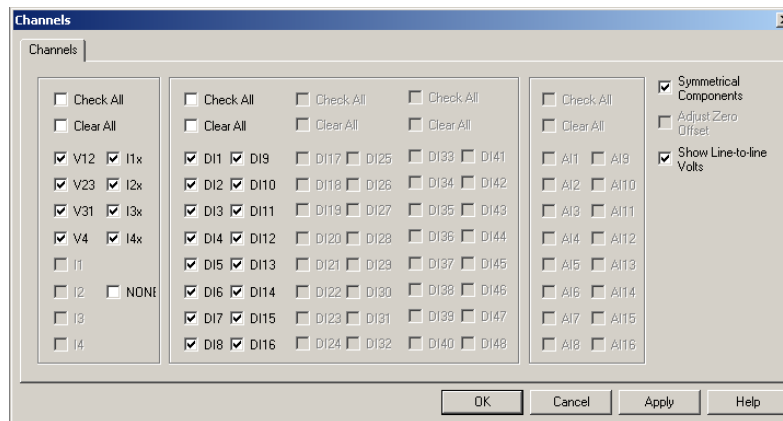

To select the channels you want to view on the screen, click on the waveform window with the right mouse button, select “Channels...”, check the channels you want displayed, and then click OK. Checkboxes for channels that are not present in the waveform are dimmed.

Selecting the Time Axis

The horizontal axis can be displayed either in absolute time with date and time stamps, or in milliseconds relatively to the beginning of a waveform. To change the time units, click on the

waveform window with the right mouse button, select “Options...”, click on the “Axes” tab, select the desired units, and then click OK.

Customizing Line Colors and Styles

Channel waveforms are displayed using different colors and line styles. To change the colors or line styles, click on the waveform window with the right mouse button, select “Options...”, click on the Display tab, adjust colors and styles, and then click OK. You can also change the waveform background and gridlines color.

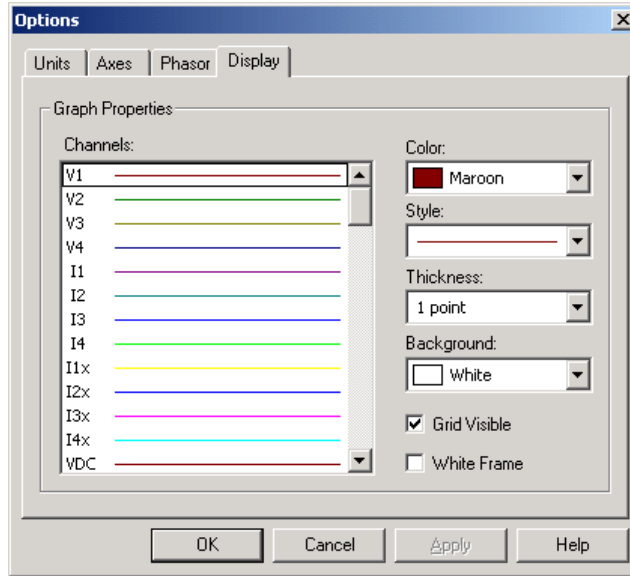

Viewing Phasor Diagrams

The phasor diagrams show you the relative magnitudes and angles of the three-phase voltage and current fundamental component. All angles are shown relative to the reference voltage channel.

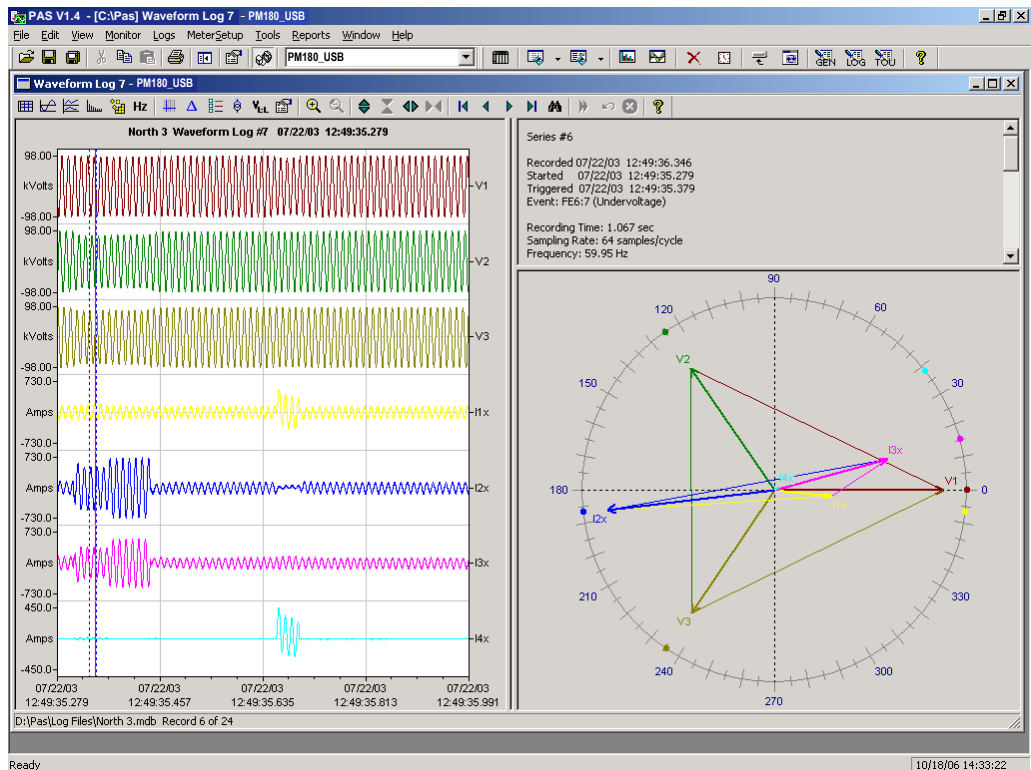

To change the reference channel, click on the waveform window with the right mouse button, select “Options...”, click on the “Phasor” tab, check the channel you want to make a reference channel, and then click “OK”.

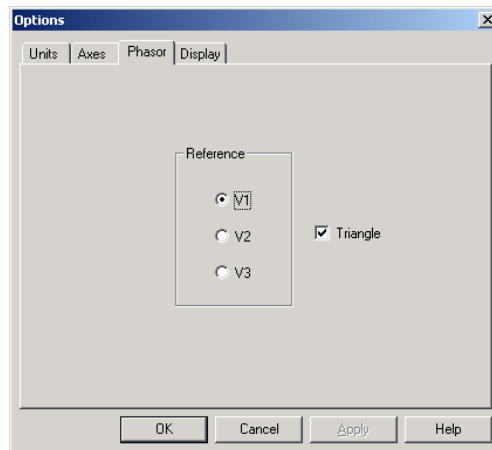

If you leave the Triangle box checked, PAS connects the ends of the voltage and current vectors showing you three-phase voltage and current triangles. This is useful when analyzing voltage and current unbalances.

Phasor diagrams are calculated over one waveform cycle pointed to by the left marker line. As you move the marker, the phasor diagrams are updated reflecting the new marker position.

Viewing Symmetrical Components

Waveform views have an additional pane at the right where PAS displays the symmetrical components for voltages and currents, calculated for the point indicated by the left marker line. To enable or disable the symmetrical components, click on the waveform window with the right mouse button, select "Options...", check or uncheck the "Symmetrical components" box on the "Channels" tab, and then click OK.

Selecting Primary and Secondary Units



Voltages and currents can be displayed in primary or secondary units. To select units for your waveforms, click on the waveform window with the right mouse button, select "Options...", select the desired units for voltages and currents on the Channels tab, and then click OK.

Using the Marker Lines

Waveform and RMS panes have two blue dashed marker lines. The left marker indicates the position from where data is taken to calculate the harmonics spectrum and phasor diagrams, and also as the starting position for calculating the RMS, average and peak values. The right marker indicates the end position for calculating the RMS, average and peak values. The minimum distance between the two markers is exactly one cycle.

To change the marker position, click on the  button, or click on the waveform window with the right mouse button and select Set Marker, and then click on the point where you want to put the marker. You can drag both markers with the mouse, or use the right and left arrow keys on your keyboard to change the marker position. Click on the waveform pane to allow the keyboard to get your input before using the keyboard.

Using a Zoom

You can use a horizontal and a vertical zoom to change size of your waveforms. Use the buttons  on your local toolbar representing green arrowheads to zoom in or out of the waveform graph. Every click on these buttons gives you a 100-percent horizontal or 50-percent vertical zoom. Two buttons  give you a proportional zoom in both directions.

When in the overlapped waveform view, you can zoom in on a selected waveform region. Click on the waveform window with the right mouse button, click 'Zoom', point onto one of the corners of the region you want to zoom in, press and hold the left mouse button, then point to another corner of the selected region and release the mouse button.

Delta Measurements

To measure the distance between two waveform points, click on the Delta button , then click on one point, and then click on the second point. The first reference point is still frozen until you close and reopen Delta, while the second point can be placed anywhere within the waveform line. You can measure a delta in both directions. To disable the Delta, click on the Delta button once again.

Viewing Synchronized Waveforms

If you have a number of devices with synchronized clocks, you can view waveforms recorded at different locations in one window. PAS can synchronize the time axes for different waveforms so they could be displayed in a single plot.

To get synchronized waveforms:

1. Put the databases with waveforms into the same folder, or put the sites from which you uploaded data to the same group in the sites tree.
2. Open a waveform you want to synchronize with other waveforms, and then click on the Multi-site View button . PAS searches for time-coordinated waveforms that have the same time span as your selected waveform.

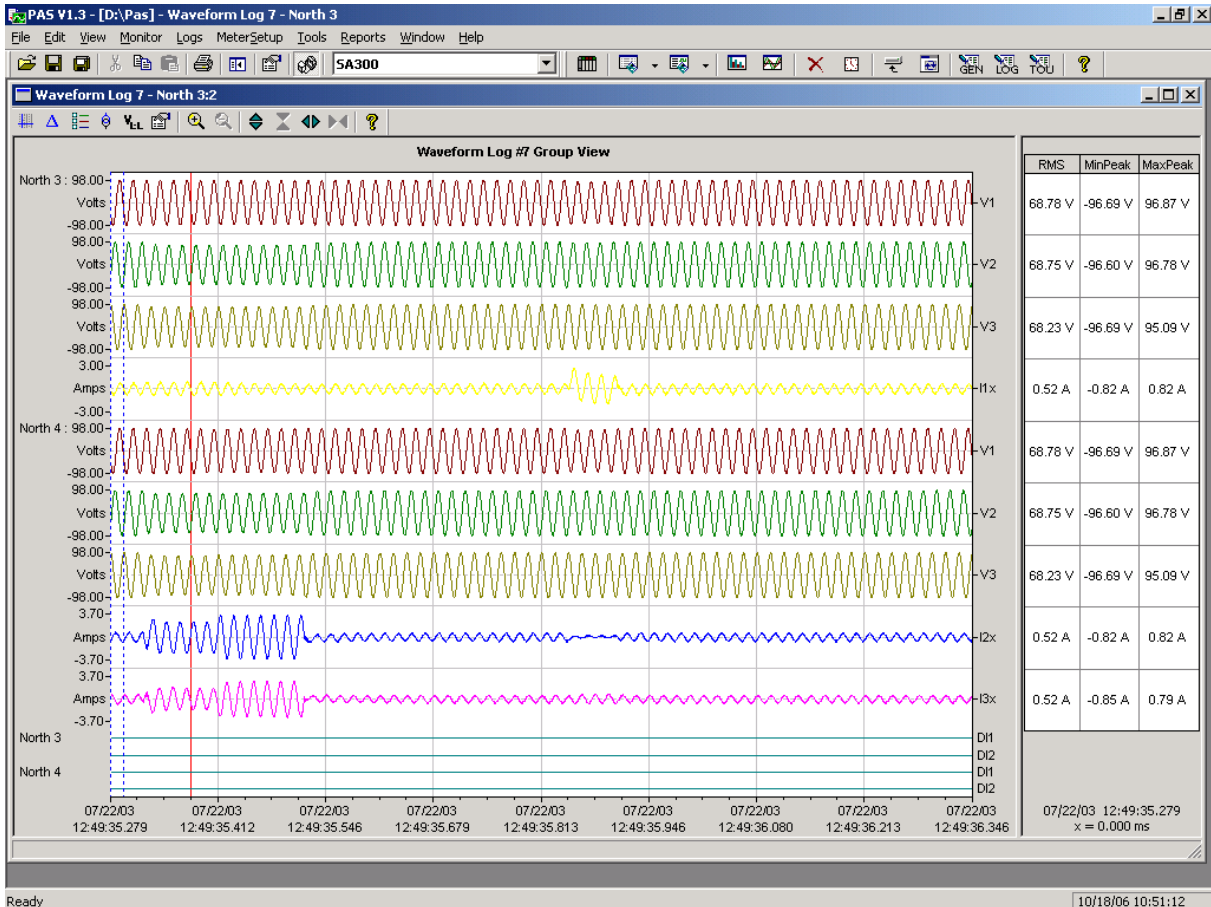

3. Check the sites you want to see displayed.

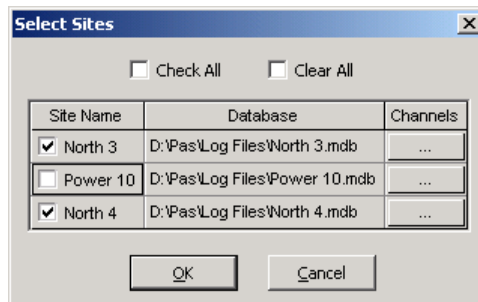

4. Click on the “Channels” button and select channels for each site.
5. Click OK.

To change the channels, click on the waveform window with the right mouse button and select “Channels...”.

Chapter 14 COMTRADE and PQDIF Converters

The COMTRADE and PQDIF file converters allow you to convert waveforms into COMTRADE or PQDIF file format, and data log tables – into PQDIF format.

Manual Converting

To manually convert your waveforms or a data log into COMTRADE or PQDIF format:

1. Click on the Export  button on the PAS toolbar.

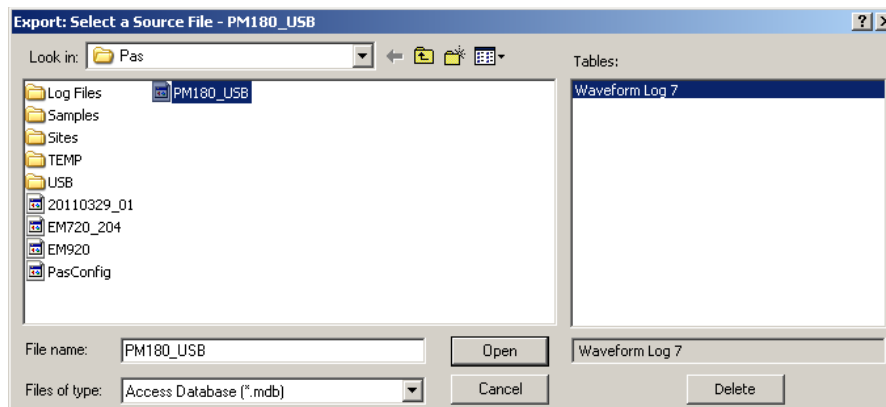

2. Select the database and a waveform or data log table you want to export, and then click Open.

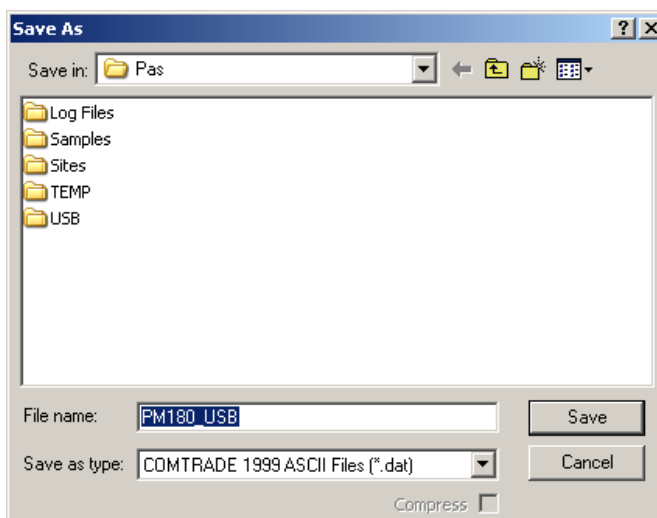

3. Select a directory where you want to store your exported files, type a file name that identifies your files, select a desired file output format, and then click on the Save button. The PQDIF files are commonly recorded in compressed format. If you do not want your files to be compressed, uncheck the Compress box before saving the file.

In COMTRADE format, each waveform event is recorded into a separate file. A COMTRADE waveform file name contains a site name followed by an ID of the fault or power quality event, which triggered the waveform record.

PQDIF file names contain a site name followed by a timestamp of the first event recorded to the file, and may look like 12KVSUB_20040928T133038.pqd.

Automatic Converting

PAS allows you to automatically convert waveform and data logs into COMTRADE or PQDIF format at the time you upload data from your devices via the Upload Scheduler.

To automatically convert your waveform or data log tables into COMTRADE or PQDIF format:
 1. Open the Upload Scheduler.

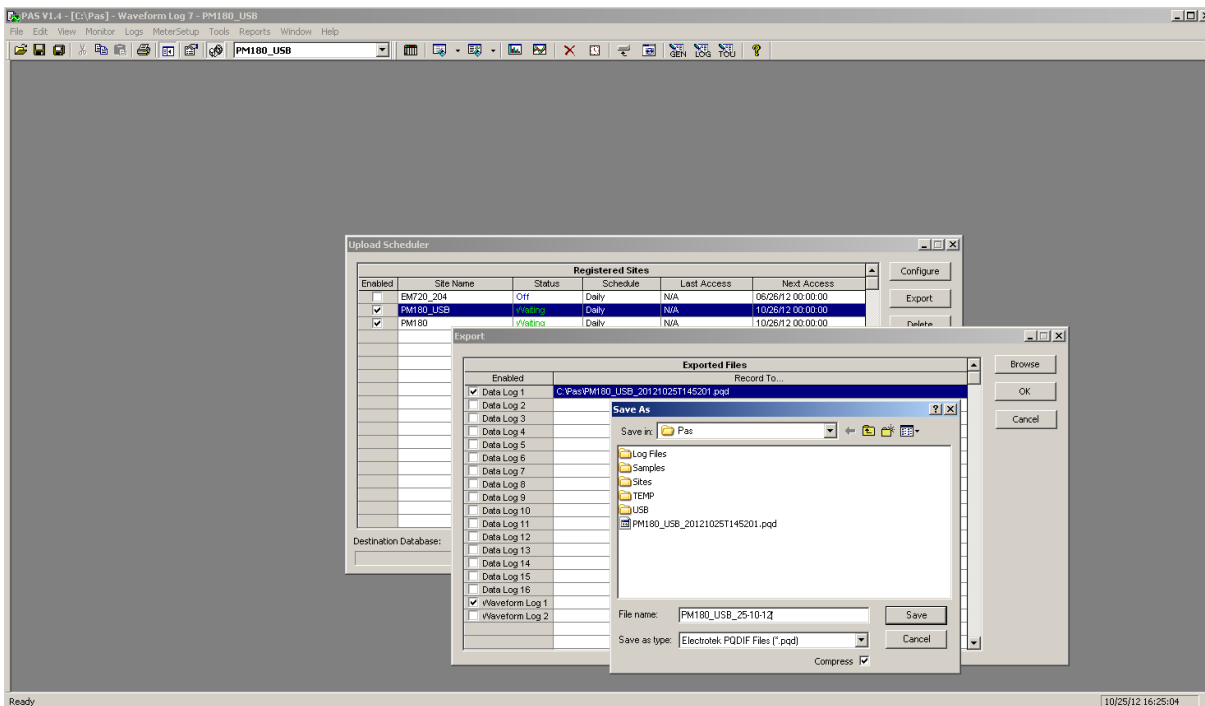

2. Highlight a desired device site with the left mouse button, and then click on the Export button.
3. Check the Enabled box for a data log or a waveform log table you want to automatically convert at the upload time.
4. Highlight the Record to... row for the selected table and click on the Browse button.
5. Select a folder where you want to store converted files, type in the converted file's name, select a desired output file format, and then click on Save.
6. Repeat the same for all tables you wish to be converted.
7. Click OK.

Appendix A Parameters for Analog Output

The following table lists parameters that can be provided on the device's analog outputs.

Designation	Description
NONE	None (output disabled)
	1-Cycle Phase Values
V1 RT	V1 Voltage
V2 RT	V2 Voltage
V3 RT	V3 Voltage
V12 RT	V12 Voltage
V23 RT	V23 Voltage
V31 RT	V31 Voltage
I1 RT	I1 Current
I2 RT	I2 Current
I3 RT	I3 Current
V1 THD RT	V1 Voltage THD
V2 THD RT	V2 Voltage THD
V3 THD RT	V3 Voltage THD
I1 THD RT	I1 Current THD
I2 THD RT	I2 Current THD
I3 THD RT	I3 Current THD
I1 TDD RT	I1 Current TDD
I2 TDD RT	I2 Current TDD
I3 TDD RT	I3 Current TDD
I1 KF RT	I1 K-Factor
I2 KF RT	I2 K-Factor
I3 KF RT	I3 K-Factor
	1-Cycle Total Values
kW RT	Total kW
kvar RT	Total kvar
kVA RT	Total kVA
PF RT	Total PF
PF LAG RT	Total PF Lag
PF LEAD RT	Total PF Lead
VOLT AVG RT	3-phase average L-N/L-L voltage
VOLT AVG LL RT	3-phase average L-L voltage
AMPS AVG RT	3-phase average current
	1-Cycle Auxiliary Values
I4 RT	I4 Current
In RT	In Current
FREQ RT	Frequency
FREQ3 RT	Frequency with 3 decimal points
VOLT DC RT	DC voltage
	Average Phase
	1-Sec Phase Values
V1 AVR	V1 Voltage
V2 AVR	V2 Voltage
V3 AVR	V3 Voltage
V12 AVR	V12 Voltage
V23 AVR	V23 Voltage
V31 AVR	V31 Voltage
I1 AVR	I1 Current
I2 AVR	I2 Current
I3 AVR	I3 Current
	1-Sec Total Values
kW AVR	Total kW
kvar AVR	Total kvar
kVA AVR	Total kVA
PF AVR	Total PF
PF LAG AVR	Total PF Lag
PF LEAD AVR	Total PF Lead
VOLT AVG AVR	3-phase average L-N voltage
VOLT AVG LL AVR	3-phase average L-L voltage
AMPS AVG AVR	3-phase average current

Designation	Description
	1-Sec Auxiliary Values
In AVR	In Current
FREQ AVR	Frequency
FREQ3 AVR	Frequency with 3 decimal points
	Present Demands
kW IMP ACC DMD	Accumulated kW import demand
kW EXP ACC DMD	Accumulated kW export demand
kvar IMP ACC DMD	Accumulated kvar import demand
kvar EXP ACC DMD	Accumulated kvar export demand
kVA ACC DMD	Accumulated kVA demand

Appendix B Setpoint Actions

Action	Target	Description
NONE		None (no action)
SET EVENT FLAG	1-16	Set user event flag 1-16
CLEAR EVENT FLAG	1-16	Clear user event flag 1-16
OPERATE RELAY	1-32	Operate relay RO1-RO32
RELEASE RELAY	1-32	Release latched relay RO1-RO32
INCREMENT COUNTER	1-32	Increment counter 1-32
DECREMENT COUNTER	1-32	Decrement counter 1-32
CLEAR COUNTER	1-32	Clear counter 1-32
RESET ENERGY		Reset total energy registers
RESET DEMANDS	ALL	Reset all maximum demand registers
RESET DEMANDS	POWER	Reset maximum power demand registers
RESET DEMANDS	VOLT/AMP	Reset maximum volts and ampere demand registers
RESET DEMANDS	VOLT	Reset maximum volt demand registers
RESET DEMANDS	AMP	Reset maximum ampere demand registers
RESET DEMANDS	HRM	Reset maximum harmonic demand registers
RESET TOU ENERGY		Reset summary and TOU energy
RESET TOU DEMANDS		Reset summary and TOU maximum demands
RESET ALL COUNTERS		Clear all counters
CLEAR MIN/MAX LOG		Clear Min/Max log registers
EVENT LOG	OPER	Event log on setpoints operated
EVENT LOG	RELS	Event log on setpoints released
EVENT LOG	ANY	Event log on any setpoints transition
DATA LOG	1-16	Data log 1-16
WAVEFORM LOG	1-8	Waveform Log 1-8
SOE LOG		SOE (Sequence of Events) Log
EXT TRIGGER	1-16	External trigger 1-16 (UDP broadcast trigger message). See Cross Triggering Setpoints .

Appendix C Parameters for Monitoring and Data Logging

The following table lists parameters measured by the PM180 that are available for monitoring via communication ports, for data logging, and for triggering setpoints.

Designation	Description
NONE	None (stub, read as zero)
SETPOINTS	Setpoints Status
SP1:32	Setpoints 1-32
SPECIAL INPUTS	Special Inputs (setpoints triggers only)
VOLT DISTURB	Voltage disturbance – waveshape fault. See Using the Voltage Disturbance Trigger .
PHASE ROTATION	Phase rotation order
EVENT FLAGS	User Event Flags
EVENT FLAG 1:16	Event Flags 1-16
STATIC EVENTS	Internal Static Events (setpoints triggers only)
PHASE ORDER ERR	Phase order error
POS PHASE ORDER	Positive (ABC) phase order
NEG PHASE ORDER	Negative (ACB) phase order
PQ EVENT	PQ event. See Power Quality Event Indication and Cross Triggering .
FAULT EVENT	General fault event: fault recorder has been triggered. See Fault Indication and Cross Triggering .
FAULT DETECTED	The embedded fault detector has detected a fault. See Fault Indication and Cross Triggering .
EXTERNAL TRIGGER	Fault recorder has been triggered via a digital input. See Fault Indication and Cross Triggering .
DEVICE FAULT	Device fault (non-critical error). See Device Fault Alarm .
NO VOLTAGE	No measured voltage
PULSED EVENTS	Internal Pulsed Events (setpoints triggers only)
kWh IMP PULSE	kWh Import pulse
kWh EXP PULSE	kWh Export pulse
kWh TOT PULSE	kWh Total pulse
kvarh IMP PULSE	kvarh Import pulse
kvarh EXP PULSE	kvarh Export pulse
kvarh TOT PULSE	kvarh Total pulse
kVAh PULSE	kVAh pulse
START DMD INT	Start of power demand interval pulse
START TRF INT	Start of tariff interval pulse
EXT TRIGGERS	External Trigger Events (setpoints triggers only)
EXT TRIGGER 1:16	External cross triggering channel 1-16 (UDP broadcast trigger message). See Cross Triggering Setpoints .
TIMERS	Interval Timers (setpoints triggers only)
TIMER 1:16	Interval timer 1-16
DIGITAL INPUTS	Digital Inputs
DI1:48	Digital input status DI1:DI48
PULSE INPUTS	Pulse Inputs (setpoints triggers only)
DI1:48	Transition pulse on a digital input DI1:DI48
RELAYS	Relays
RO1:16	Relay status RO1:RO2
COUNTERS	Pulse Counters
COUNTER 1:32	Pulse counter 1-32
TIME	Time/Date Parameters (setpoints triggers only)
DATE	Date (DDMMYY)
TIME	Time (HHMMSS)
DAY OF WEEK	Day of week
YEAR	Year
MONTH	Month
DAY OF MONTH	Day of month
HOURS	Hours
MINUTES	Minutes
SECONDS	Seconds
MINUTE INTERVAL	Minute interval: 1-5, 10, 15, 20, 30, 60 min
SYMM COMP	Symmetrical Components
V PSEQ	Positive-sequence voltage
V NSEQ	Negative-sequence voltage
V ZSEQ	Zero-sequence voltage

Designation	Description
V NSEQ UNB%	Negative-sequence voltage unbalance
V ZSEQ UNB%	Zero-sequence voltage unbalance
I PSEQ	Positive-sequence current
I NSEQ	Negative-sequence current
I ZSEQ	Zero-sequence current
I NSEQ UNB%	Negative-sequence current unbalance
I ZSEQ UNB%	Zero-sequence current unbalance
RMS (1/2 cycle)	1/2-Cycle Values
V1	V1 voltage
V2	V2 voltage
V3	V3 voltage
V4	V4 voltage
V12	V12 voltage
V23	V23 voltage
V31	V31 voltage
I1	I1 current
I2	I2 current
I3	I3 current
I4	I4 current
In	In current
I1x	I1x current
I2x	I2x current
I3x	I3x current
I4x	I4x current
Inx	Inx current
V ZERO-SEQ	Zero-sequence voltage
I ZERO-SEQ	Zero-sequence current
Ix ZERO-SEQ	Ix Zero-sequence current
V UNB%	Voltage unbalance
I UNB%	Current unbalance
Ix UNB%	Ix current unbalance
VDC	DC voltage
RT PHASE	1-Cycle Phase Values
V1	V1 Voltage
V2	V2 Voltage
V3	V3 Voltage
I1	I1 Current
I2	I2 Current
I3	I3 Current
kW L1	kW L1
kW L2	kW L2
kW L3	kW L3
kvar L1	kvar L1
kvar L2	kvar L2
kvar L3	kvar L3
kVA L1	kVA L1
kVA L2	kVA L2
kVA L3	kVA L3
PF L1	Power factor L1
PF L2	Power factor L2
PF L3	Power factor L3
V1 THD	V1/V12 Voltage THD ¹
V2 THD	V2/V23 Voltage THD ¹
V3 THD	V3/V31 Voltage THD ¹
I1 THD	I1 Current THD
I2 THD	I2 Current THD
I3 THD	I3 Current THD
I1 KF	I1 K-Factor
I2 KF	I2 K-Factor
I3 KF	I3 K-Factor
I1 TDD	I1 Current TDD
I2 TDD	I2 Current TDD
I3 TDD	I3 Current TDD
V12	V12 Voltage
V23	V23 Voltage
V31	V31 Voltage
I1x	I1x Current
I2x	I2x Current

Designation	Description
I3x	I3x Current
RT LOW	1-Cycle Low Values on any Phase
V LOW	Low L-N voltage
I LOW	Low current
kW LOW	Low kW
kvar LOW	Low kvar
kVA LOW	Low kVA
PF LAG LOW	Low lagging PF
PF LEAD LOW	Low leading PF
THD LOW	Low voltage THD ¹
V THD LOW	Low current THD
KF LOW	Low K-Factor
I TDD LOW	Low current TDD
V L-L LOW	Low L-L voltage
V THD/I LOW	Low voltage interharmonics THD ¹
I THD/I LOW	Low current interharmonics THD
RT HIGH	1-Cycle High Values on any Phase
V HIGH	High L-N voltage
I HIGH	High current
kW HIGH	High kW
kvar HIGH	High kvar
kVA HIGH	High kVA
PF LAG HIGH	High PF Lag
PF LEAD HIGH	High PF Lead
THD HIGH	High voltage THD ¹
V THD HIGH	High current THD
KF HIGH	High K-Factor
I TDD HIGH	High current TDD
V L-L HIGH	High L-L voltage
V THD/I HIGH	High voltage interharmonics THD ¹
I THD/I HIGH	High current interharmonics THD
RT TOTAL	1-Cycle Total Values
kW	Total kW
kvar	Total kvar
kVA	Total kVA
PF	Total PF
PF LAG	Total PF lag
PF LEAD	Total PF lead
kW IMP	Total kW import
kW EXP	Total kW export
kvar IMP	Total kvar import
kvar EXP	Total kvar export
V AVG	3-phase average L-N voltage
V LL AVG	3-phase average L-L voltage
I AVG	3-phase average current
RT AUX	1-Cycle Auxiliary Values
I4	I4 current
In	In current
FREQ	Frequency
V UNB%	Voltage unbalance
I UNB%	Current unbalance
VDC	DC voltage
V4	V4 voltage
I4x	I4x current
AVR PHASE	1-Second Phase Values
V1	V1 Voltage
V2	V2 Voltage
V3	V3 Voltage
I1	I1 Current
I2	I2 Current
I3	I3 Current
kW L1	kW L1
kW L2	kW L2
kW L3	kW L3
kvar L1	kvar L1
kvar L2	kvar L2
kvar L3	kvar L3
kVA L1	kVA L1

Designation	Description
kVA L2	kVA L2
kVA L3	kVA L3
PF L1	Power factor L1
PF L2	Power factor L2
PF L3	Power factor L3
V1 THD	V1/V12 Voltage THD ¹
V2 THD	V2/V23 Voltage THD ¹
V3 THD	V3/V31 Voltage THD ¹
I1 THD	I1 Current THD
I2 THD	I2 Current THD
I3 THD	I3 Current THD
I1 KF	I1 K-Factor
I2 KF	I2 K-Factor
I3 KF	I3 K-Factor
I1 TDD	I1 Current TDD
I2 TDD	I2 Current TDD
I3 TDD	I3 Current TDD
V12	V12 Voltage
V23	V23 Voltage
V31	V31 Voltage
V1x	V1x phase-to-ground voltage
V2x	V2x phase-to-ground voltage
V3x	V3x phase-to-ground voltage
I1x	I1x Current
I2x	I2x Current
I3x	I3x Current
AVR LOW	1-Second Low Values on any Phase
V LOW	Low L-N voltage
I LOW	Low current
kW LOW	Low kW
kvar LOW	Low kvar
kVA LOW	Low kVA
PF LAG LOW	Low lagging PF
PF LEAD LOW	Low leading PF
THD LOW	Low voltage THD ¹
V THD LOW	Low current THD
KF LOW	Low K-Factor
I TDD LOW	Low current TDD
V L-L LOW	Low L-L voltage
V THD/I LOW	Low voltage interharmonics THD ¹
I THD/I LOW	Low current interharmonics THD
AVR HIGH	1-Second High Values on any Phase
V HIGH	High L-N voltage
I HIGH	High current
kW HIGH	High kW
kvar HIGH	High kvar
kVA HIGH	High kVA
PF LAG HIGH	High PF Lag
PF LEAD HIGH	High PF Lead
THD HIGH	High voltage THD ¹
V THD HIGH	High current THD
KF HIGH	High K-Factor
I TDD HIGH	High current TDD
V L-L HIGH	High L-L voltage
V THD/I HIGH	High voltage interharmonics THD ¹
I THD/I HIGH	High current interharmonics THD
AVR TOTAL	1-Second Total Values
kW	Total kW
kvar	Total kvar
kVA	Total kVA
PF	Total PF
PF LAG	Total PF lag
PF LEAD	Total PF lead
kW IMP	Total kW import
kW EXP	Total kW export
kvar IMP	Total kvar import
kvar EXP	Total kvar export

Designation	Description
V AVG	3-phase average L-N voltage
V LL AVG	3-phase average L-L voltage
I AVG	3-phase average current
AVR AUX	1-Second Auxiliary Values
I4	I4 current
In	In current
FREQ	Frequency
FREQ3	Frequency with 3 decimal points
V UNB%	Voltage unbalance
I UNB%	Current unbalance
VDC	DC voltage
V4	V4 voltage
V4x	V4x neutral-to-ground voltage
I4x	I4x current
RMS (0.2 sec)	0.2-Second RMS Values
V1	V1 voltage
V2	V2 voltage
V3	V3 voltage
V4	V4 voltage
V12	V12 voltage
V23	V23 voltage
V31	V31 voltage
I1	I1 current
I2	I2 current
I3	I3 current
I4	I4 current
In	In current
I1x	I1x current
I2x	I2x current
I3x	I3x current
I4x	I4x current
Inx	Inx current
V ZERO-SEQ	Zero-sequence voltage
I ZERO-SEQ	Zero-sequence current
Ix ZERO-SEQ	Ix Zero-sequence current
V UNB%	Voltage unbalance
I UNB%	Current unbalance
Ix UNB%	Ix current unbalance
VDC	DC voltage
FREQ	Frequency
V PSEC	Positive-sequence Voltage
V ZSEC UNB%	Zero-sequence Voltage Unbalance
RMS (3 sec)	3-Second RMS Values
V1	V1 voltage
V2	V2 voltage
V3	V3 voltage
V4	V4 voltage
V12	V12 voltage
V23	V23 voltage
V31	V31 voltage
I1	I1 current
I2	I2 current
I3	I3 current
I4	I4 current
In	In current
I1x	I1x current
I2x	I2x current
I3x	I3x current
I4x	I4x current
Inx	Inx current
V ZERO-SEQ	Zero-sequence voltage
I ZERO-SEQ	Zero-sequence current
Ix ZERO-SEQ	Ix Zero-sequence current
V UNB%	Voltage unbalance
I UNB%	Current unbalance
Ix UNB%	Ix current unbalance
VDC	DC voltage
FREQ	Frequency

Designation	Description
V PSEC	Positive-sequence Voltage
V ZSEC UNB%	Zero-sequence Voltage Unbalance
RMS (10 min)	10-Minute RMS Values
V1	V1 voltage
V2	V2 voltage
V3	V3 voltage
V4	V4 voltage
V12	V12 voltage
V23	V23 voltage
V31	V31 voltage
I1	I1 current
I2	I2 current
I3	I3 current
I4	I4 current
In	In current
I1x	I1x current
I2x	I2x current
I3x	I3x current
I4x	I4x current
Inx	Inx current
V ZERO-SEQ	Zero-sequence voltage
I ZERO-SEQ	Zero-sequence current
Ix ZERO-SEQ	Ix Zero-sequence current
V UNB%	Voltage unbalance
I UNB%	Current unbalance
Ix UNB%	Ix current unbalance
VDC	DC voltage
FREQ	Frequency
V PSEC	Positive-sequence Voltage
V ZSEC UNB%	Zero-sequence Voltage Unbalance
RMS (2 hour)	2-Hour RMS Values
V1	V1 voltage
V2	V2 voltage
V3	V3 voltage
V4	V4 voltage
V12	V12 voltage
V23	V23 voltage
V31	V31 voltage
I1	I1 current
I2	I2 current
I3	I3 current
I4	I4 current
In	In current
I1x	I1x current
I2x	I2x current
I3x	I3x current
I4x	I4x current
Inx	Inx current
V ZERO-SEQ	Zero-sequence voltage
I ZERO-SEQ	Zero-sequence current
Ix ZERO-SEQ	Ix Zero-sequence current
V UNB%	Voltage unbalance
I UNB%	Current unbalance
Ix UNB%	Ix current unbalance
VDC	DC voltage
FREQ	Frequency
V PSEC	Positive-sequence Voltage
V ZSEC UNB%	Zero-sequence Voltage Unbalance
HRM TOT (0.2 sec)	0.2-Second Total Harmonics
V1 THD	V1/V12 THD ¹
V2 THD	V2/V23 THD ¹
V3 THD	V3/V31 THD ¹
V4 THD	V4 THD
I1 THD	I1 THD
I2 THD	I2 THD
I3 THD	I3 THD
I4 THD	I4 THD
V1 THD/I	V1/V12 interharmonics THD ¹

Designation	Description
V2 THD/I	V2/V23 interharmonics THD ¹
V3 THD/I	V3/V31 interharmonics THD ¹
V4 THD/I	V4 interharmonics THD
I1 THD/I	I1 interharmonics THD
I2 THD/I	I2 interharmonics THD
I3 THD/I	I3 interharmonics THD
I4 THD/I	I4 interharmonics THD
I1 TDD	I1 TDD
I2 TDD	I2 TDD
I3 TDD	I3 TDD
I4 TDD	I4 TDD
I1 KF	I1 K-Factor
I2 KF	I2 K-Factor
I3 KF	I3 K-Factor
I4 KF	I4 K-Factor
V1 CF	V1/V12 Crest Factor ¹
V2 CF	V2/V23 Crest Factor ¹
V3 CF	V3/V31 Crest Factor ¹
V4 CF	V4 Crest Factor
I1 CF	I1 Crest Factor
I2 CF	I2 Crest Factor
I3 CF	I3 Crest Factor
I4 CF	I4 Crest Factor
HRM TOT (3 sec)	3-Second Total Harmonics
V1 THD	V1/V12 THD ¹
V2 THD	V2/V23 THD ¹
V3 THD	V3/V31 THD ¹
V4 THD	V4 THD
I1 THD	I1 THD
I2 THD	I2 THD
I3 THD	I3 THD
I4 THD	I4 THD
V1 THD/I	V1/V12 interharmonics THD ¹
V2 THD/I	V2/V23 interharmonics THD ¹
V3 THD/I	V3/V31 interharmonics THD ¹
V4 THD/I	V4 interharmonics THD
I1 THD/I	I1 interharmonics THD
I2 THD/I	I2 interharmonics THD
I3 THD/I	I3 interharmonics THD
I4 THD/I	I4 interharmonics THD
I1 TDD	I1 TDD
I2 TDD	I2 TDD
I3 TDD	I3 TDD
I4 TDD	I4 TDD
I1 KF	I1 K-Factor
I2 KF	I2 K-Factor
I3 KF	I3 K-Factor
I4 KF	I4 K-Factor
V1 CF	V1/V12 Crest Factor ¹
V2 CF	V2/V23 Crest Factor ¹
V3 CF	V3/V31 Crest Factor ¹
V4 CF	V4 Crest Factor
I1 CF	I1 Crest Factor
I2 CF	I2 Crest Factor
I3 CF	I3 Crest Factor
I4 CF	I4 Crest Factor
HRM TOT (10 min)	10-Minute Total Harmonics
V1 THD	V1/V12 THD ¹
V2 THD	V2/V23 THD ¹
V3 THD	V3/V31 THD ¹
V4 THD	V4 THD
I1 THD	I1 THD
I2 THD	I2 THD
I3 THD	I3 THD
I4 THD	I4 THD

APPENDIX C PARAMETERS FOR MONITORING AND DATA LOGGING

Designation	Description
V1 THD/I	V1/V12 interharmonics THD ¹
V2 THD/I	V2/V23 interharmonics THD ¹
V3 THD/I	V3/V31 interharmonics THD ¹
V4 THD/I	V4 interharmonics THD
I1 THD/I	I1 interharmonics THD
I2 THD/I	I2 interharmonics THD
I3 THD/I	I3 interharmonics THD
I4 THD/I	I4 interharmonics THD
I1 TDD	I1 TDD
I2 TDD	I2 TDD
I3 TDD	I3 TDD
I4 TDD	I4 TDD
I1 KF	I1 K-Factor
I2 KF	I2 K-Factor
I3 KF	I3 K-Factor
I4 KF	I4 K-Factor
V1 CF	V1/V12 Crest Factor ¹
V2 CF	V2/V23 Crest Factor ¹
V3 CF	V3/V31 Crest Factor ¹
V4 CF	V4 Crest Factor
I1 CF	I1 Crest Factor
I2 CF	I2 Crest Factor
I3 CF	I3 Crest Factor
I4 CF	I4 Crest Factor
HRM TOT (2 hour)	2-Hour Total Harmonics
V1 THD	V1/V12 THD ¹
V2 THD	V2/V23 THD ¹
V3 THD	V3/V31 THD ¹
V4 THD	V4 THD
I1 THD	I1 THD
I2 THD	I2 THD
I3 THD	I3 THD
I4 THD	I4 THD
V1 THD/I	V1/V12 interharmonics THD ¹
V2 THD/I	V2/V23 interharmonics THD ¹
V3 THD/I	V3/V31 interharmonics THD ¹
V4 THD/I	V4 interharmonics THD
I1 THD/I	I1 interharmonics THD
I2 THD/I	I2 interharmonics THD
I3 THD/I	I3 interharmonics THD
I4 THD/I	I4 interharmonics THD
I1 TDD	I1 TDD
I2 TDD	I2 TDD
I3 TDD	I3 TDD
I4 TDD	I4 TDD
I1 KF	I1 K-Factor
I2 KF	I2 K-Factor
I3 KF	I3 K-Factor
I4 KF	I4 K-Factor
V1 CF	V1/V12 Crest Factor ¹
V2 CF	V2/V23 Crest Factor ¹
V3 CF	V3/V31 Crest Factor ¹
V4 CF	V4 Crest Factor
I1 CF	I1 Crest Factor
I2 CF	I2 Crest Factor
I3 CF	I3 Crest Factor
I4 CF	I4 Crest Factor
PHASORS	Phasors
V1 Mag	V1/V12 Voltage magnitude ¹
V2 Mag	V2/V23 Voltage magnitude ¹
V3 Mag	V3/V31 Voltage magnitude ¹
V4 Mag	V4 Voltage magnitude
I1 Mag	I1 Current magnitude
I2 Mag	I2 Current magnitude
I3 Mag	I3 Current magnitude

Designation	Description
I4 Mag	I4 Current magnitude
V1 Ang	V1/V12 Voltage angle ¹
V2 Ang	V2/V23 Voltage angle ¹
V3 Ang	V3/V31 Voltage angle ¹
V4 Ang	V4 Voltage angle
I1 Ang	I1 Current angle
I2 Ang	I2 Current angle
I3 Ang	I3 Current angle
I4 Ang	I4 Current angle
I1x Mag	I1x Current magnitude
I2x Mag	I2x Current magnitude
I3x Mag	I3x Current magnitude
I4x Mag	I4x Current magnitude
I1x Ang	I1x Current angle
I2x Ang	I2x Current angle
I3x Ang	I3x Current angle
I4x Ang	I4x Current angle
DEMANDS	Present Demands
V1 DMD	V1/V12 Volt demand ¹
V2 DMD	V2/V23 Volt demand ¹
V3 DMD	V3/V31 Volt demand ¹
I1 DMD	I1 Ampere demand
I2 DMD	I2 Ampere demand
I3 DMD	I3 Ampere demand
kW IMP BD	kW import block demand
kvar IMP BD	kvar import block demand
kVA BD	kVA block demand
kW IMP SD	kW import sliding window demand
kvar IMP SD	kvar import sliding window demand
kVA SD	kVA sliding window demand
kW IMP ACC DMD	kW import accumulated demand
kvar IMP ACC DMD	kvar import accumulated demand
kVA ACC DMD	kVA accumulated demand
kW IMP PRD DMD	kW import predicted sliding window demand
kvar IMP PRD DMD	kvar import predicted sliding window demand
kVA PRD DMD	kVA predicted sliding window demand
PF IMP@kVA MXDMD	PF (import) at Maximum kVA sliding window demand
kW EXP BD	kW export block demand
kvar EXP BD	kvar export block demand
kW EXP SD	kW export sliding window demand
kvar EXP SD	kvar export sliding window demand
kW EXP ACC DMD	kW export accumulated demand
kvar EXP ACC DMD	kvar export accumulated demand
kW EXP PRD DMD	kW export predicted sliding window demand
kvar EXP PRD DMD	kvar export predicted sliding window demand
V4 DMD	V4 Volt demand
I4 DMD	I4 Ampere demand
In DMD	In Ampere demand
HRM DMD	Present Harmonic Demands
V1 THD DMD	V1/V12 THD demand ¹
V2 THD DMD	V2/V23 THD demand ¹
V3 THD DMD	V3/V31 THD demand ¹
V4 THD DMD	V4 THD demand
I1 THD DMD	I1 THD demand
I2 THD DMD	I2 THD demand
I3 THD DMD	I3 THD demand
I4 THD DMD	I4 THD demand
I1 TDD DMD	I1 TDD demand
I2 TDD DMD	I2 TDD demand
I3 TDD DMD	I3 TDD demand
I4 TDD DMD	I4 TDD demand
SUMM ACC DMD	Summary (TOU Total) Accumulated Demands
SUM REG1 ACC DMD	Summary register #1 demand
SUM REG2 ACC DMD	Summary register #2 demand
...	...
SUM REG16 ACC DMD	Summary register #16 demand
SUMM BLK DMD	Summary (TOU Total) Block Demands

Designation	Description
SUM REG1 BLK DMD	Summary register #1 demand
SUM REG2 BLK DMD	Summary register #2 demand
...	...
SUM REG16 BLK DMD	Summary register #16 demand
SUMM SW DMD	Summary (TOU Total) Sliding Demands
SUM REG1 SW DMD	Summary register #1 demand
SUM REG2 SW DMD	Summary register #2 demand
...	...
SUM REG16 SW DMD	Summary register #16 demand
ENERGY	Total Energy
kWh IMPORT	kWh import
kWh EXPORT	kWh export
kWh NET	kWh net
kWh TOTAL	kWh total
kvarh IMPORT	kvarh import
kvarh EXPORT	kvarh export
kvarh NET	kvarh net
kvarh TOTAL	kvarh total
kVAh TOTAL	kVAh total
Vh	Volt-hours
Ah	Ampere-hours
SUMMARY REGS	Summary (TOU Total) Energy Registers
SUM REG1	Summary energy register #1
SUM REG2	Summary energy register #2
...	...
SUM REG16	Summary energy register #16
%HD V1	V1/V12 Harmonic Distortions 1
V1 %HD01	H01 Harmonic distortion
V1 %HD02	H02 Harmonic distortion
...	...
V1 %HD63	H63 Harmonic distortion
%HD V2	V2/V23 Harmonic Distortions 1
V2 %HD01	H01 Harmonic distortion
V2 %HD02	H02 Harmonic distortion
...	...
V2 %HD63	H63 Harmonic distortion
%HD V3	V3/V31 Harmonic Distortions 1
V3 %HD01	H01 Harmonic distortion
V3 %HD02	H02 Harmonic distortion
...	...
V3 %HD63	H63 Harmonic distortion
%HD V4	V4 Harmonic Distortions
V4 %HD01	H01 Harmonic distortion
V4 %HD02	H02 Harmonic distortion
...	...
V4 %HD63	H63 Harmonic distortion
%HD I1	I1 Harmonic Distortions
I1 %HD01	H01 Harmonic distortion
I1 %HD02	H02 Harmonic distortion
...	...
I1 %HD63	H63 Harmonic distortion
%HD I2	I2 Harmonic Distortions
I2 %HD01	H01 Harmonic distortion
I2 %HD02	H02 Harmonic distortion
...	...
I2 %HD63	H63 Harmonic distortion
%HD I3	I3 Harmonic Distortions
I3 %HD01	H01 Harmonic distortion
I3 %HD02	H02 Harmonic distortion
...	...
I3 %HD63	H63 Harmonic distortion
%HD I4	I4 Harmonic Distortions
I4 %HD01	H01 Harmonic distortion
I4 %HD02	H02 Harmonic distortion
...	...
I4 %HD63	H63 Harmonic distortion
INTHRM %HD V1	V1/V12 Interharmonic Distortions 1
V1 %IHD01	H01 Interharmonic distortion

Designation	Description
V1 %IHD02	H02 Interharmonic distortion
...	...
V1 %IHD63	H63 Interharmonic distortion
INTHRM %HD V2	V2/V23 Interharmonic Distortions 1
V2 % IHD01	H01 Interharmonic distortion
V2 % IHD02	H02 Interharmonic distortion
...	...
V2 % IHD63	H63 Interharmonic distortion
INTHRM %HD V3	V3/V31 Interharmonic Distortions 1
V3 % IHD01	H01 Interharmonic distortion
V3 % IHD02	H02 Interharmonic distortion
...	...
V3 % IHD63	H63 Interharmonic distortion
ANG V1	V1/V12 Harmonic Angles
V1 H01 ANG	H01 Harmonic angle
V1 H02 ANG	H02 Harmonic angle
...	...
V1 H63 ANG	H63 Harmonic angle
ANG V2	V2/V23 Harmonic Angles
V2 H01 ANG	H01 Harmonic angle
V2 H02 ANG	H02 Harmonic angle
...	...
V2 H63 ANG	H63 Harmonic angle
ANG V3	V3/V31 Harmonic Angles
V3 H01 ANG	H01 Harmonic angle
V3 H02 ANG	H02 Harmonic angle
...	...
V3 H63 ANG	H63 Harmonic angle
ANG V4	V4 Harmonic Angles
V4 H01 ANG	H01 Harmonic angle
V4 H02 ANG	H02 Harmonic angle
...	...
V4 H63 ANG	H63 Harmonic angle
ANG I1	I1 Harmonic Angles
I1 H01 ANG	H01 Harmonic angle
I1 H02 ANG	H02 Harmonic angle
...	...
I1 H63 ANG	H63 Harmonic angle
ANG I2	I2 Harmonic Angles
I2 H01 ANG	H01 Harmonic angle
I2 H02 ANG	H02 Harmonic angle
...	...
I2 H63 ANG	H63 Harmonic angle
ANG I3	I3 Harmonic Angles
I3 H01 ANG	H01 Harmonic angle
I3 H02 ANG	H02 Harmonic angle
...	...
I3 H63 ANG	H63 Harmonic angle
ANG I4	I4 Harmonic Angles
I4 H01 ANG	H01 Harmonic angle
I4 H02 ANG	H02 Harmonic angle
...	...
I4 H63 ANG	H63 Harmonic angle
HRM V1	V1/V12 Harmonic Voltages (odd harmonics) 1
V1 H01	H01 Harmonic voltage
V1 H03	H03 Harmonic voltage
...	...
V1 H63	H63 Harmonic voltage
HRM V2	V2/V23 Harmonic Voltages (odd harmonics) 1
V2 H01	H01 Harmonic voltage
V2 H03	H03 Harmonic voltage
...	...
V2 H63	H63 Harmonic voltage
HRM V3	V3/V31 Harmonic Voltages (odd harmonics) 1
V3 H01	H01 Harmonic voltage
V3 H03	H03 Harmonic voltage
...	...
V3 H63	H63 Harmonic voltage

Designation	Description
HRM V4	V4 Harmonic Voltages (odd harmonics)
V4 H01	H01 Harmonic voltage
V4 H03	H03 Harmonic voltage
...	...
V4 H63	H63 Harmonic voltage
HRM I1	I1 Harmonic Currents (odd harmonics)
I1 H01	H01 Harmonic current
I1 H03	H03 Harmonic current
...	...
I1 H63	H63 Harmonic current
HRM I2	I2 Harmonic Currents (odd harmonics)
I2 H01	H01 Harmonic current
I2 H03	H03 Harmonic current
...	...
I2 H63	H63 Harmonic current
HRM I3	I3 Harmonic Currents (odd harmonics)
I3 H01	H01 Harmonic current
I3 H03	H03 Harmonic current
...	...
I3 H63	H63 Harmonic current
HRM I4	I4 Harmonic Currents (odd harmonics)
I4 H01	H01 Harmonic current
I4 H03	H03 Harmonic current
...	...
I4 H63	H63 Harmonic current
HRM kW	Total Harmonic kW (odd harmonics)
kW H01	H01 Harmonic kW
kW H03	H03 Harmonic kW
...	...
kW H63	H63 Harmonic kW
HRM kvar	Total Harmonic kvar (odd harmonics)
kvar H01	H01 Harmonic kvar
kvar H03	H03 Harmonic kvar
...	...
kvar H63	H63 Harmonic kvar
HRM PF	Total Harmonic PF (odd harmonics)
PF H01	H01 Harmonic PF
PF H03	H03 Harmonic PF
...	...
PF H63	H63 Harmonic PF
H1 PHASE	Fundamental Phase Values
V1 H01	V1/V12 Voltage ¹
V2 H01	V2/V23 Voltage ¹
V3 H01	V3/V31 Voltage ¹
I1 H01	I1 Current
I2 H01	I2 Current
I3 H01	I3 Current
kW L1 H01	kW L1
kW L2 H01	kW L2
kW L3 H01	kW L3
kvar L1 H01	kvar L1
kvar L2 H01	kvar L2
kvar L3 H01	kvar L3
kVA L1 H01	kVA L1
kVA L2 H01	kVA L2
kVA L3 H01	kVA L3
PF L1 H01	Power factor L1
PF L2 H01	Power factor L2
PF L3 H01	Power factor L3
HRM TOT POW	Fundamental Total Power Values
kW H01	Total fundamental kW
kvar H01	Total fundamental kvar
kVA H01	Total fundamental kVA
PF H01	Total fundamental PF
FLICKER	Flicker 1
V1 Pst	V1 short-term (10 min) flicker severity
V2 Pst	V2 short-term (10 min) flicker severity
V3 Pst	V3 short-term (10 min) flicker severity

Designation	Description
V1 Plt	V1 long-term (2 hours) flicker severity
V2 Plt	V2 long-term (2 hours) flicker severity
V3 Plt	V3 long-term (2 hours) flicker severity
MIN PHASE	Minimum 1-Cycle Phase Values
V1 MIN	V1 voltage
V2 MIN	V2 voltage
V3 MIN	V3 voltage
I1 MIN	I1 current
I2 MIN	I2 current
I3 MIN	I3 current
kW L1 MIN	kW L1
kW L2 MIN	kW L2
kW L3 MIN	kW L3
kvar L1 MIN	kvar L1
kvar L2 MIN	kvar L2
kvar L3 MIN	kvar L3
kVA L1 MIN	kVA L1
kVA L2 MIN	kVA L2
kVA L3 MIN	kVA L3
PF L1 MIN	Power factor L1
PF L2 MIN	Power factor L2
PF L3 MIN	Power factor L3
V1 THD MIN	V1 voltage THD
V2 THD MIN	V2 voltage THD
V3 THD MIN	V3 voltage THD
I1 THD MIN	I1 current THD
I2 THD MIN	I2 current THD
I3 THD MIN	I3 current THD
I1 KF MIN	I1 K-Factor
I2 KF MIN	I2 K-Factor
I3 KF MIN	I3 K-Factor
I1 TDD MIN	I1 current TDD
I2 TDD MIN	I2 current TDD
I3 TDD MIN	I3 current TDD
V12 MIN	V12 voltage
V23 MIN	V23 voltage
V31 MIN	V31 voltage
I1x MIN	I1x current
I2x MIN	I2x current
I3x MIN	I3x current
MIN TOTAL	Minimum 1-Cycle Total Values
kW MIN	Total kW
kvar MIN	Total kvar
kVA MIN	Total kVA
PF MIN	Total PF
PF LAG MIN	Total PF lag
PF LEAD MIN	Total PF lead
MIN AUX	Minimum 1-Cycle Auxiliary Values
I4 MIN	I4 current
In MIN	In current
FREQ MIN	Frequency
V UNB% MIN	Voltage unbalance
I UNB% MIN	Current unbalance
VDC MIN	DC voltage
V4 MIN	V4 voltage
I4x MIN	I4x current
V4 THD MIN	V4 THD
I4 THD MIN	I4 THD
I4 TDD MIN	I4 TDD
MIN PRG	Programmable Min/Max Minimum Registers
PROG REG1 MIN	Min/Max Register #1
PROG REG1 MIN	Min/Max Register #2
...	...
PROG REG16 MIN	Min/Max Register #16
MAX PHASE	Maximum 1-Cycle Phase Values
V1 MAX	V1 voltage
V2 MAX	V2 voltage
V3 MAX	V3 voltage

Designation	Description
I1 MAX	I1 current
I2 MAX	I2 current
I3 MAX	I3 current
kW L1 MAX	kW L1
kW L2 MAX	kW L2
kW L3 MAX	kW L3
kvar L1 MAX	kvar L1
kvar L2 MAX	kvar L2
kvar L3 MAX	kvar L3
kVA L1 MAX	kVA L1
kVA L2 MAX	kVA L2
kVA L3 MAX	kVA L3
PF L1 MAX	Power factor L1
PF L2 MAX	Power factor L2
PF L3 MAX	Power factor L3
V1 THD MAX	V1 voltage THD
V2 THD MAX	V2 voltage THD
V3 THD MAX	V3 voltage THD
I1 THD MAX	I1 current THD
I2 THD MAX	I2 current THD
I3 THD MAX	I3 current THD
I1 KF MAX	I1 K-Factor
I2 KF MAX	I2 K-Factor
I3 KF MAX	I3 K-Factor
I1 TDD MAX	I1 current TDD
I2 TDD MAX	I2 current TDD
I3 TDD MAX	I3 current TDD
V12 MAX	V12 voltage
V23 MAX	V23 voltage
V31 MAX	V31 voltage
I1x MAX	I1x current
I2x MAX	I2x current
I3x MAX	I3x current
MAX TOTAL	Maximum 1-Cycle Total Values
kW MAX	Total kW
kvar MAX	Total kvar
kVA MAX	Total kVA
PF MAX	Total PF
PF LAG MAX	Total PF lag
PF LEAD MAX	Total PF lead
MAX AUX	Maximum 1-Cycle Auxiliary Values
I4 MAX	I4 current
In MAX	In current
FREQ MAX	Frequency
V UNB% MAX	Voltage unbalance
I UNB% MAX	Current unbalance
VDC MAX	DC voltage
V4 MAX	V4 voltage
I4x MAX	I4x current
V4 THD MAX	V4 THD
I4 THD MAX	I4 THD
I4 TDD MAX	I4 TDD
MAX DMD	Maximum Demands
V1 DMD MAX	V1/V12 Maximum volt demand ¹
V2 DMD MAX	V2/V23 Maximum volt demand ¹
V3 DMD MAX	V3/V31 Maximum volt demand ¹
I1 DMD MAX	I1 Maximum ampere demand
I2 DMD MAX	I2 Maximum ampere demand
I3 DMD MAX	I3 Maximum ampere demand
kW IMP SD MAX	Maximum kW import sliding window demand
kvar IMP SD MAX	Maximum kvar import sliding window demand
kVA IMP SD MAX	Maximum kVA sliding window demand
kvar EXP SD MAX	Maximum kW export sliding window demand
kvar EXP SD MAX	Maximum kvar export sliding window demand
V4 DMD MAX	V4 Maximum volt demand
I4 DMD MAX	I4 Maximum ampere demand
In DMD MAX	In Maximum ampere demand
MAX HRM DMD	Maximum Harmonic Demands

Designation	Description
V1 THD DMD MAX	V1/V12 THD demand ¹
V2 THD DMD MAX	V2/V23 THD demand ¹
V3 THD DMD MAX	V3/V31 THD demand ¹
V4 THD DMD MAX	V4 THD demand
I1 THD DMD MAX	I1 THD demand
I2 THD DMD MAX	I2 THD demand
I3 THD DMD MAX	I3 THD demand
I4 THD DMD MAX	I4 THD demand
I1 TDD DMD MAX	I1 TDD demand
I2 TDD DMD MAX	I2 TDD demand
I3 TDD DMD MAX	I3 TDD demand
I4 TDD DMD MAX	I4 TDD demand
MAX SUMMARY DMD	Maximum Summary (TOU Total) Demands
SUM REG1 DMD MAX	Summary register #1 maximum demand
SUM REG2 DMD MAX	Summary register #2 maximum demand
...	...
SUM REG16 DMD MAX	Summary register #16 maximum demand
MAX PRG	Programmable Min/Max Maximum Registers
PROG REG1 MAX	Min/Max Register #1
PROG REG2 MAX	Min/Max Register #2
...	...
PROG REG16 MAX	Min/Max Register #16
ANALOG INPUTS	Scaled Analog Inputs (Engineering Units)
AI1	Analog input AI1
AI2	Analog input AI2
...	...
AI16	Analog input AI16
AI RAW	Raw Analog Inputs (A/D Units)
AI1 RAW	Analog input AI1
AI2 RAW	Analog input AI2
...	...
AI16 RAW	Analog input AI16
AO RAW	Raw Analog Outputs (A/D Units)
AO1	Analog output AO1
AO2	Analog output AO2
...	...
AO16	Analog output AO16
TOU PRMS	TOU Parameters
ACTIVE TARIFF	Active TOU tariff
ACTIVE PROFILE	Active TOU profile
TOU REG1	TOU Energy Register #1
TOU REG1 TRF1	Tariff #1 register
TOU REG1 TRF2	Tariff #2 register
...	...
TOU REG1 TRF16	Tariff #16 register
TOU REG2	TOU Energy Register #2
TOU REG2 TRF1	Tariff #1 register
TOU REG2 TRF2	Tariff #2 register
...	...
TOU REG2 TRF16	Tariff #16 register
TOU REG3	TOU Energy Register #3
TOU REG3 TRF1	Tariff #1 register
TOU REG3 TRF2	Tariff #2 register
...	...
TOU REG3 TRF16	Tariff #16 register
TOU REG4	TOU Energy Register #4
TOU REG4 TRF1	Tariff #1 register
TOU REG4 TRF2	Tariff #2 register
...	...
TOU REG4 TRF16	Tariff #16 register
TOU REG5	TOU Energy Register #5
TOU REG5 TRF1	Tariff #1 register
TOU REG5 TRF2	Tariff #2 register
...	...
TOU REG5 TRF16	Tariff #16 register
TOU REG6	TOU Energy Register #6
TOU REG6 TRF1	Tariff #1 register
TOU REG6 TRF2	Tariff #2 register

Designation	Description
...	...
TOU REG6 TRF16	Tariff #16 register
TOU REG7	TOU Energy Register #7
TOU REG7 TRF1	Tariff #1 register
TOU REG7 TRF2	Tariff #2 register
...	...
TOU REG7 TRF16	Tariff #16 register
TOU REG8	TOU Energy Register #8
TOU REG8 TRF1	Tariff #1 register
TOU REG8 TRF2	Tariff #2 register
...	...
TOU REG8 TRF16	Tariff #16 register
TOU REG9	TOU Energy Register #9
TOU REG9 TRF1	Tariff #1 register
TOU REG9 TRF2	Tariff #2 register
...	...
TOU REG9 TRF16	Tariff #16 register
TOU REG10	TOU Energy Register #10
TOU REG10 TRF1	Tariff #1 register
TOU REG10 TRF2	Tariff #2 register
...	...
TOU REG10 TRF16	Tariff #16 register
TOU REG11	TOU Energy Register #11
TOU REG11 TRF1	Tariff #1 register
TOU REG11 TRF2	Tariff #2 register
...	...
TOU REG11 TRF16	Tariff #16 register
TOU REG12	TOU Energy Register #12
TOU REG12 TRF1	Tariff #1 register
TOU REG12 TRF2	Tariff #2 register
...	...
TOU REG12 TRF16	Tariff #16 register
TOU REG13	TOU Energy Register #13
TOU REG13 TRF1	Tariff #1 register
TOU REG13 TRF2	Tariff #2 register
...	...
TOU REG13 TRF16	Tariff #16 register
TOU REG14	TOU Energy Register #14
TOU REG14 TRF1	Tariff #1 register
TOU REG14 TRF2	Tariff #2 register
...	...
TOU REG14 TRF16	Tariff #16 register
TOU REG15	TOU Energy Register #15
TOU REG15 TRF1	Tariff #1 register
TOU REG15 TRF2	Tariff #2 register
...	...
TOU REG15 TRF16	Tariff #16 register
TOU REG16	TOU Energy Register #16
TOU REG16 TRF1	Tariff #1 register
TOU REG16 TRF2	Tariff #2 register
...	...
TOU REG16 TRF16	Tariff #16 register
TOU MAX DMD REG1	TOU Maximum Demand Register #1
DMD1 TRF1 MAX	Tariff #1 register
DMD1 TRF2 MAX	Tariff #2 register
...	...
DMD1 TRF16 MAX	Tariff #16 register
TOU MAX DMD REG2	TOU Maximum Demand Register #2
DMD2 TRF1 MAX	Tariff #1 register
DMD2 TRF2 MAX	Tariff #2 register
...	...
DMD2 TRF16 MAX	Tariff #16 register
TOU MAX DMD REG3	TOU Maximum Demand Register #3
DMD3 TRF1 MAX	Tariff #1 register
DMD3 TRF2 MAX	Tariff #2 register
...	...
DMD3 TRF16 MAX	Tariff #16 register
TOU MAX DMD REG4	TOU Maximum Demand Register #4

Designation	Description
DMD4 TRF1 MAX	Tariff #1 register
DMD4 TRF2 MAX	Tariff #2 register
...	...
DMD4 TRF16 MAX	Tariff #16 register
TOU MAX DMD REG5	TOU Maximum Demand Register #5
DMD5 TRF1 MAX	Tariff #1 register
DMD5 TRF2 MAX	Tariff #2 register
...	...
DMD5 TRF16 MAX	Tariff #16 register
TOU MAX DMD REG6	TOU Maximum Demand Register #6
DMD6 TRF1 MAX	Tariff #1 register
DMD6 TRF2 MAX	Tariff #2 register
...	...
DMD6 TRF16 MAX	Tariff #16 register
TOU MAX DMD REG7	TOU Maximum Demand Register #7
DMD7 TRF1 MAX	Tariff #1 register
DMD7 TRF2 MAX	Tariff #2 register
...	...
DMD7 TRF16 MAX	Tariff #16 register
TOU MAX DMD REG8	TOU Maximum Demand Register #8
DMD8 TRF1 MAX	Tariff #1 register
DMD8 TRF2 MAX	Tariff #2 register
...	...
DMD8 TRF16 MAX	Tariff #16 register
TOU MAX DMD REG9	TOU Maximum Demand Register #9
DMD9 TRF1 MAX	Tariff #1 register
DMD9 TRF2 MAX	Tariff #2 register
...	...
DMD9 TRF16 MAX	Tariff #16 register
TOU MAX DMD REG10	TOU Maximum Demand Register #10
DMD10 TRF1 MAX	Tariff #1 register
DMD10 TRF2 MAX	Tariff #2 register
...	...
DMD10 TRF16 MAX	Tariff #16 register
TOU MAX DMD REG11	TOU Maximum Demand Register #11
DMD11 TRF1 MAX	Tariff #1 register
DMD11 TRF2 MAX	Tariff #2 register
...	...
DMD11 TRF16 MAX	Tariff #16 register
TOU MAX DMD REG12	TOU Maximum Demand Register #12
DMD12 TRF1 MAX	Tariff #1 register
DMD12 TRF2 MAX	Tariff #2 register
...	...
DMD12 TRF16 MAX	Tariff #16 register
TOU MAX DMD REG13	TOU Maximum Demand Register #13
DMD13 TRF1 MAX	Tariff #1 register
DMD13 TRF2 MAX	Tariff #2 register
...	...
DMD13 TRF16 MAX	Tariff #16 register
TOU MAX DMD REG14	TOU Maximum Demand Register #14
DMD14 TRF1 MAX	Tariff #1 register
DMD14 TRF2 MAX	Tariff #2 register
...	...
DMD14 TRF16 MAX	Tariff #16 register
TOU MAX DMD REG15	TOU Maximum Demand Register #15
DMD15 TRF1 MAX	Tariff #1 register
DMD15 TRF2 MAX	Tariff #2 register
...	...
DMD15 TRF16 MAX	Tariff #16 register
TOU MAX DMD REG16	TOU Maximum Demand Register #16
DMD16 TRF1 MAX	Tariff #1 register
DMD16 TRF2 MAX	Tariff #2 register
...	...
DMD16 TRF16 MAX	Tariff #16 register

¹ In 4LN3, 3LN3 and 3BLN3 wiring modes, the voltages are line-to-neutral; for any other wiring mode, they will be line-to-line.

Appendix D EN50160 Statistics Log Files

The following table lists the EN50160 evaluation parameters recorded by the device in the EN50160 statistics data log files. The second column shows data abbreviations used in the PAS data log reports. Data log file sections are highlighted in bold.

EN50160 Compliance Statistics Log (Data Log #9)

Field No.	Designation	Description
Power Frequency		
1	Nnv	Number of non-valid 10-sec intervals
2	N	Number of valid 10-sec intervals
3	N1	Number of incidents $\pm 1\%$, N1
4	N2	Number of incidents $+4\%/-6\%$, N2
5	N1/N, %	EN50160 compliance ratio, N1/N
6	N2/N, %	EN50160 compliance ratio, N2/N
7	Freq Min	Minimum frequency
8	Freq Max	Maximum frequency
Supply Voltage Variations		
1	Nnv	Number of non-valid 10-min intervals
2	N	Number of valid 10-min intervals
3	N1	Number of polyphase incidents $\pm 10\%$, N1
4	N2	Number of polyphase incidents $+10\%/-15\%$, N2
5	N1/N, %	EN50160 compliance ratio, N1/N
6	N2/N, %	EN50160 compliance ratio, N2/N
7	V1 N1	Number of incidents $\pm 10\%$ on phase V1
8	V1 Min	Minimum voltage on phase V1
9	V1 Max	Maximum voltage on phase V1
10	V2 N1	Number of incidents $\pm 10\%$ on phase V2
11	V2 Min	Minimum voltage on phase V2
12	V2 Max	Maximum voltage on phase V2
13	V3 N1	Number of incidents $\pm 10\%$ on phase V3
14	V3 Min	Minimum voltage on phase V3
15	V3 Max	Maximum voltage on phase V3
Rapid Voltage Changes		
1	N1	Number of polyphase incidents
2	V1 N1	Number of incidents on phase V1
3	V1 dV%	Maximum voltage variation on phase V1, dV/Un%
4	V2 N1	Number of incidents on phase V2
5	V2 dV%	Maximum voltage variation on phase V2, dV/Un%
6	V3 N1	Number of incidents on phase V3
7	V3 dV%	Maximum voltage variation on phase V3, dV/Un%
Flicker		
1	Nnv	Number of non-valid 10-min intervals
2	N	Number of valid 10-min intervals
3	N1	Number of polyphase incidents Plt $> 1\%$, N1
4	N1/N, %	EN50160 compliance ratio, N1/N
5	V1 N1	Number of incidents Plt $> 1\%$ on phase V1
6	V1 Plt Max	Maximum Plt on phase V1
7	V2 N1	Number of incidents Plt $> 1\%$ on phase V2
8	V2 Plt Max	Maximum Plt on phase V2
9	V3 N1	Number of incidents Plt $> 1\%$ on phase V3
10	V3 Plt Max	Maximum Plt on phase V3
Voltage Dips (indicative statistics)		
1	N11 90%/100ms	Number of polyphase incidents $u < 90\%/t < 100\text{ms}$
2	N12 85%/100ms	Number of polyphase incidents $u < 85\%/t < 100\text{ms}$
3	N13 70%/100ms	Number of polyphase incidents $u < 70\%/t < 100\text{ms}$
4	N14 40%/100ms	Number of polyphase incidents $u < 40\%/t < 100\text{ms}$
5	N11 90%/500ms	Number of polyphase incidents $u < 90\%/t < 500\text{ms}$
6	N12 85%/500ms	Number of polyphase incidents $u < 85\%/t < 500\text{ms}$
7	N13 70%/500ms	Number of polyphase incidents $u < 70\%/t < 500\text{ms}$
8	N14 40%/500ms	Number of polyphase incidents $u < 40\%/t < 500\text{ms}$
9	N11 90%/1s	Number of polyphase incidents $u < 90\%/t < 1\text{s}$
10	N12 85%/1s	Number of polyphase incidents $u < 85\%/t < 1\text{s}$
11	N13 70%/1s	Number of polyphase incidents $u < 70\%/t < 1\text{s}$
12	N14 40%/1s	Number of polyphase incidents $u < 40\%/t < 1\text{s}$
13	N11 90%/3s	Number of polyphase incidents $u < 90\%/t < 3\text{s}$
14	N12 85%/3s	Number of polyphase incidents $u < 85\%/t < 3\text{s}$

Field No.	Designation	Description
15	N13 70%/3s	Number of polyphase incidents $u < 70\% / t < 3s$
16	N14 40%/3s	Number of polyphase incidents $u < 40\% / t < 3s$
17	N11 90%/20s	Number of polyphase incidents $u < 90\% / t < 20s$
18	N12 85%/20s	Number of polyphase incidents $u < 85\% / t < 20s$
19	N13 70%/20s	Number of polyphase incidents $u < 70\% / t < 20s$
20	N14 40%/20s	Number of polyphase incidents $u < 40\% / t < 20s$
21	N11 90%/60s	Number of polyphase incidents $u < 90\% / t < 60s$
22	N12 85%/60s	Number of polyphase incidents $u < 85\% / t < 60s$
23	N13 70%/60s	Number of polyphase incidents $u < 70\% / t < 60s$
24	N14 40%/60s	Number of polyphase incidents $u < 40\% / t < 60s$
25	N11 90%/180s	Number of polyphase incidents $u < 90\% / t < 180s$
26	N12 85%/180s	Number of polyphase incidents $u < 85\% / t < 180s$
27	N13 70%/180s	Number of polyphase incidents $u < 70\% / t < 180s$
28	N14 40%/180s	Number of polyphase incidents $u < 40\% / t < 180s$
29	V1 N1	Total number of incidents on phase V1
30	V1 Min	Minimum residual voltage on phase V1
31	V2 N1	Total number of incidents on phase V2
32	V2 Min	Minimum residual voltage on phase V2
33	V3 N1	Total number of incidents on phase V3
34	V3 Min	Minimum residual voltage on phase V3
		Voltage Interruptions (indicative statistics)
1	N1 1s	Number of polyphase incidents $t < 1s$
2	N2 180s	Number of polyphase incidents $t < 180s$
3	N3 >180s	Number of polyphase incidents $t > 180s$
4	V1 Min	Minimum residual voltage on phase V1
5	V2 Min	Minimum residual voltage on phase V2
6	V3 Min	Minimum residual voltage on phase V3
		Temporary Overvoltages (indicative statistics)
1	N11 110%/1s	Number of polyphase incidents $u > 110\% / t < 1s$
2	N12 120%/1s	Number of polyphase incidents $u > 120\% / t < 1s$
3	N13 140%/1s	Number of polyphase incidents $u > 140\% / t < 1s$
4	N14 160%/1s	Number of polyphase incidents $u > 160\% / t < 1s$
5	N15 200%/1s	Number of polyphase incidents $u > 200\% / t < 1s$
6	N21 110%/60s	Number of polyphase incidents $u > 110\% / t < 60s$
7	N22 120%/60s	Number of polyphase incidents $u > 120\% / t < 60s$
8	N23 140%/60s	Number of polyphase incidents $u > 140\% / t < 60s$
9	N24 160%/60s	Number of polyphase incidents $u > 160\% / t < 60s$
10	N25 200%/60s	Number of polyphase incidents $u > 200\% / t < 60s$
11	N31 110%/>60s	Number of polyphase incidents $u > 110\% / t > 60s$
12	N32 120%/>60s	Number of polyphase incidents $u > 120\% / t > 60s$
13	N33 140%/>60s	Number of polyphase incidents $u > 140\% / t > 60s$
14	N34 160%/>60s	Number of polyphase incidents $u > 160\% / t > 60s$
15	N35 200%/>60s	Number of polyphase incidents $u > 200\% / t > 60s$
16	V1 N1	Total number of incidents on phase V1
17	V1 Max	Maximum voltage magnitude on phase V1
18	V2 N1	Total number of incidents on phase V2
19	V2 Max	Maximum voltage magnitude on phase V2
20	V3 N1	Total number of incidents on phase V3
21	V3 Max	Maximum voltage magnitude on phase V3
		Transient Overvoltages (indicative statistics)
1	N1 110%	Number of polyphase incidents $u > 120\%$
2	N2 150%	Number of polyphase incidents $u > 150\%$
3	N3 200%	Number of polyphase incidents $u > 200\%$
4	N4 250%	Number of polyphase incidents $u > 250\%$
5	N5 300%	Number of polyphase incidents $u > 300\%$
6	V1 N1 110%	Number of incidents $u > 120\%$ on phase V1
7	V1 N2 150%	Number of incidents $u > 150\%$ on phase V1
8	V1 N3 200%	Number of incidents $u > 200\%$ on phase V1
9	V1 N4 250%	Number of incidents $u > 250\%$ on phase V1
10	V1 N5 300%	Number of incidents $u > 300\%$ on phase V1
11	V2 N1 110%	Number of incidents $u > 120\%$ on phase V2
12	V2 N2 150%	Number of incidents $u > 150\%$ on phase V2
13	V2 N3 200%	Number of incidents $u > 200\%$ on phase V2
14	V2 N4 250%	Number of incidents $u > 250\%$ on phase V2
15	V2 N5 300%	Number of incidents $u > 300\%$ on phase V2
16	V3 N1 110%	Number of incidents $u > 120\%$ on phase V3
17	V3 N2 150%	Number of incidents $u > 150\%$ on phase V3
18	V3 N3 200%	Number of incidents $u > 200\%$ on phase V3

Field No.	Designation	Description
19	V3 N4 250%	Number of incidents u>250% on phase V3
20	V3 N5 300%	Number of incidents u>300% on phase V3
21	V1 Peak Max	Maximum peak voltage on phase V1
22	V2 Peak Max	Maximum peak voltage on phase V2
23	V3 Peak Max	Maximum peak voltage on phase V3
		Supply Voltage Unbalance
1	Nnv	Number of non-valid 10-min intervals
2	N	Number of valid 10-min intervals
3	N1	Number of incidents V Unb > 2%, N1
4	N1/N, %	EN50160 compliance ratio, N1/N
5	V Unb% Max	Maximum voltage unbalance
		Harmonic Voltage
1	Nnv	Number of non-valid 10-min intervals
2	N	Number of valid 10-min intervals
3	N1	Number of polyphase harmonic voltage incidents, N1
4	N2	Number of polyphase voltage THD incidents, N2
5	N1/N, %	EN50160 harmonic voltage compliance ratio, N1/N
6	N2/N, %	EN50160 voltage THD compliance ratio, N2/N
7	V1 N1	Number of harmonic voltage incidents on phase V1
8	V1 N2	Number of voltage THD incidents on phase V1
9	V1 HD% Max	Worst-case harmonic magnitude on phase V1, %Un
10	V1 H#	Worst-case harmonic component number on phase V1
11	V1 THD Max	Worst-case voltage THD on phase V1
12	V2 N1	Number of harmonic voltage incidents on phase V2
13	V2 N2	Number of voltage THD incidents on phase V2
14	V2 HD% Max	Worst-case harmonic magnitude on phase V2, %Un
15	V2 H#	Worst-case harmonic component number on phase V2
16	V2 THD Max	Worst-case voltage THD on phase V2
17	V3 N1	Number of harmonic voltage incidents on phase V3
18	V3 N2	Number of voltage THD incidents on phase V3
19	V3 HD% Max	Worst-case harmonic magnitude on phase V3, %Un
20	V3 H#	Worst-case harmonic component number on phase V3
21	V3 THD Max	Worst-case voltage THD on phase V3
		Interharmonic Voltage
1	Nnv	Number of non-valid 10-min intervals
2	N	Number of valid 10-min intervals
3	N1	Number of polyphase interharmonic voltage incidents, N1
4	N2	Number of polyphase interharmonic THD incidents, N2
5	N1/N, %	EN50160 interharmonic voltage compliance ratio, N1/N
6	N2/N, %	EN50160 interharmonic voltage THD compliance ratio, N2/N
7	V1 N1	Number of interharmonic voltage incidents on phase V1
8	V1 N2	Number of interharmonic voltage THD incidents on phase V1
9	V1 HD% Max	Worst-case interharmonic magnitude on phase V1, %Un
10	V1 H#	Worst-case interharmonic component number on phase V1
11	V1 THD Max	Worst-case interharmonic voltage THD on phase V1
12	V2 N1	Number of interharmonic voltage incidents on phase V2
13	V2 N2	Number of interharmonic voltage THD incidents on phase V2
14	V2 HD% Max	Worst-case interharmonic magnitude on phase V2, %Un
15	V2 H#	Worst-case interharmonic component number on phase V2
16	V2 THD Max	Worst-case interharmonic voltage THD on phase V2
17	V3 N1	Number of interharmonic voltage incidents on phase V3
18	V3 N2	Number of interharmonic voltage THD incidents on phase V3
19	V3 HD% Max	Worst-case interharmonic magnitude on phase V3, %Un
20	V3 H#	Worst-case interharmonic component number on phase V3
21	V3 THD Max	Worst-case interharmonic THD on phase V3
		Mains Signaling Voltage
1	Nnv	Number of non-valid 3-sec intervals
2	N	Number of valid 3-sec intervals
3	N1	Number of polyphase incidents, N1
4	N1/N, %	EN50160 compliance ratio, N1/N
5	V1 N1	Number of incidents on phase V1
6	V1 Frq1 %Un	Maximum 1st signaling voltage magnitude on phase V1, %Un
7	V1 Frq2 %Un	Maximum 2nd signaling voltage magnitude on phase V1, %Un
8	V1 Frq3 %Un	Maximum 3rd signaling voltage magnitude on phase V1, %Un
9	V1 Frq4 %Un	Maximum 4th signaling voltage magnitude on phase V1, %Un
10	V2 N1	Number of incidents on phase V2
11	V2 Frq1 %Un	Maximum 1st signaling voltage magnitude on phase V2, %Un
12	V2 Frq2 %Un	Maximum 2nd signaling voltage magnitude on phase V2, %Un

Field No.	Designation	Description
13	V2 Frq3 %Un	Maximum 3rd signaling voltage magnitude on phase V2, %Un
14	V2 Frq4 %Un	Maximum 4th signaling voltage magnitude on phase V2, %Un
15	V3 N1	Number of incidents on phase V3
16	V3 Frq1 %Un	Maximum 1st signaling voltage magnitude on phase V3, %Un
17	V3 Frq2 %Un	Maximum 2nd signaling voltage magnitude on phase V3, %Un
18	V3 Frq3 %Un	Maximum 3rd signaling voltage magnitude on phase V3, %Un
19	V3 Frq4 %Un	Maximum 4th signaling voltage magnitude on phase V3, %Un
20	Frq1	1st signaling voltage frequency
21	Frq2	2nd signaling voltage frequency
22	Frq3	3rd signaling voltage frequency
23	Frq4	4th signaling voltage frequency

EN50160 Harmonics Survey Log (Data Log #10)

Field No.	Designation	Description
		V1 Harmonic Voltage
		Maximum THD
1	THD MAX	Maximum THD
2	THDO MAX	Maximum odd harmonics THD
3	THDE MAX	Maximum even harmonics THD
4	%HD02 MAX	Maximum H02 harmonic voltage magnitude, %Un
5	%HD03 MAX	Maximum H03 harmonic voltage magnitude, %Un
...	...	
52	%HD50 MAX	Maximum H50 harmonic voltage magnitude, %Un
		V2 Harmonic Voltage
		Maximum THD
1	THD MAX	Maximum THD
2	THDO MAX	Maximum odd harmonics THD
3	THDE MAX	Maximum even harmonics THD
4	%HD02 MAX	Maximum H02 harmonic voltage magnitude, %Un
5	%HD03 MAX	Maximum H03 harmonic voltage magnitude, %Un
...	...	
52	%HD50 MAX	Maximum H50 harmonic voltage magnitude, %Un
		V3 Harmonic Voltage
		Maximum THD
1	THD MAX	Maximum THD
2	THDO MAX	Maximum odd harmonics THD
3	THDE MAX	Maximum even harmonics THD
4	%HD02 MAX	Maximum H02 harmonic voltage magnitude, %Un
5	%HD03 MAX	Maximum H03 harmonic voltage magnitude, %Un
...	...	
52	%HD50 MAX	Maximum H50 harmonic voltage magnitude, %Un

Appendix E Data Scales

The maximum values for volts, amps and power in the PM180 setup and in communications are limited by the voltage and current scale settings. See [Advanced Device Setup](#) in Chapter 6 on how to change the voltage and current scales in your device.

The following table shows the device data scales.

Scale	Conditions	Range
Maximum voltage (V max)	All configurations	Voltage scale \times PT Ratio, V ¹
Maximum current (I max)	All configurations	Current scale \times CT Ratio, A ^{2, 3}
Maximum fault current (I _x max)	All configurations	30 \times CT primary current, A
Maximum Power (P max) ⁴	All configurations	V max \times I max \times 2, W
Maximum frequency	50 or 60 Hz	100 Hz

¹ The default voltage scale is 828V. The recommended voltage scale is 120V+20% = 144V for using with external PT's, and 690V+20% = 828V for a direct connection to power line.

² CT Ratio = CT primary current/CT secondary current

³ The default current scale is 2 \times CT secondary for the IEC current input option (2.0A with 1A secondaries and 10.0A with 5A secondaries), and 4 \times CT secondary for the ANSI current input option (4.0A with 1A secondaries and 20.0A with 5A secondaries).

⁴ Maximum power is rounded to whole kilowatts. With PT=1.0, it is limited to 9,999,000 W.

Appendix F Device Diagnostic Codes

Diagnostic Code	Description	Reason
0	Critical error	Unrecoverable system failure - device operation stops
1	Permanent fault (critical error)	Repeated unrecoverable failure
2	Memory/Data error	Hardware failure
3	Hardware watchdog reset	Hardware failure
4	DSP/Sampling fault	Hardware failure
5	CPU exception	Hardware failure
7	Software watchdog timeout	Hardware failure
8	Power down/Up	Loss of power
9	Warm restart/Device reset	External restart via communications or by firmware upgrade
10	Configuration reset	Corrupted setup data has been replaced with the default configuration
11	RTC fault (critical error)	The clock time has been lost
12	Configuration fault (critical error)	Factory, calibration or basic device configuration data has been corrupted
14	Expanded memory fault	Hardware failure
15	CPU EEPROM fault	Hardware failure
16	AC board EEPROM fault	Hardware failure
17	I/O board EEPROM fault	Hardware failure
20	C Library error	Hardware failure
21	RTOS Kernel error	Hardware failure
22	Task error	Hardware failure
24	IRIG-B signal lost	No IRIG-B signal from the GPS master clock. Cleared automatically when the IRIG-B signal is detected.
25	IRIG-B time unlocked	The GPS master clock has lost the satellite signal. Cleared automatically when the satellite signal is locked.

NOTE

A critical error is an unrecoverable hardware or configuration failure that causes the device to release all its outputs and to stop normal operation until the critical error is cleared.

See [Device Diagnostics](#) for more information on the PM180 built-in diagnostics. See [Viewing and Clearing Device Diagnostics](#) in Chapter 10, [Viewing and Clearing Device Diagnostics](#) in Chapter 3, and [Status Information Display](#) in Chapter 3 on how to inspect and clear the device diagnostics.