



Branch Feeder Monitor BFM II EM and DFR

OPERATION and INSTALLATION MANUAL



REVISION HISTORY

A1	Nov 2015	Initial guide
A2	Jan 2016	Updated guide
A3	Mar 2016	Electrical Installation load numbering
A4	Jun 2016	Sealing the BFM II
A5	Oct 2016	UL comments and Marking Label update
A6	Dec 2016	9RO module, update HMI user guide
A7	Jan 2017	Added 4AI module Added wiring connections: 4LL3 (delta) and 3OP2/3OP3 (open delta) Number of records for each log type is updated UL comments
A8	Aug 2017	Added grounding instructions Updated Figure 2.11
A9	Aug 2019	Add module dimensions Updated Figure 1-1 Device Label Typing error - Chapter 6 changed to Chapter 4 Monitoring Meter Batteries in Chapter 2 was updated
A10	July 2020	Digital Fault Recorder and Harmonics

LIMITED WARRANTY

The manufacturer offers the customer a 24-month functional warranty on the instrument for faulty workmanship or parts from date of dispatch from the distributor. In all cases, this warranty is valid for 36 months from the date of production. This warranty is on a return to factory basis.

This warranty is only applicable to SATEC instruments using HACS SATEC current transformers.

The manufacturer does not accept liability for any damage caused by instrument malfunction. The manufacturer accepts no responsibility for the suitability of the instrument to the application for which it was purchased.

Failure to install, set up or operate the instrument according to the instructions herein will void the warranty.

Only a duly authorized representative of the manufacturer may open your instrument. The unit should only be opened in a fully anti-static environment. Failure to do so may damage the electronic components and will void the warranty.

The greatest care has been taken to manufacture and calibrate your instrument. However, these instructions do not cover all possible contingencies that may arise during installation, operation or maintenance, and all details and variations of this equipment are not covered by these instructions.

For additional information regarding installation, operation or maintenance of this instrument, contact the manufacturer or your local representative or distributor.

All trademarks are property of their respective owners.

August 2020

Copyright 2011-2020 © SATEC Ltd.

WARNING

Read the instructions in this manual before performing installation and take note of the following precautions:

- BFM II is intended for measurements performed in building and industrial installations, relating to measurement category III (UL61010-1 3rd ed.), pollution degree 2.
- Always open or disconnect circuit from power-distribution system (or service) of building before installing or servicing current transformers (HACS).
- The current transformers may not be installed in equipment where they exceed 75 percent of the wiring space of any cross-sectional area within the equipment.
- Restrict installation of current transformer in an area where it would block ventilation openings.
- Restrict installation of current transformer in an area of breaker arc venting.
- Secure current transformer and route conductors so that they do not directly contact live terminals or bus.
- Ensure that all incoming AC power and other power sources are turned OFF before performing any work on the instrument. Failure to do so may result in serious or even fatal injury and/or equipment damage.
- Before connecting the instrument to the power source, check the labels at the front of the instrument to ensure that your instrument is equipped with the appropriate rating input voltages and currents.
- Under no circumstances should the instrument be connected to a power source if it is damaged.
- Any use or operations not specified by this manual may cause a protection impairment to the device.
- To prevent potential fire or shock hazard, do not expose the instrument to rain or moisture.
- While installing HACS to the secondary of an external third party current transformer, the external current transformer secondary output must never be allowed to be open circuit when the primary is energized. An open circuit can cause high voltages, possibly resulting in equipment damage, fire and even **serious or fatal injury**. Ensure that the current transformer wiring is secured using an external strain relief to reduce mechanical strain on the screw terminals, if necessary.
- Only qualified personnel familiar with the instrument and its associated electrical equipment must perform setup procedures.
- Do not open the instrument under any circumstances when it is connected to a power source.
- Do not use the instrument for primary protection functions where failure of the device can cause fire, injury or death. The instrument can only be used for secondary protection if needed.

Read this manual thoroughly before connecting the device to the current carrying circuits. During operation of the device, hazardous voltages are present on input terminals. Failure to observe precautions can result in serious or even fatal injury or damage to equipment.

Table of Contents

Chapter 1 General Information	12
Firmware Versions.....	13
Labeling	13
Chapter 2 Installation.....	15
Mechanical Installation	15
Dimensions	16
Electrical Installation.....	20
Connecting the wires.....	21
Typical Installation	22
Installation with Auxiliary Power Supply	26
Sealing the BFM II	29
Communications	31
Serial Communication ports.....	31
Network Communication ports	32
USB Connection (standard)	33
Input/Output.....	34
Digital Inputs.....	34
Relay Outputs.....	34
Analog Inputs	36
Installing the Battery backup.....	37
Controls and Indicators.....	38
Indicator LEDs	38
Energy Pulse LED.....	38
Front Panel Display	38
Communicating with the BFM II.....	39
COM1 and COM3 (standard), COM2 (optional) Serial Communications .	39
COM4 Port (optional).....	39
USB Port (standard)	39
Ethernet Port (standard).....	40
Wireless Ethernet Port – WiFi (optional)	40
CELLULAR Port (optional)	40
Using the GDM (optional).....	40
Using PAS	40
Device Settings.....	41
Meter Security	41
Submeter System.....	42
Submeter Addressing	42
Basic Device Settings.....	42
Energy/TOU System	43
Tariff Rates	43
Fault Recording.....	43
Harmonic Measurements	43
Billing Data Recording and Load Profiling	44
Device Diagnostics	44
Monitoring Meter Batteries.....	44
Billing Data Display	45

Chapter 3	BFM II Graphical Display Operations	46
	Startup Diagnostics	46
	Display Features	47
	Submeter Displays	47
	Display Update	47
	Auto Return	47
	Auto Scroll	47
	Backlight	47
	Navigation Buttons	48
	Measurements Views	48
	Device Control views	52
	Instrument Info views	52
	Waveforms views	53
	Phasor views	53
	Logs views	53
	Instrument Setup	54
	Entering a Password	54
	Viewing and Changing Instrument Setup parameters	54
	General Setup	55
	Submeter Channel Assignments	57
	Transformer Correction	57
	Local Setting	57
	Time Adjustment Setting	58
	Communication Setup	58
	Reset Setup	61
	Display Info and Setup	63
	Display Info	63
	Display Setup	64
	Customer Name	65
Chapter 4	Using PAS™ Application Software	66
	Software Installation	66
	Installing PAS™ Software	66
	Installing the USB driver	66
	Using PAS	68
	Creating a new site for your Meter / Submeters	68
	Setting up Communications	70
	Communicating through a Serial Port	70
	Communicating through the Internet	72
	Communicating through a CELLULAR (2G/3G) module	72
	Communicating through a USB	73
	Preparing Setups	74
	Downloading Setups	74
	Uploading Setups	75
	Authorization	75
	Changing Port Settings	75
	Communication Ports Setup	75
	Setting Up the Local Network	76
	Setting Up Cellular - Public Network	76
	Setting up SNTP Client	77
	Configuring expertpower Client	77
	General Meter Setup	79
	Basic Meter Setup	79
	Channel Assignments	81
	Transformer Correction	82
	Local Settings	83
	Using Digital Inputs	84
	Using Analog Inputs	85

Using Alarm/Control Setpoints	86
Using Counters	88
Configuring the Fault Recorder	89
Display Setup	90
Configuring Billing Energy and TOU Registers	93
Setting up Total and Tariff Registers	93
Configuring the Daily Tariff Schedule	94
Configuring the Season Tariff Schedule	95
Configuring Data Recorders	95
Remote Device Control.....	97
DFR Data Recorders	97
Viewing and Clearing Device Diagnostics	99
Updating the Clock.....	100
Clearing Maximum Demands and Log Files	100
Administration	101
Upgrading Device Firmware	102
Data Monitoring	103
Viewing Real-Time Data.....	103
Retrieving Log Files	104
Appendix A Technical Specifications	106
Environmental Conditions.....	106
Construction.....	106
Overall Dimensions	106
Materials	106
Power Supply.....	106
Main Power Supply (self-energized PS)	106
Auxiliary Power Supply (module)	106
Input Ratings.....	106
AC Voltage Inputs: V1, V2, V3, VN.....	106
AC Current Inputs:	107
Plug-In I/O Ratings	107
Digital Inputs – 4DI/4DO (future) or 9DI or 18DI (up to 4 modules) ..	107
Relay Outputs – 9RO (up to 2 Modules)	107
Relay Outputs – 4DI/4DO (up to 4 Modules - future).....	107
Analog Inputs – 4 Inputs (up to 4 Modules).....	108
Communication Ports	108
COM1 – standard (MCM).....	108
COM2 – optional (Communication Module)	108
COM3 – standard (MCM Display Communication port)	108
USB Port – standard (MCM)	108
Ethernet Port – standard (MCM)	108
COM4 - CELLULAR – optional (Communication Module)	108
Real-time Clock.....	108
Log Memory	109
Graphical Display Module - optional.....	109
GDM	109
Standards Specifications	110
EMC per IEC 62052-11, IEC 62053-22, ANSI C12.1 and ANSI C12.20	110
Safety	110
Insulation	110
Environment Conditions	110
Accuracy	110
Measurement Specifications	111

Appendix B	HACS Connection Template	112
	Upgrading BFM136 to BFM II (236)	114
Appendix C	Parameters for Data Monitoring and Logging	115
Appendix D	Setpoints Triggers and Actions	120
	Setpoint Triggers	120
	Setpoint Actions.....	120
Appendix E	Data Scales	121
Appendix F	Device Diagnostic Codes	122

This package contains

BFM II instrument



BFM II optional modules



BFM II extended instrument



Current Transformers

For Use with listed energy-monitoring current transformers (HACS)

High Accuracy Current Sensors - HACS¹ or Remote Sensor 5A - RS5², according to your request, for more options refer to SATEC HACS Datasheet catalog



HACS - 100A - (solid core): CS1 (EL0072)
Internal Hole \varnothing 12 mm (0.47")



HACS - 100A - (solid core):CS1L (EL0115)
Internal Hole \varnothing 23 mm (0.91")



HACS - 200A - (solid core):CS1L (EL0142)
Internal Hole \varnothing 23 mm (0.91")



HACS - 400A - (solid core) Internal Hole \varnothing 26 mm (1.02")



HACS - 800A - (solid core) Internal Hole
100x32/62mm (4x1.28/2.44")



HACS - 100A - (split core) Internal Hole \varnothing 16 mm (0.63")



HACS - 200A - (split core) Internal Hole \varnothing
24.5x23.1mm (0.96x0.9")



HACS - 400A - (split core) Internal Hole
43x33 mm (1.69x1.13")



HACS - 800A - (split core) Internal Hole
80x50 mm (3.1x1.9")

¹ HACS - SATEC proprietary current sensor for direct connection applications (Low Voltage)

² RS5 - SATEC proprietary current sensor for transformer operated applications (Medium-High Voltage)

Designator Label Sets

HACS designator label set - to attach to the HACS

I1	I10	I19	I28
I2	I11	I20	I29
I3	I12	I21	I30
I4	I13	I22	I31
I5	I14	I23	I32
I6	I15	I24	I33
I7	I16	I25	I34
I8	I17	I26	I35
I9	I18	I27	I36

Cable designator tie-marker

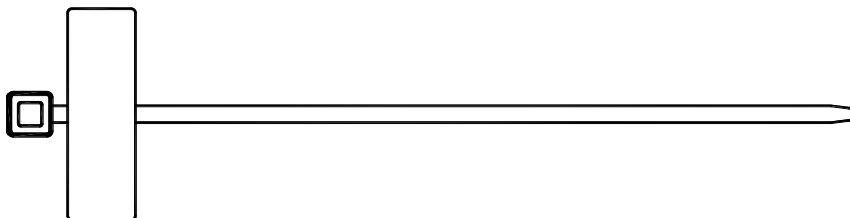

Chapter 1 General Information

The BFM II is a 3-phase, multi-channel, modular multi-function energy meter suitable for use in single-phase and multi-phase electrical networks.

Meter highlights

- Multi-channel submetering - up to 54 single-phase or 27 two-phase or 18 three-phase submeters in a single device. Any combination of single-, two-, and three-phase consumers can be chosen up to a total of 54 current inputs.
- The BFM II product line combines different sizes models:
 - BFM II 18 - Main Control Module (MCM) with 18 current measurement channels - BFM-218
 - BFM II 24 - MCM with 24 current measurement channels (Main + 1 x CIM6) - BFM-224
 - BFM II 30 - MCM with 30 current measurement channels (Main + 2 x CIM6) - BFM-230
 - BFM II 36 - MCM with 36 current measurement channels (Main + 1 x CIM18) - BFM-236
 - BFM II 42 - MCM with 42 current measurement channels (Main + 1 x CIM18 + 1 x CIM6) - BFM-242
 - BFM II 54 - MCM with 54 current measurement channels (Main + 2 x CIM18) - BFM-254
- The BFM II DFR product line combines different sizes models:
 - BFM II 18 - Main Control Module (MCM) with 12 current measurement channels - BFM-218
- The Current Measurement channels module (MCM, CIM18 and CIM6) is combined of two different modules model:
 - Model HACS, high accuracy current sensor (Solid core CT or Split core CT) which is able to connect a variety of different HACS current rating: 100A-3000A/40mA
 - Model RS5, remote sensor 20A/5mA (Split core CT 5A nominal) to be connected as second external CT in Medium/High Voltage applications
- Up to 4 optional plug-in module for I/O and communication ports expansion capabilities.

Features

- Calibrated to meet Class 0.2S active energy and Class 0.5 reactive energy meter accuracy
- 3-phase/2-phase/single-phase meters (true RMS, volts, amps, power, power factor, neutral current)
- Ampere/Volt demand meter
- Time-of-Use, 8 energy/demand registers x 8 tariffs, 4 seasons x 4 types of days, 8 tariff changes per day, easy programmable tariff schedule
- Import/export energy and power demands
- Automatic 500-day daily profile for import/export energy and maximum demand readings (total and tariff registers) separate for each submeter
- Event recorder for logging internal diagnostic events and setpoints operations
- Data recorders; programmable periodical data logs separate for each submeter
- BFMII DFR: Digital Fault Recorder; detect and record fault events and waveform signals per triggers programmed by user
- Harmonics 25th order

- Embedded programmable controller (4 control setpoints, programmable thresholds and delays) separate for each submeter
- Easy to use color graphical LCD display with backlight and Touch Panel (optional)
- 50/60 Hz operation as standard and DC with optional Auxiliary power supply
- Internal clock, keeping the clock running with up to two years backup without external power
- Extended Security: 3-level password security for protecting meter setups and accumulated data from unauthorized changes
- HACS/RS5 with overvoltage protection diodes to avoid any damage while disconnecting the primary current sensor
- Standard RS-485 serial port, 10/100Base T Ethernet port and USB port
- Optional available communication ports:
 - Second serial communication port RS-422/485 (COM2)
 - Cellular communication port 2G/3G
- Modbus RTU and DNP3 communication protocols
- Easy field upgrading device firmware through any communication port

Firmware Versions

Use the following firmware references to check your device's options:

- V37.1.XX – Energy Meter, up to 54 1Ph and 18 3Ph sub-meters
- V37.2.XX – Energy Meter and Digital Fault Recorder, up to 12 3Ph sub-meters

Labeling



Figure 1-1 Device label

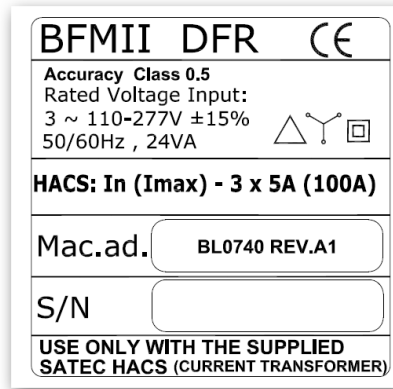
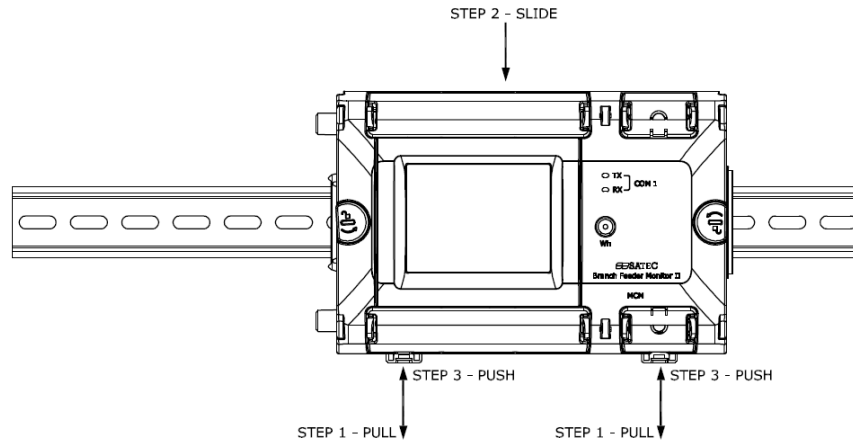

Figure 1-2 DFR Device label

Chapter 2 Installation

Mechanical Installation

Follow instructions below to assemble the BFM II modules:



- STEP 1 - PULL THE 2 DIN RAIL LATCHES USING FLAT SCREWDRIVER.
- STEP 2 - SLIDE THE BFM UNTIL IT IS SEATED ON THE DIN RAIL.
- STEP 3 - SUPPORT THE BFM AND PUSH BOTH DIN RAIL LATCHES.

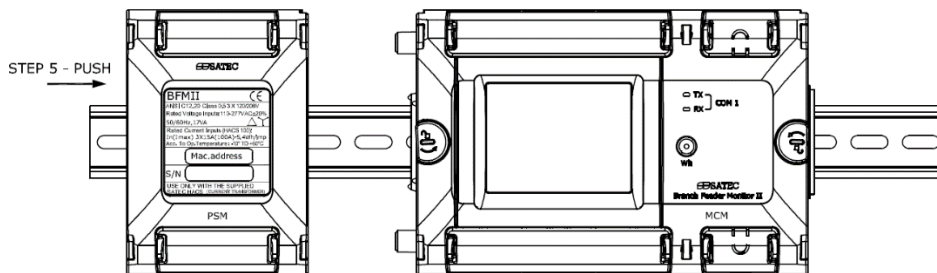

- STEP 4 - REPEAT STEPS 1-3 ON THE PSM.
- STEP 5 - PUSH THE PSM TOWARDS THE BFM.

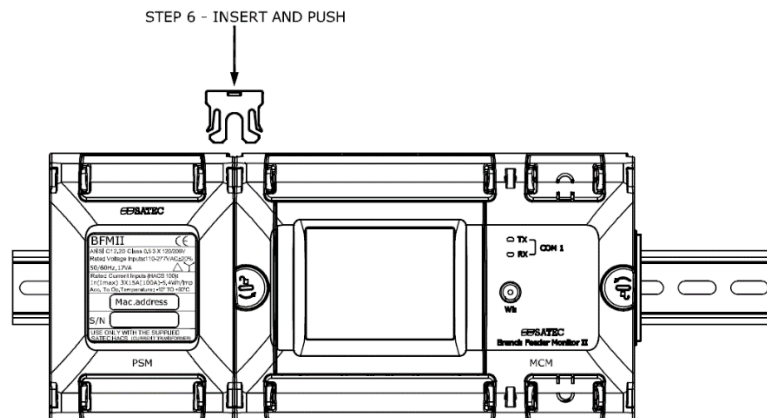

- STEP 6 - INSERT THE SEPERATION PREVENTER LATCH AND PUSH TO SNAP.
- STEP 7 - REMOVE CLEAR COVERS AND WIRE THE INSTRUMENT .

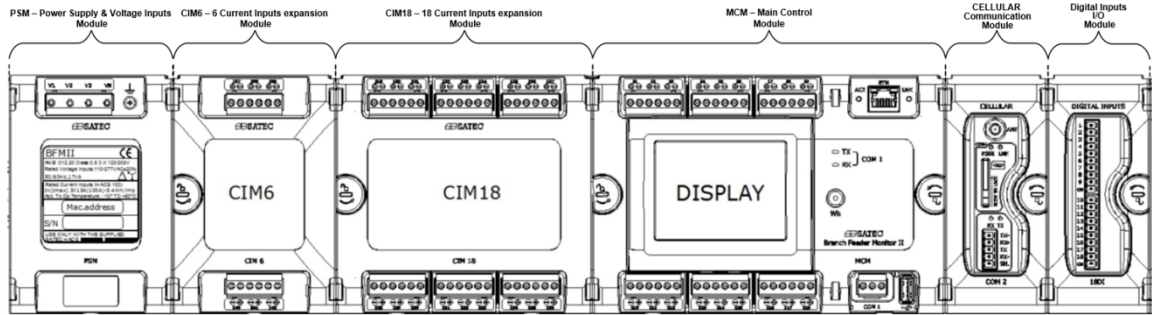

- PSM, CIM6 and CIM18 modules assembled at the MCM left side only
- Communication, I/O and Aux Power supply modules assembled at the MCM right side only

Dimensions

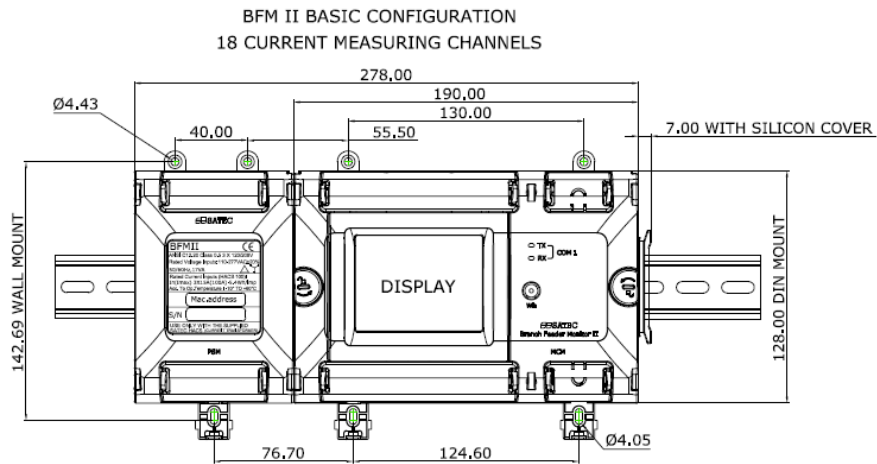

Figure 2-1a BFM II Front View dimensions, DIN Rail and Wall mount - 18 channels

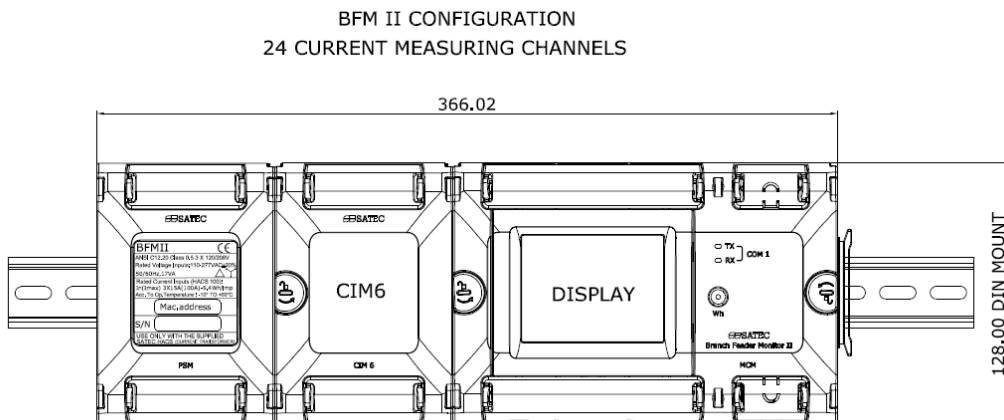

Figure 2-1b BFM II Front View dimensions - 24 channels

BFM II CONFIGURATION
30 CURRENT MEASURING CHANNELS

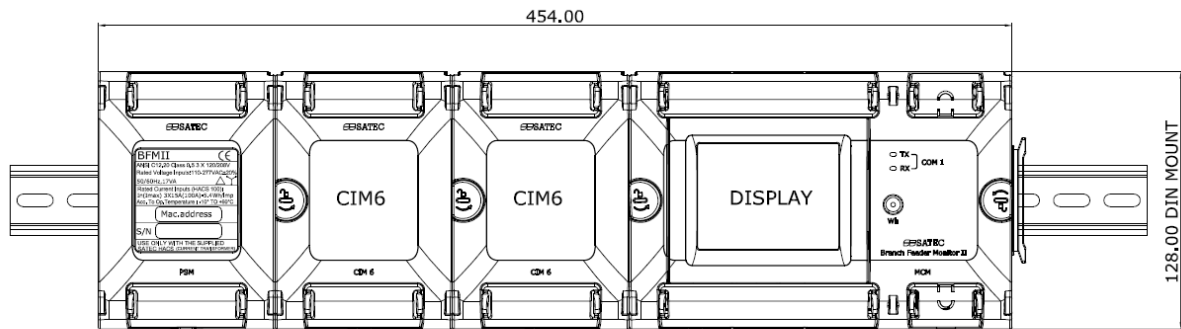

Figure 2-1c BFM II Front View dimensions - 30 channels

BFM II CONFIGURATION
36 CURRENT MEASURING CHANNELS

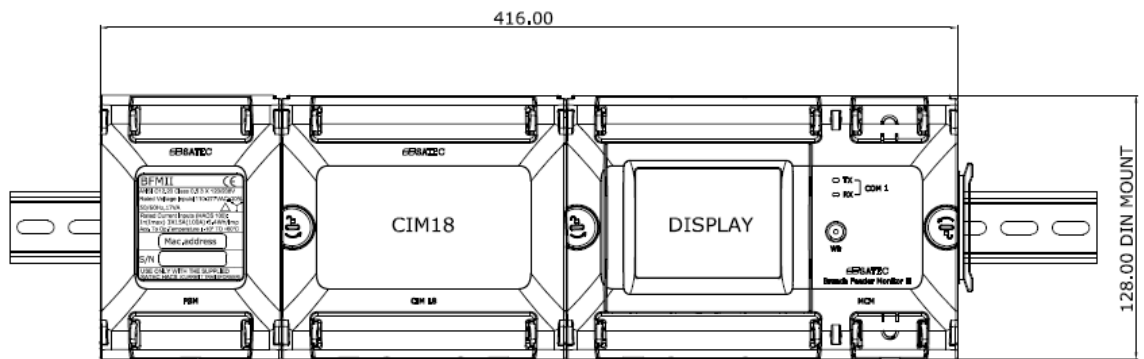

Figure 2-1d BFM II Front View dimensions - 36 channels

BFM II CONFIGURATION
42 CURRENT MEASURING CHANNELS

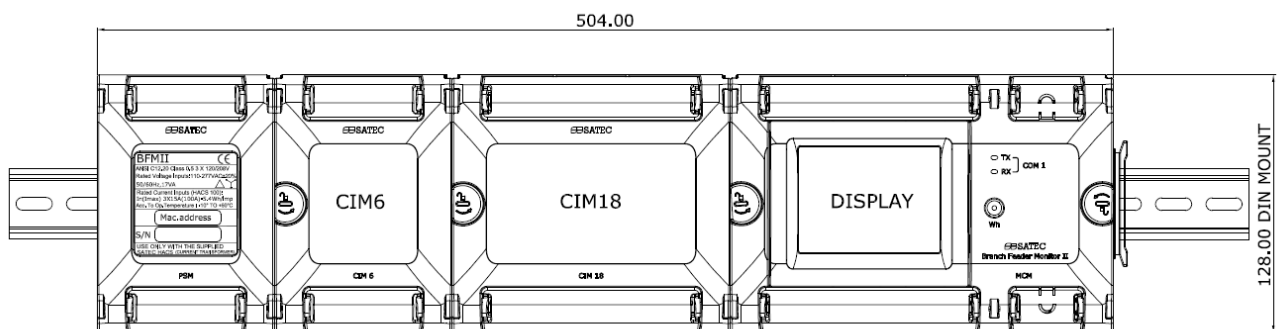

Figure 2-1e BFM II Front View dimensions - 42 channels

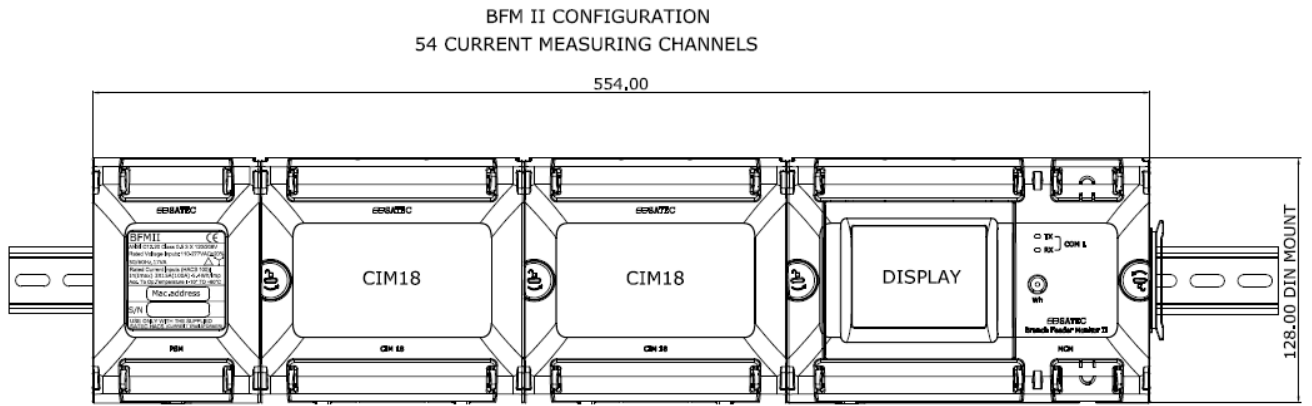

Figure 2-1f BFM II Front View dimensions - 54 channels

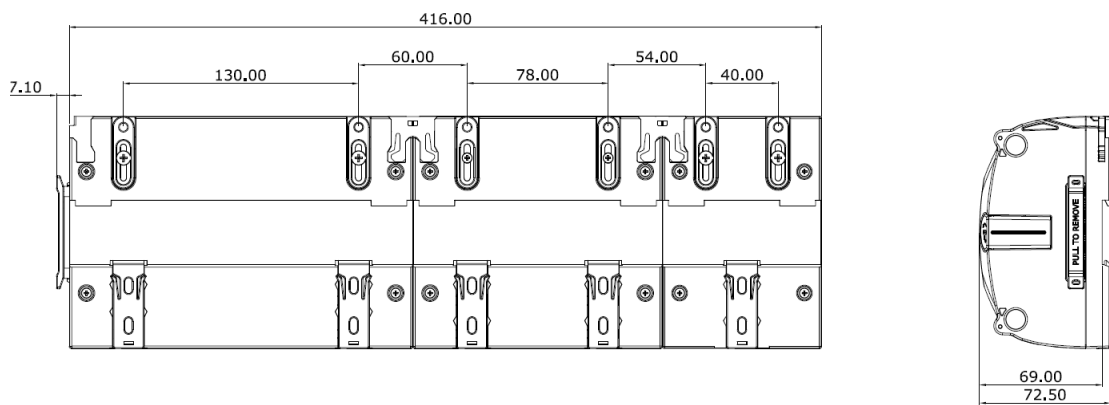

Figure 2-1g BFM II Rear and Side Views dimensions - 36 channels

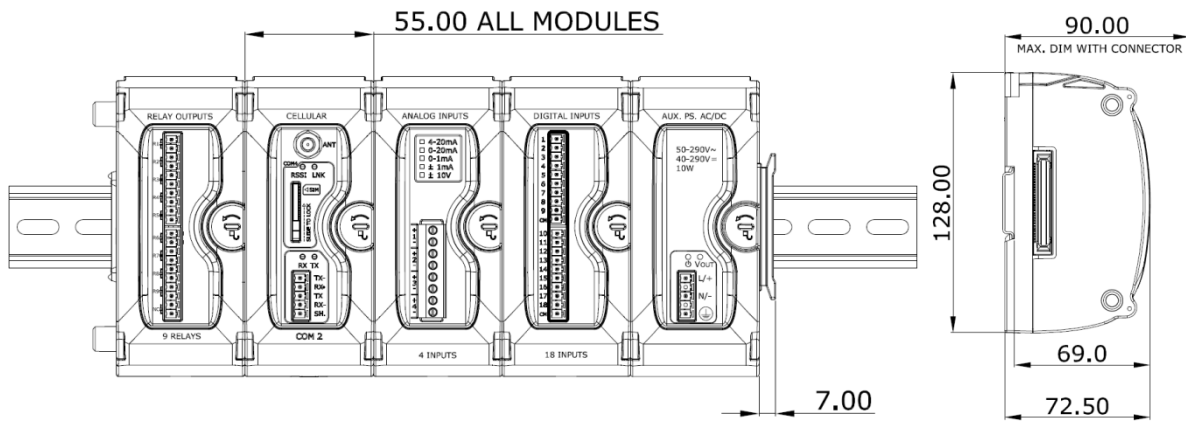

Figure 2-1h BFM II Optional Modules dimensions

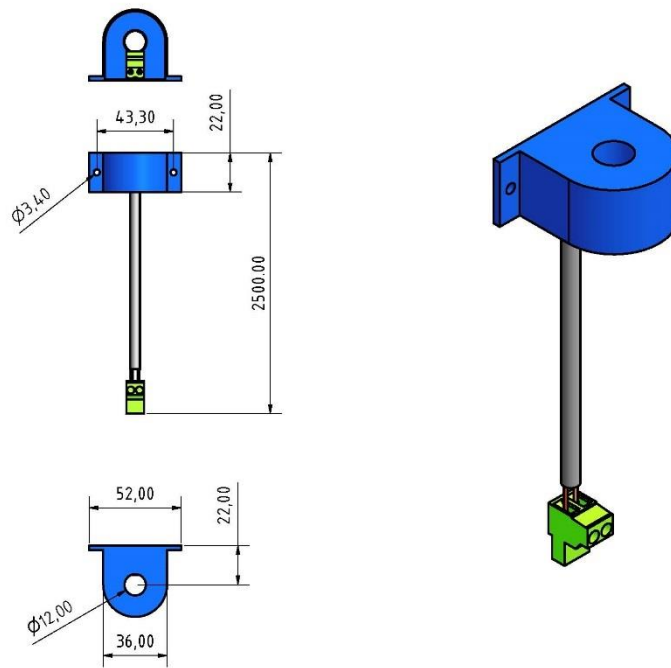

Figure 2-2 Single HACS (100A) dimensions

Electrical Installation

BFM II offers maximum flexibility of current connections by using the variety of HACS options and by wiring any HACS to any current input of the device. The following drawings present applications serviced by the BFM II.

Note:

1. The BFM II is mounted on metal DIN rail which is part of metal plate located inside the switchgear, the metal plate must be connected to earth (ground) for safety purposes with the "main earthing terminal" (screw).
2. All incoming AC power and other power sources are turned OFF before performing any work on the instrument. Failure to do so may result in serious or even fatal injury and/or equipment damage.
3. Before connecting the instrument to the power source, check the labels at the front of the instrument to ensure that your instrument is equipped with the appropriate rating input voltages and currents.
4. Under no circumstances should the instrument be connected to a power source if it is damaged.
5. To prevent potential fire or shock hazard, do not expose the instrument to rain or moisture.
6. While installing HACS to the secondary of an external third party current transformer, the external current transformer secondary output must never be allowed to be open circuit when the primary is energized. An open circuit can cause high voltages, possibly resulting in equipment damage, fire and even serious or fatal injury. Ensure that the current transformer wiring is secured using an external strain relief to reduce mechanical strain on the screw terminals, if necessary.
7. Only qualified personnel familiar with the instrument and its associated electrical equipment must perform setup procedures.
8. It is required to use a 2A Low-Voltage Circuit Breaker before connecting to Mains (voltage inputs)
9. It is recommended to use non-insulated ferrules as wire terminal, such as: P/N: F77-8-M - Manufacturer: PANDUIT
10. There shall be reliable segregation or separation by barriers between the following different circuits:
 - a) Class 1 field and factory installed wiring (such as CT output leads, voltage measurement leads, mains input power), terminals, and uninsulated live parts; and
 - b) Class 2 and Class 3 field installed and factory wiring, terminals, and uninsulated live parts.

Connecting the wires

All conductors must be stranded copper. All conductors and insulation systems and crimped devices must be appropriate for the application. SATEC recommends crimped ferrules on stranded wire. Tighten the screws on the high voltage terminal block to 0.5 Newton-meter (5 inch-pounds) of torque.

The table below summarizes the different conductors' sizes to be used in the BFM II external connections.

Terminals	Conductor size		Torque [Nm]	Notes
	Minimum	maximum		
Voltages Inputs V1, V2, V3, Vn	20AWG (0,52 mm ²)	14 AWG (2.08mm ²)	0.4	Use 600V insulated conductors Recommended ferrule: Panduit F77-8-M
Current Inputs I1-I54	20AWG (0,52 mm ²)	14 AWG (2.08mm ²)	0.4	Use 600V insulated conductors Recommended ferrule: Panduit F77-8-M
Signal Ground stud	20 AWG (0.52 mm ²)	18AWG (1 mm ²)	0.6	Use 600V insulated conductors Recommended Ring Terminal, Vinyl Insulated external conn: Panduit PV18-6R-C
COM1	20AWG (0,52 mm ²)	14 AWG (2.08mm ²)	0.4	Use 600V insulated conductors Recommended ferrule: Panduit F77-8-M
I/O connections	20AWG (0,52 mm ²)	16 AWG (1.3mm ²)	0.2	Use 600V insulated conductors Recommended ferrule: Panduit F77-8-M

Typical Installation

4LN3 wiring connection

4-wire 3-element Wye connection using 3 CTs with Neutral phase.

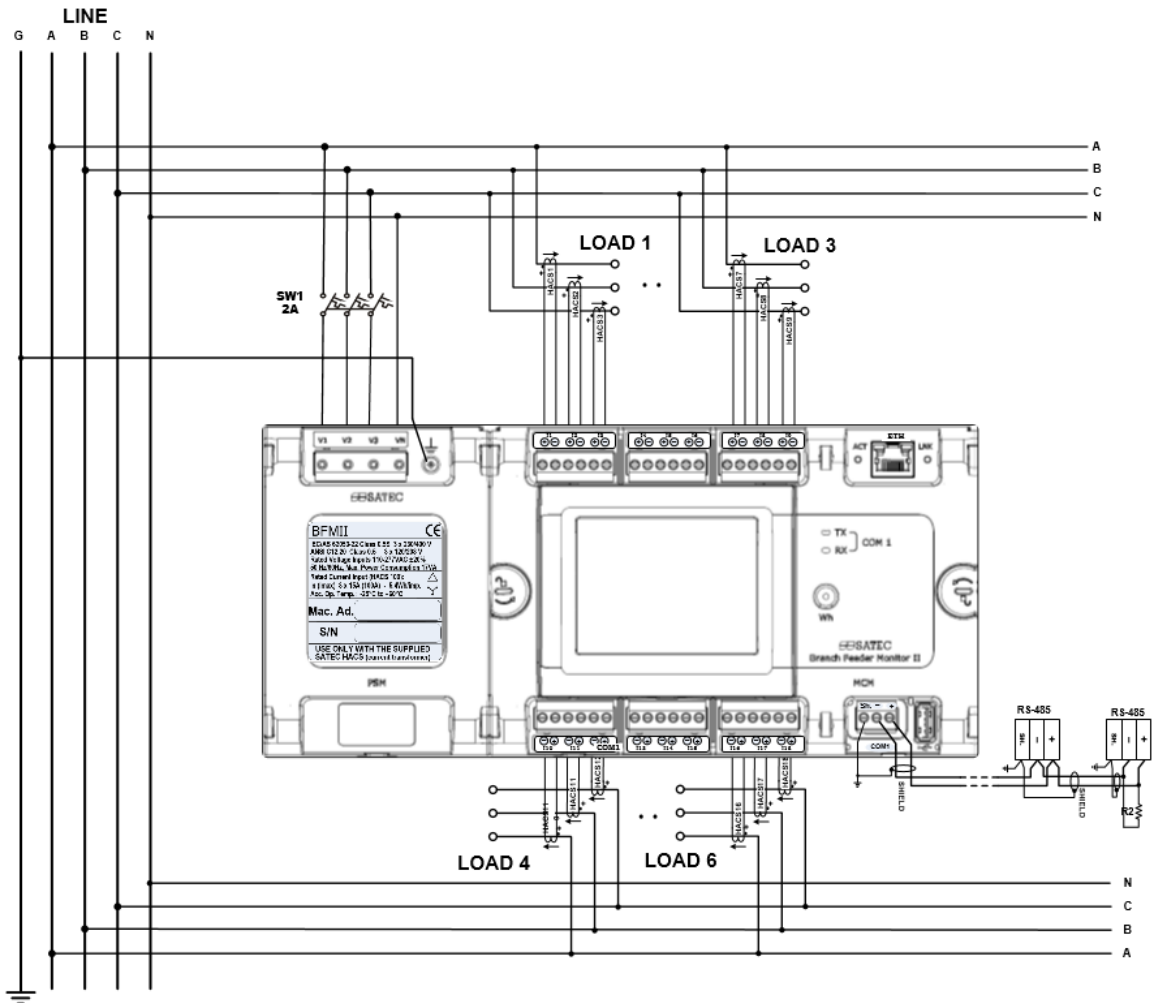

Figure 2-3a Typical Electrical Installation - 6 x 3 phase current input channels wiring - 4LN3

4LL3 wiring connection

4-wire 3-element Delta direct connection using 3 CTs

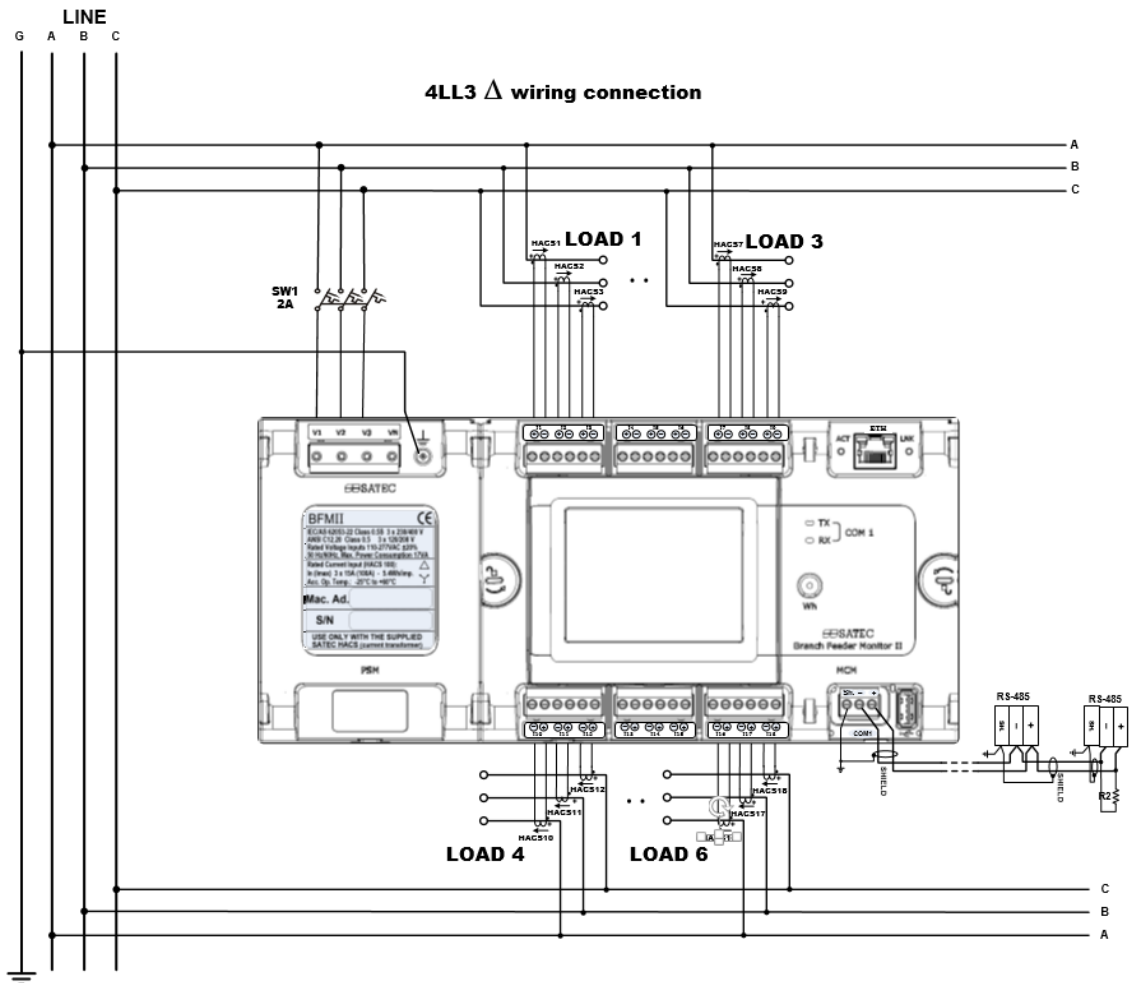

Figure 2-3b Typical Electrical Installation - 6 x 3 phase current input channels wiring - 4LL3

3OP2 wiring connection

3-wire 2-element Open Delta connection using 2PTs and 2CTs.

The maximum input voltage from the PT secondary shall not exceed 250V

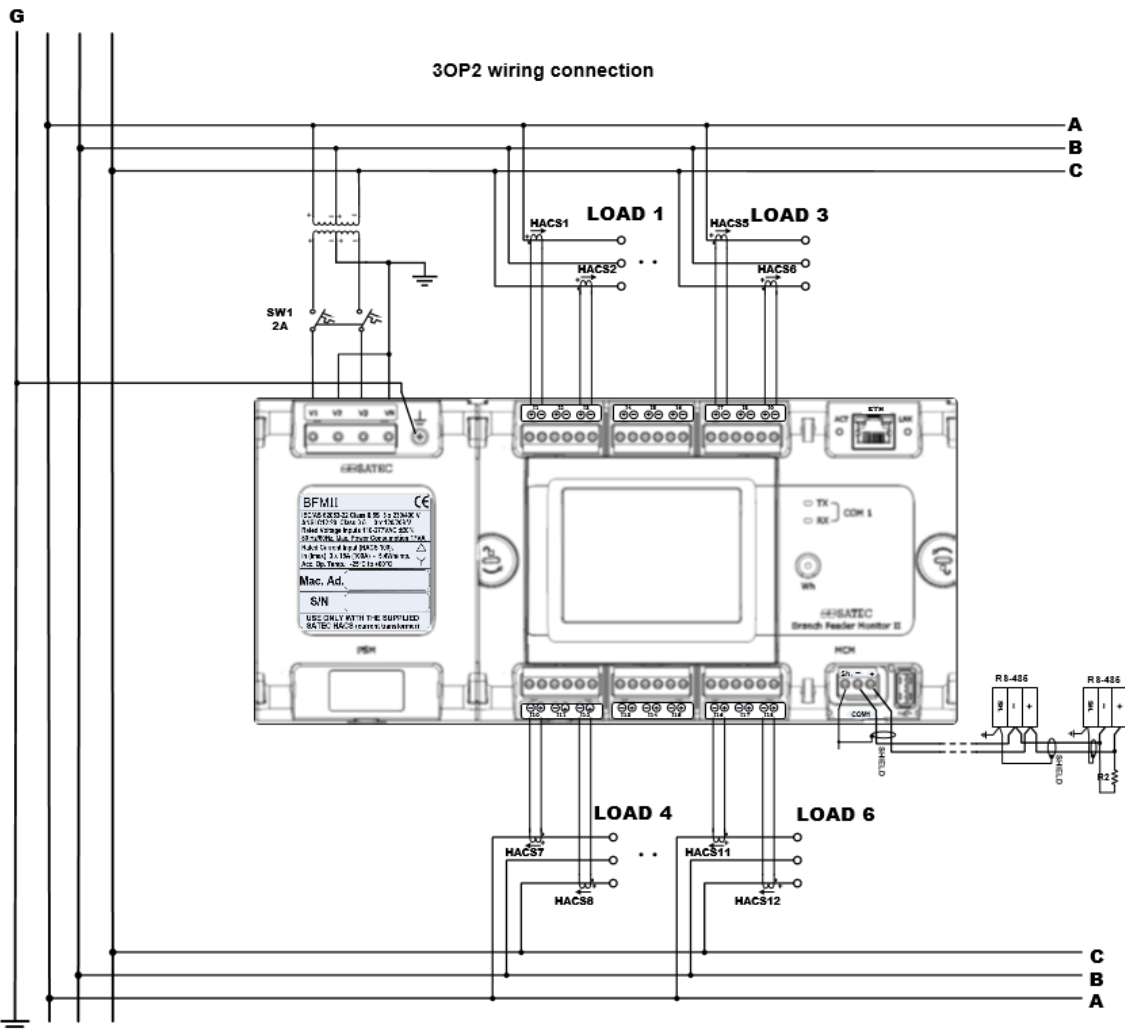

Figure 2-3c Typical Electrical Installation - 6 x 3 phase current input channels wiring - 3OP2

3OP3 wiring connection

3-wire 3-element Open Delta connection using 2PTs and 3CTs

The maximum input voltage from the PT secondary shall not exceed 250V

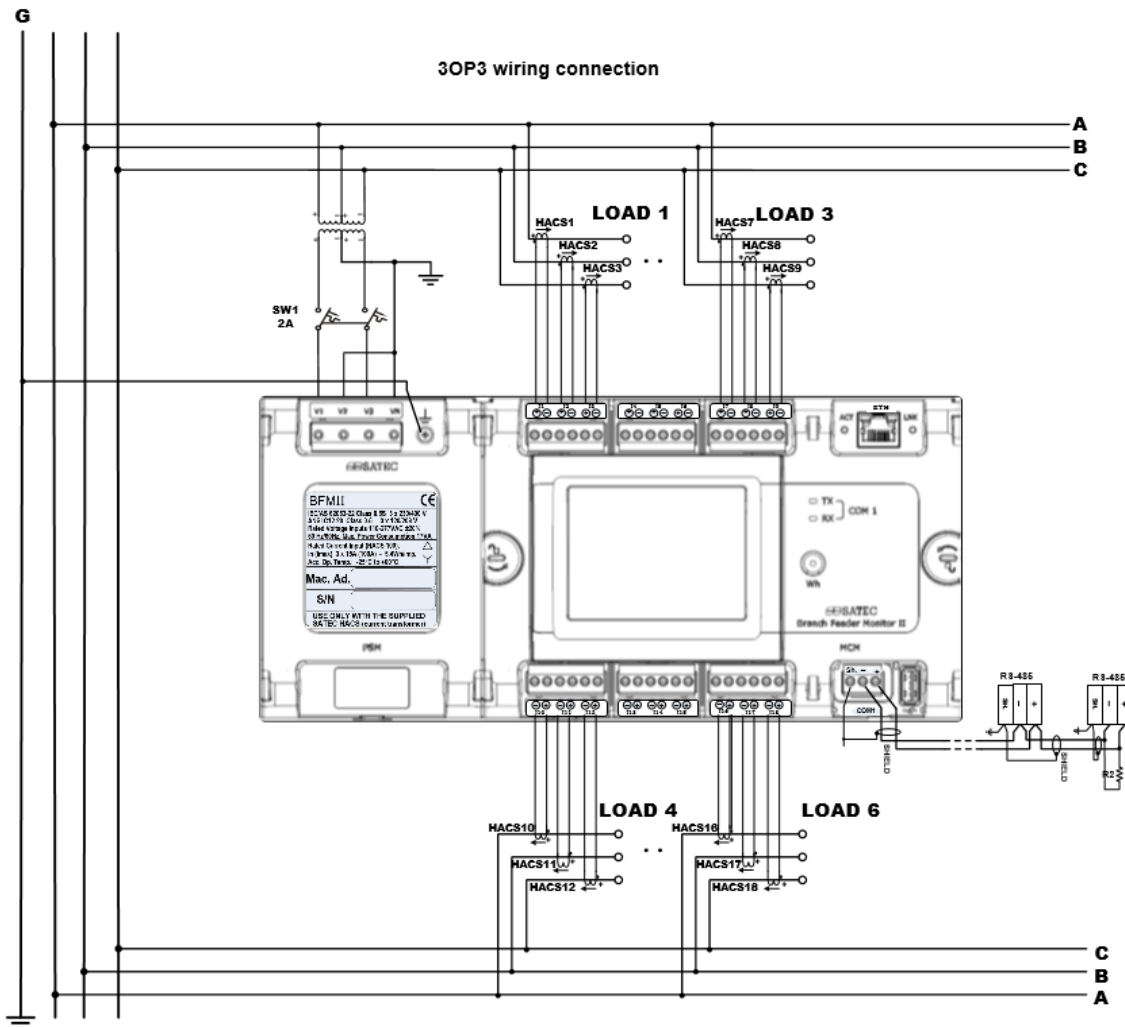

Figure 2-3d Typical Electrical Installation - 6 x 3 phase current input channels wiring - 3OP3

Maximum submeters wiring connection

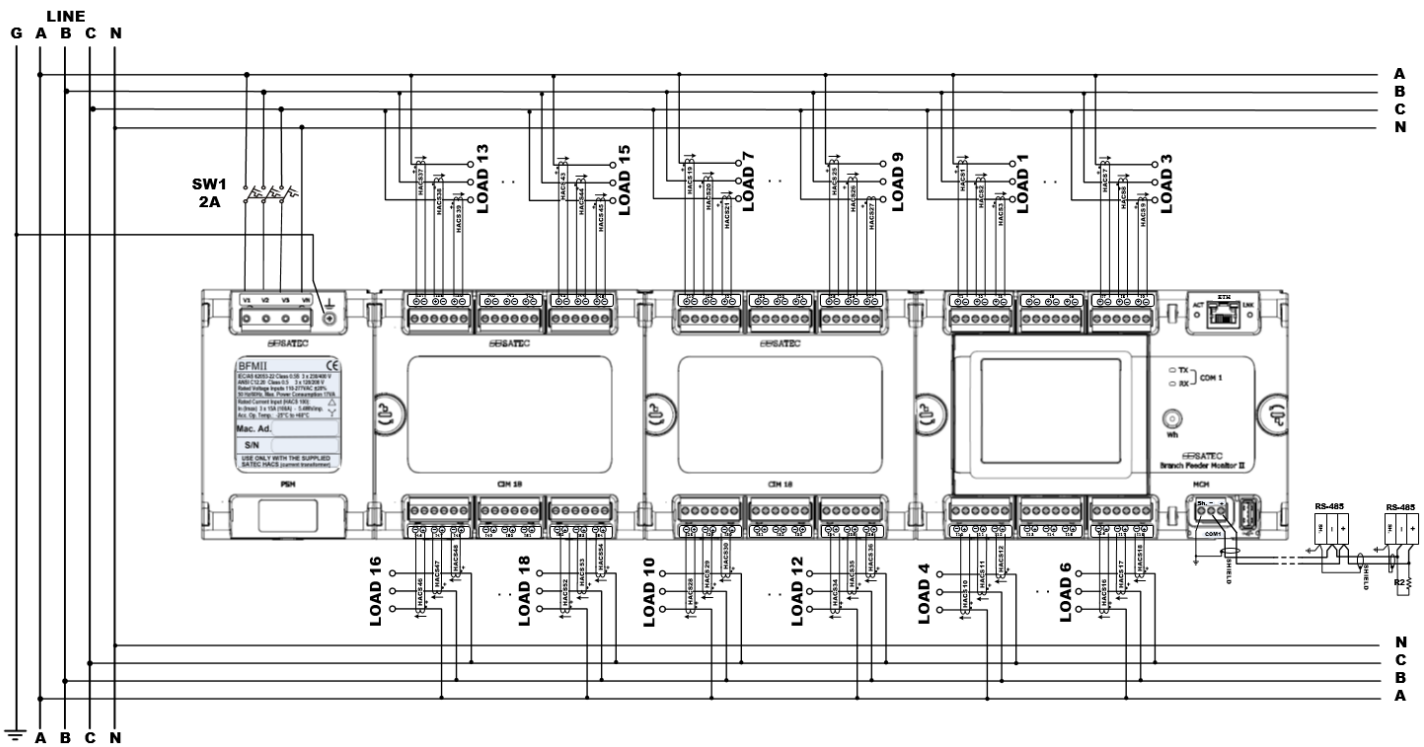

Figure 2-4a Typical Electrical Installation - 18 x 3 phase current input channels wiring
Installation with Auxiliary Power Supply

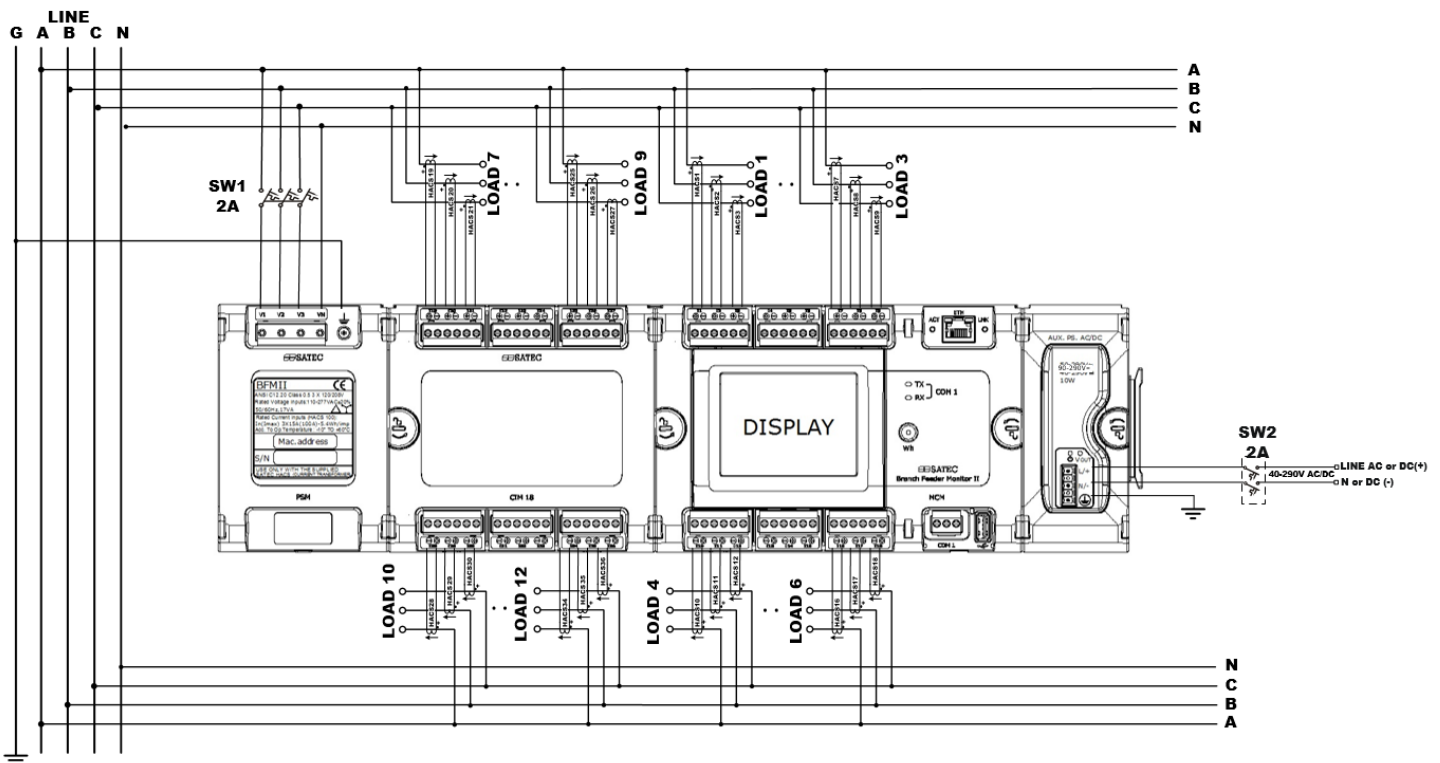

Figure 2-4b Typical Electrical Installation - 12 x 3 phase current input channels wiring with AC/DC Auxiliary Power Supply³

³ For operating temperature range of -20°C to 60°C, the Aux. PS can operate from 40VDC minimum at up to 54 channels

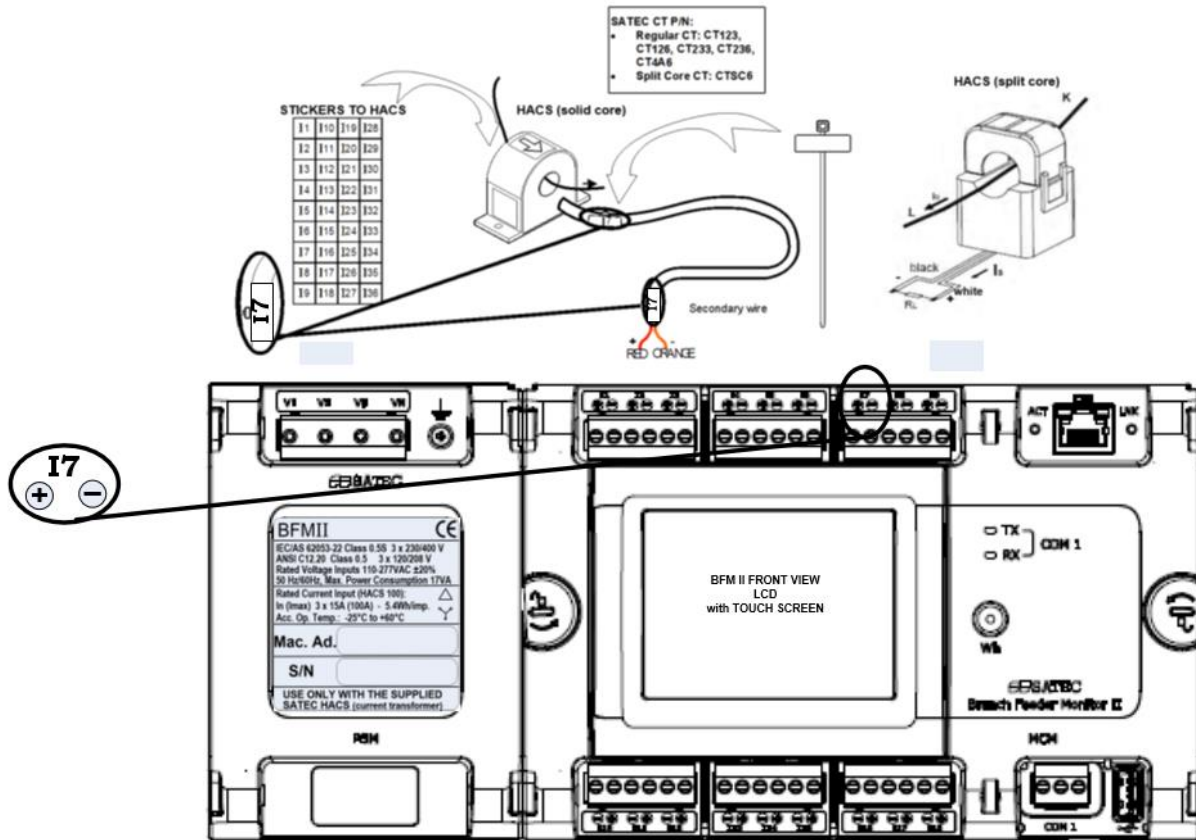

Figure 2-5 Single HACS wiring and labeling

USE ONLY WITH SUPPLIED BFM CURRENT TRANSFORMERS!

Connect the wires to the + and - inlets according to the following polarity colors:

Polarity	Solid Core HACS secondary	Split Core HACS secondary	Split Core RS5 secondary
+	RED	WHITE	WHITE
-	ORANGE	BLACK	BLACK

It is recommended to mark the cables and CTs with the supplied tie markers.

It is recommended to use non-insulated ferrules as wire terminal, such as: P/N: F77-8-M - Manufacturer: PANDUIT

HACS/RS5 stickers I1 through I54 correspond to the BFM II current inputs with matching labels. Cable stickers 1 through 18 correspond to the BFM II current terminal blocks with matching labels.

Use the table from Appendix B to annotate your input assignments and wiring connections.

Labeling example:

Assume you want to connect three HACSs/RS5s to the device terminal block 3 so these three HACSs/RS5s would be connected to the device inputs I7, I8, and I9 respectively:

1. Take a HACS/RS5 connection cable, attach a tie wrap marker to each side of the cable and mark them as 3 to indicate that it should be connected to the device terminal block 3.

For extended operating temperature range of -40°C to 70°C, the Aux. PS can operate from 90VDC minimum at up to 54 channels

- Put the HACs/RS5 label stickers 17, 18, and 19 directly on HACs/RS5s to indicate that these HACs/RS5s will be associated with the device current terminals 17, 18, and 19.

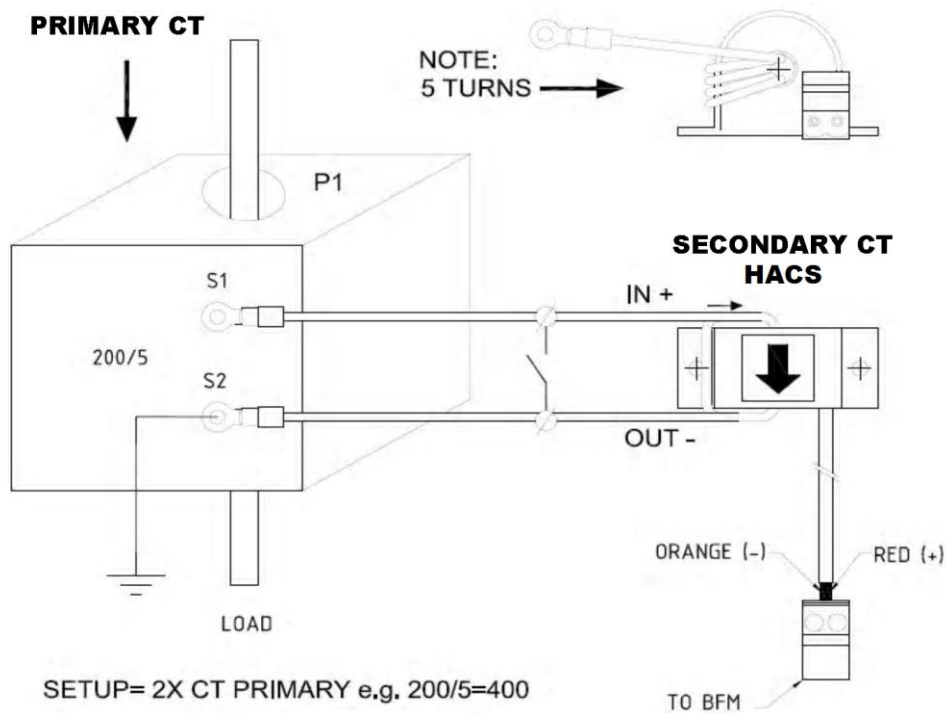

Figure 2-6 External CT connection to HACs/RS5

Safety requirements

The BFM II is designed with double insulation circuits to meet the safety requirements.

The properly marked external 3-pole disconnect device with circuit-breaker and a fuse 2A, 600V in every pole should be installed between voltage measurement terminals and power lines, located as close as possible (less than 2 m recommended) to the BFM II, as shown in figure 2-4a above .

EMI requirements

To ensure EMI (electro-magnetic interferences) requirements the BFM II must be grounded - the signal ground terminal should be connected to protective earth with a copper conductor or strap with minimal length (less than 1 m desirable) and cross-section AWG14-18 ($\approx 2.5 \text{ mm}^2$).

Sealing the BFM II

Every instrument external connections as Voltage Inputs terminals, Current Inputs terminals, COM1 terminal, USB and ETH connectors, can be sealed to avoid non-qualified technician to access these connections.

It is recommended to seal the BFM II after wiring the instrument.

To seal the instrument follow the instructions above:

1. Remove all terminal/connectors clear covers



2. Wire the terminal connections accordingly

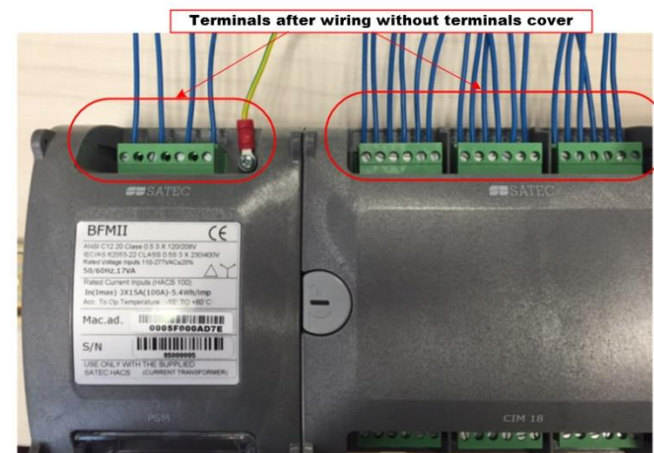

3. Mount clear terminals cover after wiring

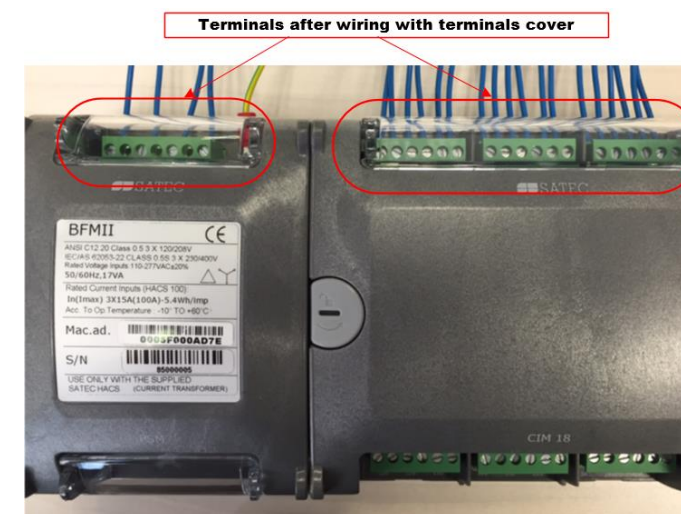

4. Attach the security seal cable lock to the terminals clear covers

Terminals Covers tied with security seal cable lock

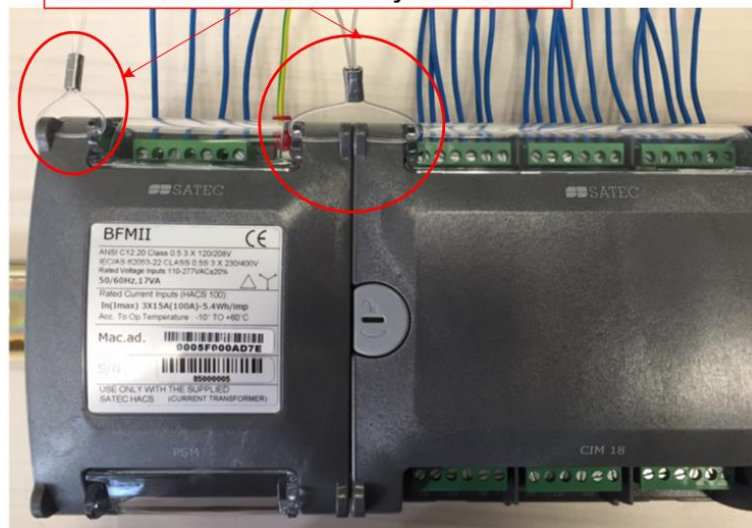

Communications

Serial Communication ports

The *BFM II* provides 2 optically isolated serial communication ports, *COM1* (RS485) in the MCM module and *COM2* (RS422/485) in one of the optional Communication modules (CELLULAR, WiFi⁴, BacNet³), as shown in *Figure 2-7a/b*.

Both COM ports can operate simultaneously.

If two or more communication modules are plugged in the BFM II, **only one COM2 port will be active**

RS-485 Connection – COM1 (standard)

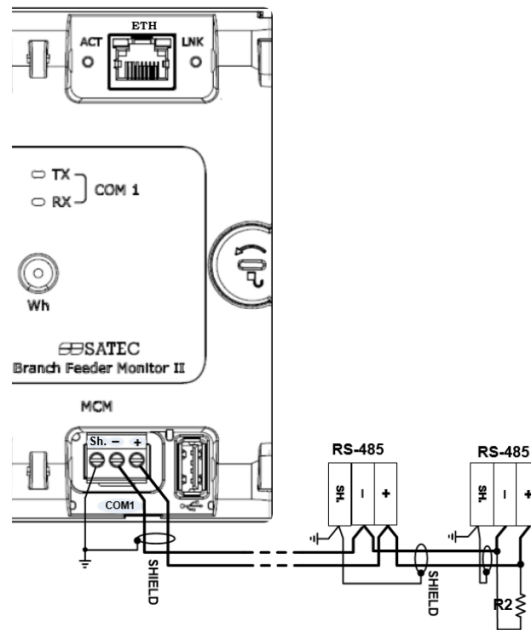

Figure 2-7a RS-485 3-wire connection - COM1

RS-422/485 Connection – COM2 (optional CELLULAR add-on module)

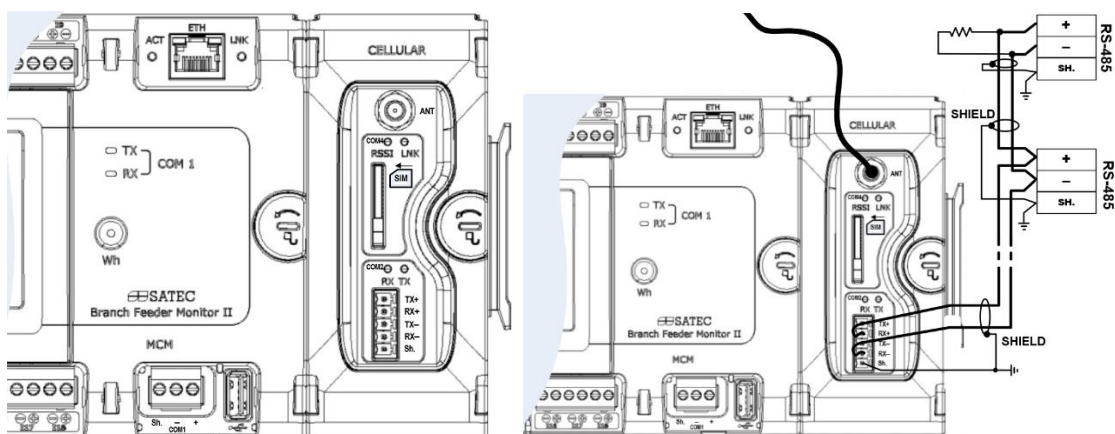

Figure 2-7b RS-485 3-wire connection - COM2

⁴ WiFi, Bacnet communication modules are not available – future options, contact SATEC for more details.

Network Communication ports

The BFM II provides an Ethernet connection as standard and optional public wireless network using the optional add-on CELLULAR module.

Both networks can operate simultaneously.

Ethernet Connection 10/100Base T (standard)

The *BFM II* provides one 10/100TX Ethernet communication port in the MCM module as standard, as shown in *figure 2-8*

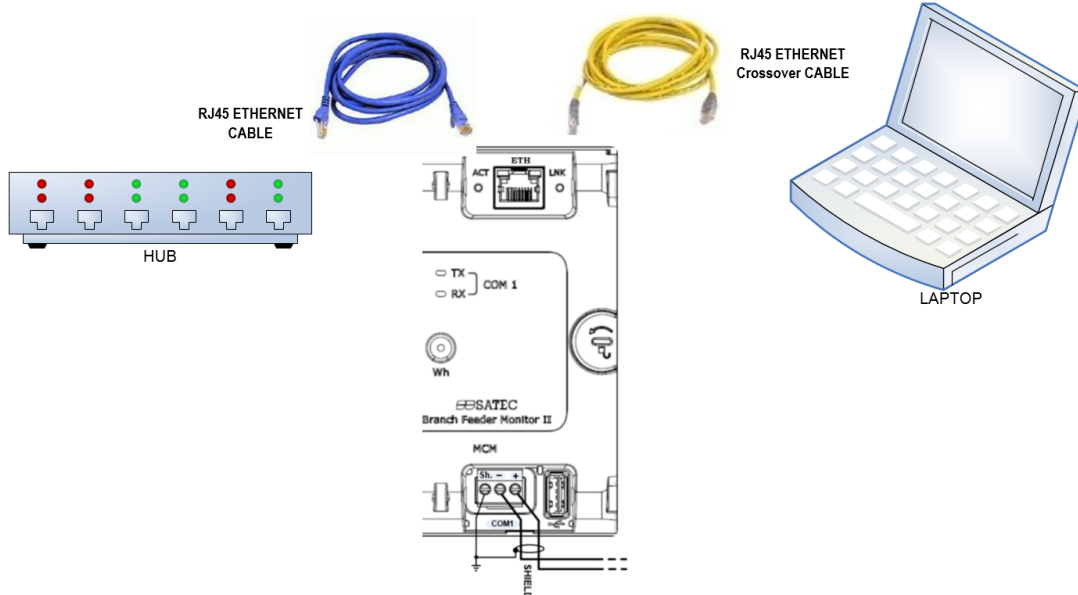

Figure 2-8 ETHERNET connection - RJ45 connector

Cellular module connection 2G/3G (optional)

The *BFM II* provides one 2G/3G Cellular communication using the CELLULAR module, as shown in *figure 2-9*.

Insert SIM card at the SIM card compartment, connect Antenna cable using SMA connector.

Only one CELLULAR module can be installed in the BFM II.

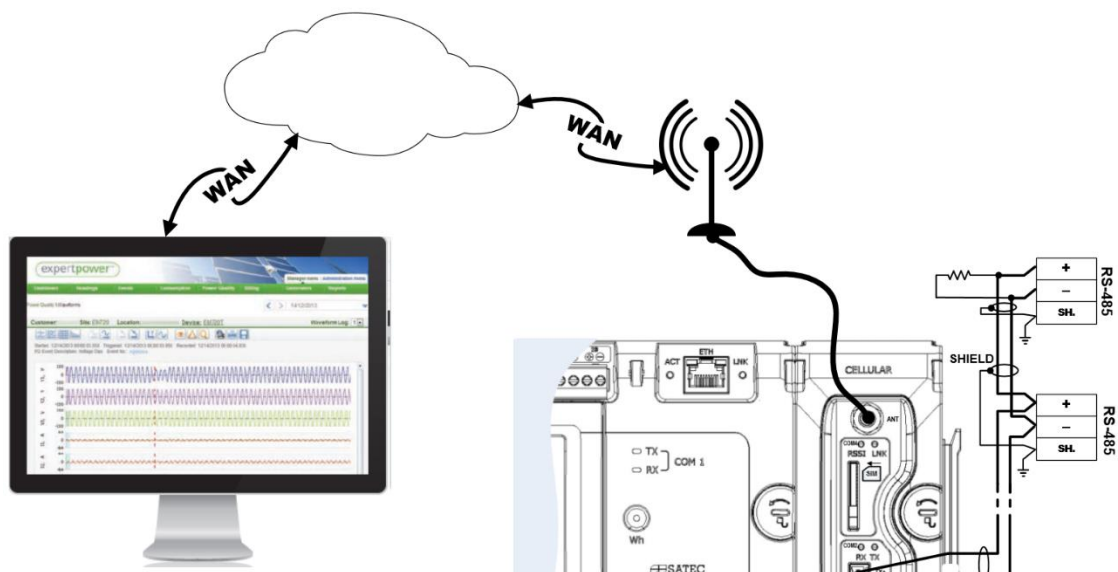

Figure 2-9 CELLULAR connection - SMA connector

USB Connection (standard)

The *BFM II* MCM module provides one galvanic isolated USB Device communication port, to be connected to a personal computer to run PAS™ configuration tool, as shown in *figure 2-10*.

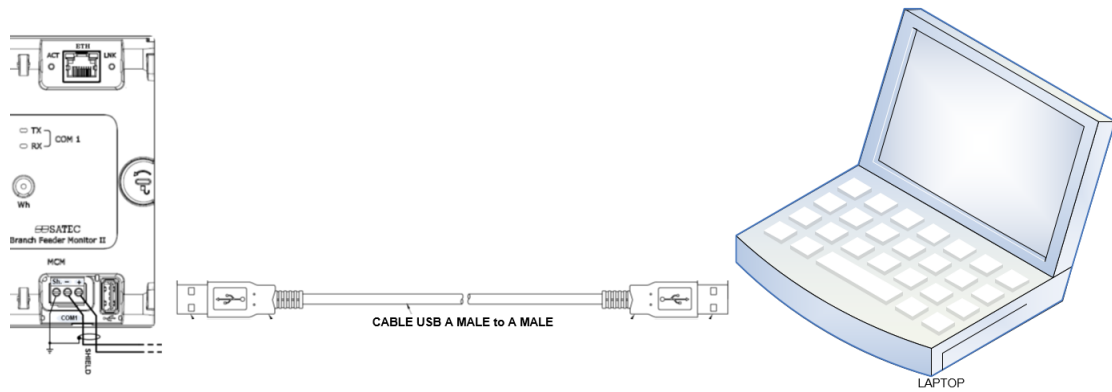

Figure 2-10 USB connection - Type A male

Input/Output

Digital Inputs

9 or 18 optically isolated digital inputs in one digital input module (9/18DI) are provided for status monitoring and external synchronization of power demand period and time. Dry or wet contacts may be connected to these inputs, as shown in *Figures 2-11*. All common terminals are internally connected together.

(See [Programming Digital Inputs](#) in Chapter 4)

Up to four 9/18DI modules can be installed in the BFM II.



Dry Contacts

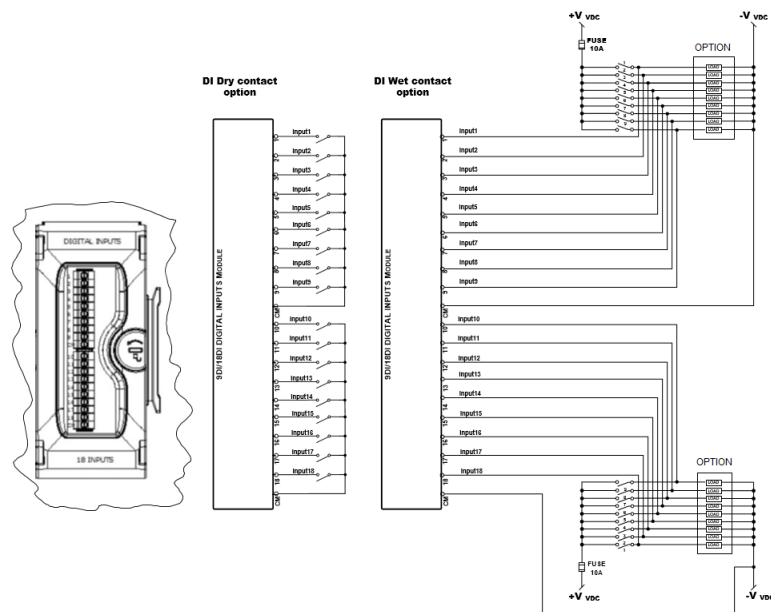
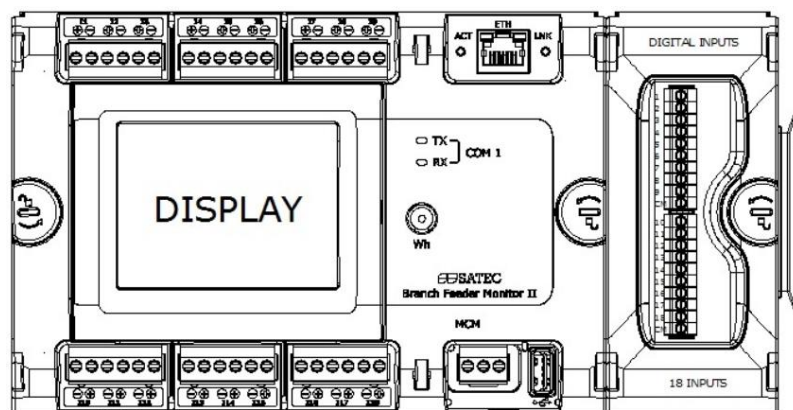

Figure 2-11 9/18 Digital Inputs Module connection

Relay Outputs

9 electro-mechanic FORM A relays in one relay output module (9RO) are provided to control external devices. Relay contacts may be connected as shown in *Figures*

2-12. Each relay contact can be controlled using MODBUS command through any BFM II communication ports.

Up to two 9RO modules can be installed in the BFM II

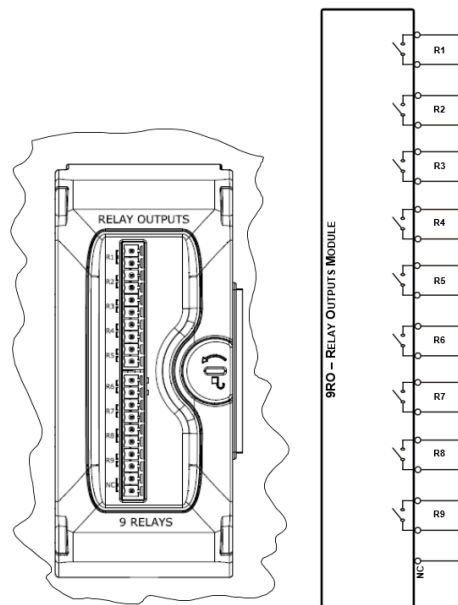
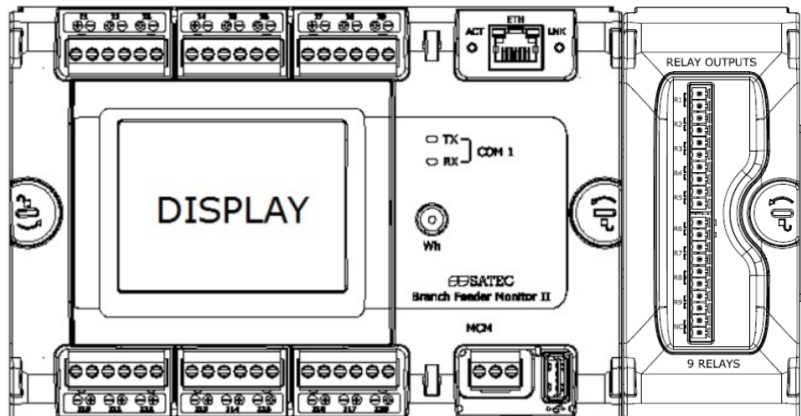

Analog Inputs

4 optically isolated analog inputs in one analog input module (4AI) are provided for sensor monitoring such temperature sensors, fuel level measurement, etc. ... Current input options are: 0-20 mA and 4-20 mA, 0-1 mA and ± 1 mA, as shown in Figure 2-12.

The scan time for regular analog inputs is 2 cycles (32 ms at @ 60Hz and 40 ms @ 50Hz). AI readings and triggers are updated each 1/2-cycle. Each analog input can be independently scaled to provide true readings in the user-defined engineering units (see [Programming Analog Inputs](#) in Chapter 4).

Up to two 4AI modules can be installed in the BFM II

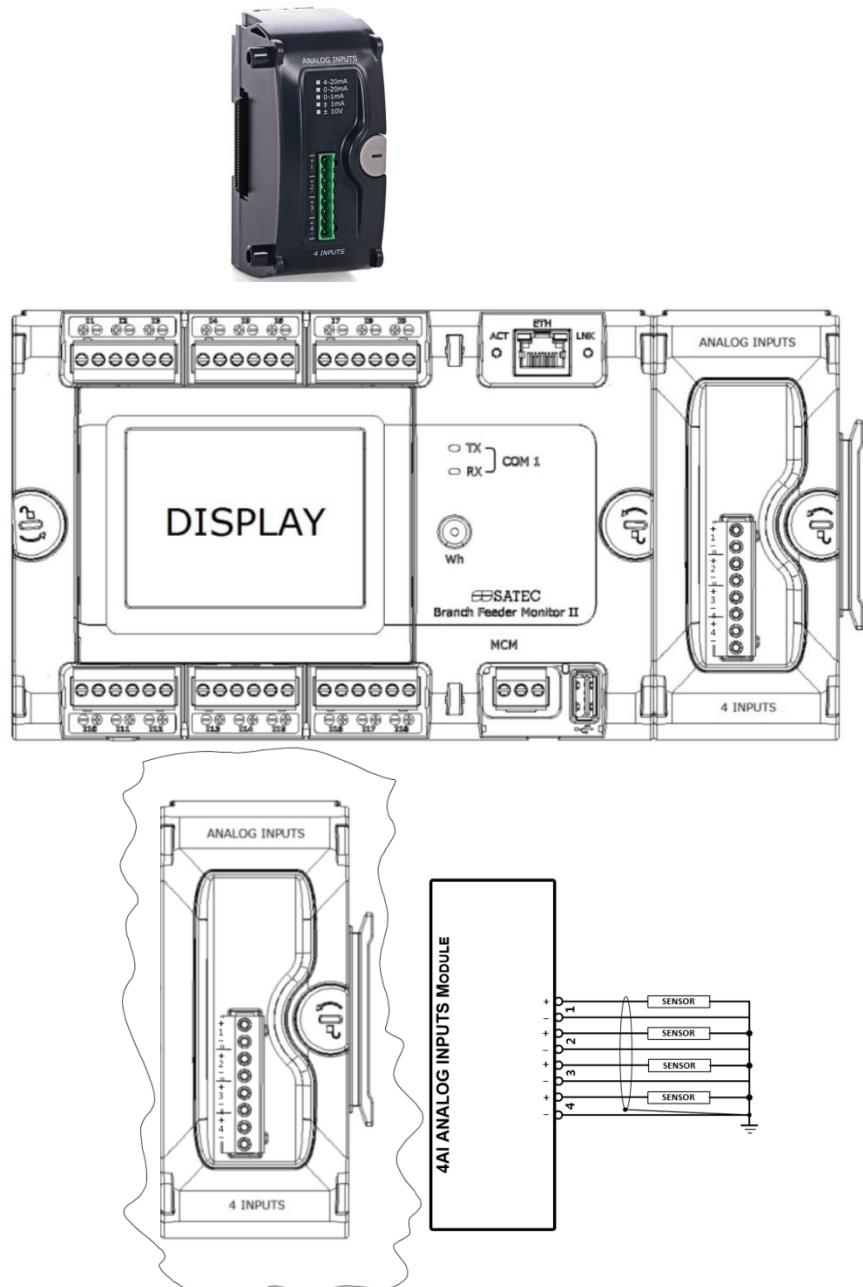

Figure 2-12 4 Analog Inputs Module connection

Installing the Battery backup

☞ The BFM II is packed without battery; therefore it must be installed by the installer during the BFM II installation.

After turning "ON" the BFM II power supply for the first time following battery installation, the BFM II initialization process duration may take about 7 minutes, while regular BFM II initialization process duration takes 40 seconds



Battery mounting/replacement instructions

Use CR2450 lithium 3.0 volt battery.

The battery can be replaced or installed while the BFM II power is "OFF"; after the BFM II Power Supply is turned "OFF" the battery can be replaced/installed in the coming 30 minutes without losing any data. The data may be uploaded and restored in a PC using PAS (see BFM II Operation Manual, Chapter 4) to avoid losing data.

When the battery level drops below the minimum allowed threshold, the "BATTERY LOW" flag is set and an event is generated in the "Event Log" memory, indicating that the battery should be replaced. Use the following procedure:

1. Remove the MCM lower terminal cover.



2. Remove the GDM tighten screw using a Philips screwdriver and pull the GDM unit to access the battery

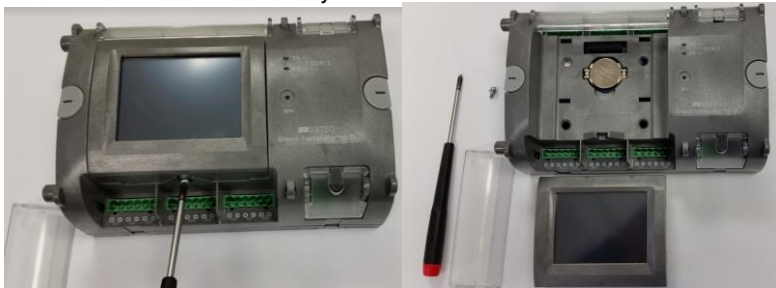

3. Remove the battery to be replaced and insert a new battery while the positive polarity (+) is on the top.



Controls and Indicators

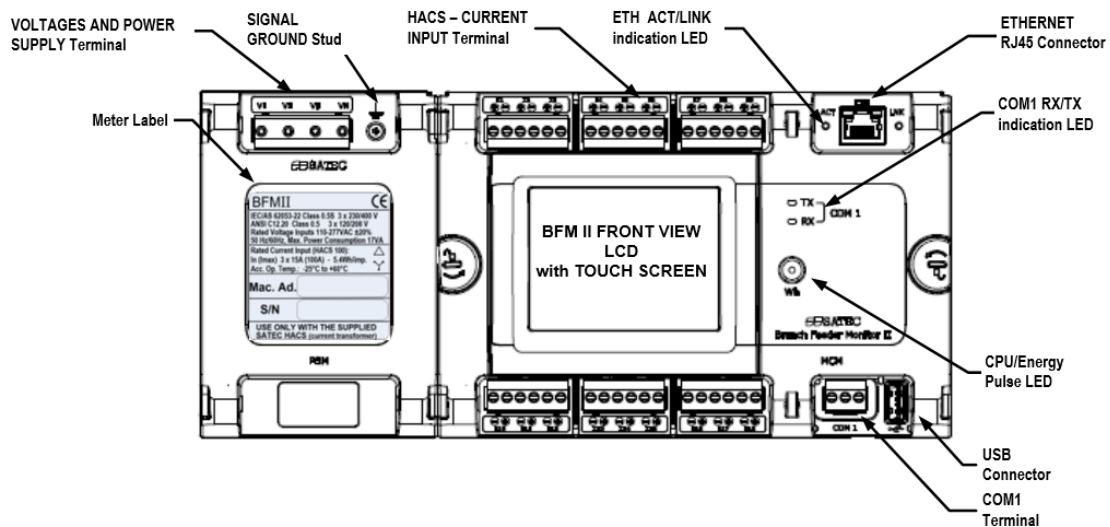

Figure 2-12 BFM II Front View

Indicator LEDs

The CPU/Energy Pulse LED, flashing green means CPU LED shows that the device is in initialization process after RESET or POWER ON. When device is ready for operation the LED is OFF, unless sub-meter SM #1 (after RESET or POWER ON Energy Pulse LED is assigned to SM#1 as default) is measuring energy consumption.

The green TX and RX LEDs indicate activity on the COM1 communication port. The LEDs flash when the port is receiving or transmitting data.

The green ACT and yellow LINK LEDs indicate Ethernet port activity and link to network

Energy Pulse LED

The CPU/Energy Pulse LED red means “Wh” LED flashes at a user-programmed rate when a load is applied to the device.

In normal mode (Energy Test LED is disabled), the LED pulses indicate imported or exported Wh for a selected submeter.

In energy test mode, the LED pulses indicate either imported Wh, or imported (inductive) varh for a selected submeter. Energy test mode is used for testing the device energy measurement accuracy. In test mode, the energy and demand accumulators do not account for consumed energy.

See [Device Options](#) and [General Meter Setup](#) in Chapter 3 on how to put the device into energy test mode and how to select the LED pulse rate and a submeter for testing.

Front Panel Display

The BFM II is provided with a graphical color LCD display and Touch Panel that is used for local meter reading and setup. See [BFM II Display Operations](#) in Chapter 3 for information on using the front panel display.

Communicating with the BFM II

Communication with the BFM II can be established independently and simultaneously through any communications port using the support PAS program supplied with the device or user application software. All communication ports are slave ports and have factory-preset parameters, such as baud rate, data format, and communications protocol that can be easily changed whenever desired.

COM1 and COM3 (standard), COM2 (optional) Serial Communications

The BFM II has three serial communication ports COM1 (standard) and COM2 (optional) for communicating with the master workstations, RTUs, PLCs or PAS™@ PCs, and COM3 with an optional remote display. The COM1 is an RS-485 2-wire port and COM2 ports can also be used for RS-422 four-wire communication. Local programming and upgrading the device firmware can be established by any communication port.

All ports are optically isolated and can operate at baud rates up to 115200 bps. Each port can be set up for any communication protocol supported by the BFM II independently from other ports. All ports are factory preset to 19200 bps, 8-bits/No-parity data format, and programmed for the Modbus RTU protocol.

The COM3 port has different connection terminals and is intended for communication with the optional Graphical Display Module (GDM).

See Configuring Serial Ports in Chapter 3/4 for information on how to set up serial ports in your device. For wiring diagrams, refer to [BFM II Electrical Installation chapter](#).

COM4 Port (optional)

The following plug-in modules are identified as COM4 port:

- Embedded 56K modem for communications through public telephone lines (MODBUS RTU/ASCII and DNP3.0 protocols) – **future**
- Embedded Cellular modem for communication through public cellular network (MODBUS/TCP and DNP3.0/TCP)
- Bacnet or LonWorks – **future**

USB Port (standard)

A USB node port is intended for local communications with the support PAS software. It is directly connected to your PC's USB port using the supplied USB cable. The USB communications does not require any settings. Just connect your PC to the BFM II USB port and install the supplied USB driver (see installing the USB Driver in Chapter 4). The USB communications is ten times faster than the serial communications can provide at a maximum baud rate.

Ethernet Port (standard)

A 10/100Base-T Ethernet port provides a direct connection of the BFM II to a local area network through the TCP/IP protocols. The device has three onboard TCP servers configured for the Modbus/TCP (at TCP port 502), DNP3.0/TCP (at TCP port 20000) and IEC 60870-5-104 (at TCP port 2404) communications. The TCP servers can support up to 5 simultaneous connections with MODBUS/TCP and DNP3.0/TCP.

Connection through the Ethernet port does not require device identification. The BFM II responds to any device address and returns the received address in the response message.

Note

To provide simultaneous file services for all ports, the BFM II keeps independent file pointers for each communications port. For a TCP port, the BFM II holds separate file pointers for each active TCP socket. The TCP server automatically closes a connection if a socket is idle for more than 5 minutes. There is no guarantee that a new connection is established at the same socket, so do not make any assumptions regarding the current file status when starting a new connection from your application. Always initialize a file pointer to a record from where you expect to begin reading a file. For more information, see "File Transfer" in the BFM II MODBUS Communications Guide.

Wireless Ethernet Port – WiFi (optional)

(Future)

A second Ethernet port for LAN backup is available in plug-in module. As default the standard Ethernet port is active, if this link is down the second optional Ethernet port will switch on automatically to provide LAN access through it. The second Ethernet port is a wireless IEEE 802.11 b/g.

It provides a direct connection of the BFM II to a local area network through the TCP/IP protocols. The device has two onboard TCP servers configured for the MODBUS/TCP (at TCP port 502) and DNP3.0/TCP (at TCP port 2000) communications. The TCP servers can support up to 5 simultaneous connections with MODBUS/TCP and DNP3.0/TCP client applications.

Connection through the Ethernet port does not require device identification. The BFM II responds to any device address and returns the received address in the response message.

CELLULAR Port (optional)

A 2G/3G Cellular modem port provides a direct connection of the BFM II to a public area cellular network through the TCP/IP protocols. The device has two onboard TCP servers configured for the Modbus/TCP (at TCP port 502) and DNP3.0/TCP (at TCP port 20000) communications. The TCP servers can support up to 5 simultaneous connections with MODBUS/TCP and DNP3.0/TCP client applications.

Connection through the CELLULAR port does not require device identification. The BFM II responds to any device address and returns the received address in the response message.

Using the GDM (optional)

The Graphical Display Module (GDM

The remote display modules communicate with the BFM II using the MODBUS RTU protocol. Both the COM3 port and the GDM COM port are preset at the factory to 19200 bps, 8-bits/No-parity, address 1, and run the MODBUS RTU protocol. The baud rate can be increased up to 460,800 bps (depending on the communications quality) through the GDM or service Terminal program.

Using PAS

PAS is the support software supplied with the BFM II that gives the user basic tool for programming the device, performing remote control operations, monitoring real-time measurements, retrieving and analyzing historical data files.

PAS can communicate with the devices through any BFM II port using the MODBUS RTU, MODBUS ASCII and DNP3.0 protocols.

For information on installing and using PAS, see Chapter 4 “[Using PAS](#)”.

Device Settings

Before operating your BFM II, provide the device with information about your particular environment. The device front display (see [Display Operations \(BFM II\)](#)) and the supplementary PAS software (see [PAS Application Software](#)) allow you to configure the BFM II for your particular use.

Meter Security

The BFM II provides 3-level password security for protecting meter setups and accumulated data from unauthorized changes. Meter readings are not software protected.

Access to particular setup and control items is granted depending on the security level of the password you entered. The passwords can be 1 to 8 digits long.

The following table shows the meter security levels and user access rights.

Password	Security Level	Access Rights
Password 1	Low	Reset of billing and engineering maximum demands, and device diagnostics. Meter clock update. Display setup.
Password 2	Medium	TEST mode. Reset counters and pulse counters. Communications setup. I/O operation setup and control. Memory and recorders setup. Billing/TOU system setup.
Password 3	High (Administration level)	Meter passwords setup. Basic device setup. Device energy and power options setup. Reset of conventional log files.

The meter is primarily shipped with all passwords preset to 9 at the factory. It is highly recommended that you change the factory set passwords as fast as possible. See [Administration](#) in Chapter 4 on how to change passwords in your meter.

Password-tampering events are automatically recorded to the Event log file after every three unsuccessful login attempts in 5 minutes.

Submeter System

The BFM II provides up to 54 submeters with separate measurement and energy registers. Each submeter can service current inputs dedicated to a particular consumer (metering submeter) or be used as a Totalization meter for automatic Totalization of energy from different sub-consumers (Totalization submeter). Additionally, the BFM II provides four more Totalization submeters (55 through 60) that you can use for Totalization purposes when all 54 metering submeters have been utilized.

A submeter remains inactive while there are no current inputs associated with the submeter (see [Channel Assignments](#)), or until you link another submeter as a source to its energy registers making it a Totalization submeter (see [Setting up Total and Tariff Registers](#)). The Channel Assignment setup allows you to link one to three current inputs to each submeter and to specify the primary rating of the current transformers. A Totalization submeter provides Totalization of energy from any number of metering and Totalization submeters.

By default, your device is configured for 6 three-phase metering submeters with CT primary value of 50A (50A nominal rating) - 100A maximum current inputs for MCM model - HACS, in direct connection application, or 10A (10A nominal rating) - 20A maximum current inputs for MCM model - RS5, in transformer operated application.

Submeter Addressing

The BFM II uses the Modbus communication protocol for data transmission and accessing setups through communications. A full description of the communications protocol is found in the BFM II Modbus Reference Guide provided with your device. Each active submeter in the BFM II is assigned a unique communication address that allows accessing its private registers and setups. All submeter addresses are assigned automatically in a sequential order starting with the device base address that is programmed through the device Communication Setup (see [Setting Up Communication Ports](#)). The following table illustrates submeter addressing in the device with the base address N.

Device Base Address	Submeter Number	Submeter Address
N	SM 1	N
	SM 2	N+1
	...	
	SM 54	N+53
	SM 55	N+54
	...	
	SM 60	N+59

Your device is factory preset to address 1 and occupies the range of addresses 1 through 6, configured for 6 three-phase submeters.

NOTES

- Device setup settings, excluding the alarm setpoints and data log setup, are shared across all submeters. Though you can read or write them using any submeter address, your changes affect all submeters in the device.**
- When using the expertpower™ client, submeter address 99 on the Ethernet port is reserved for the BFM II router and must not fall inside the range of the submeter addresses for this port.**

Select your submeters (both metering and Totalization) in a sequence without gaps so that your device does not occupy unnecessary network addresses.

If you connect a number of devices to a serial network, allocate a range of addresses for each device so that they do not overlap. For example, if you use three devices with 18 submeters in each one, assign the base address 1 to the first device, the address 19 to the second, and the address 37 to the third device so that they will occupy three non-overlapped address ranges 1 through 18, 19 through 36, and 37 through 54.

Basic Device Settings

For proper device operation, select the correct power frequency (see [Basic Meter Setup](#)) and set the correct primary ratings for device current inputs (see [Channel Assignments](#)) before you connect the device to your network.

Energy/TOU System

The BFM II provides 8 separate billing energy (total/summary and parallel tariff and maximum demand) registers for each individual submeter. Each register can be linked to any internal energy source or another submeter. The first billing register in your meter is linked to the kWh accumulator by default. Other registers are not operational unless you configure them through the Energy/TOU Setup (see [Configuring Billing Energy and TOU Registers](#)).

Tariff Rates

The BFM II provides three options for switching tariff rates:

- Automatic via a programmable TOU calendar schedule Modbus RTU and Modbus ASCII communication protocols
- external via communications by direct writing a tariff number to the meter tariff register
- external via digital inputs by providing a tariff number code on the meter tariff inputs

See [Device Options and Mode Control](#) in Chapter 4 on how to program the tariff control mode and select tariff inputs in your meter.

The meter tariff structure supports 8 different tariff rates using an arbitrary tariff schedule.

The BFM II TOU calendar provides a season tariff schedule and an option for scheduled daylight savings switch dates. A total of 4 types of days and 4 seasons are supported with up to eight tariff changes per day. See [Configuring Billing Energy and TOU Registers](#) for more information on programming the tariff calendar schedule in your meter.

The present tariff rate is indicated on the BFM II display. If required, tariff-switching pulses with a programmable duration can be output via the meter relays.

Fault Recording

The programmable Fault recorder records time-tagged fault events into the fault event report. It can be triggered externally through any digital input or internally from the embedded fault detector. The internal fault detector can automatically detect different fault categories using the device's own sub-cycle measurements. The fault triggers have programmable thresholds and hysteresis that can be adjusted for specific substation conditions.

The Fault recorder can be programmed to trigger the Waveform recorder and Data recorder to record input waveforms and long-duration RMS trends during the time of the fault.

Harmonic Measurements

The PM180 provides harmonic measurements on three voltage channels V1-V3 and three standard range (20A/10A) current channels I1-I3. To avoid erroneous harmonic readings when the high fault currents saturate current channels, the harmonics registers are not updated at the time of the fault.

The FFT analysis is performed over a 2-cycle waveform for 50Hz and 12-cycle waveform for 60Hz system, sampled at a rate of 64 samples per cycle. This gives spectrum components up to the 25th harmonic.

The following table lists harmonic quantities provided by the device.

Parameter	Label
Total Harmonics	
Voltage THD	V1 THD – V3 THD
Current THD	I1 THD – I3 THD
Current TDD	I1 TDD – I3 TDD
Current K-factor	I1 KF – I3 KF
Individual Harmonics	
V1 Odd/even-harmonic distortion	V1 %HD1 - V1 %HD25
V2 Odd/even-harmonic distortion	V2 %HD1 - V2 %HD25
V3 Odd/even-harmonic distortion	V3 %HD1 - V3 %HD25
I1 Odd/even-harmonic distortion	I1 %HD1 - I1 %HD25

Parameter	Label
I2 Odd/even-harmonic distortion	I2 %HD1 - I2 % HD25
I3 Odd/even-harmonic distortion	I3 %HD1 - I3 % HD25
Symmetrical Components	
Positive-sequence voltage	V PSEQ
Negative-sequence voltage	V NSEQ
Zero-sequence voltage	V ZSEQ
Negative-sequence voltage unbalance	V NSEQ UNB%
Zero-sequence voltage unbalance	V ZSEQ UNB%
Positive-sequence current	I PSEQ
Negative-sequence current	I NSEQ
Zero-sequence current	I ZSEQ
Negative-sequence current unbalance	I NSEQ UNB%
Zero-sequence current unbalance	I ZSEQ UNB%
Fundamental Phasors	
Voltage magnitude	V1 Mag – V3 Mag
Current magnitude	I1 Mag – I3 Mag
Voltage angle	V1 Ang – V3 Ang
Current angle	I1 Ang – I3 Ang

The device provides individual voltage and current harmonic measurements both in percent of the fundamental component, and in corresponding engineering units. Quantities in engineering units are calculated only for odd harmonics. Angles for phasor vectors are given relative to the V1 phase voltage.

Billing Data Recording and Load Profiling

The BFM II provides automatic recording of the billing data to flash files for each submeter/virtual meter:

- Daily energy and maximum demand profile for the last 500 days
- 15-min energy load profile for 150 days or 30-min profile for 300 days

Device Diagnostics

Device diagnostic messages may appear as a result of the BFM II built-in diagnostic tests performed during start-up and device operation. See [Device Diagnostic Codes](#) in Appendix F for the list of diagnostic codes and their meanings.

The device diagnostics status is stored in a non-volatile register, which may be inspected and cleared via PAS, from the meter display or from a user application. All diagnostic events with time stamps are also recorded in the device Event log and can be inspected via PAS (see [Retrieving the Event Log](#) in Chapter 4).

See [Diagnostics Display](#) and [Reset](#) in Chapter 3 on how to inspect and clear the device diagnostics status from the display. See [Viewing and Clearing Device Diagnostics](#) in Chapter 3 on how to inspect and clear the device diagnostics status via PAS. Refer to the BFM II Modbus Reference Guide for the diagnostic register address and layout.

In the event of a device fault, check the fault reason and clear the device diagnostics. In the event of a time fault, update the device clock. In the event of a configuration reset, check the setup affected by the fault via the device Event log, and then verify the setup data.

Hardware failures are normally non-critical recoverable faults that do not cause a system failure but may cause data loss. Hardware failures are often caused by excessive electrical noise in the region of the device.

If the device continuously resets itself, contact your local distributor.

Monitoring Meter Batteries

A backup lithium battery keeps the meter clock running when the meter goes to standby after the main power is OFF.

When the lithium battery voltage drops below the minimum allowed level, it is indicated in the device diagnostics. In this event, the battery should be checked and replaced if required.

Billing Data Display

The BFM II display submeter indicates billing energy, maximum demand and cumulative maximum demand registers for the present billing period and for three previous billing periods.

The display is automatically configured for your set of billing registers and your tariff schedule. See [Billing Period Data Displays](#) in Chapter 3 for the display layout.

Chapter 3 BFM II Graphical Display Operations

Startup Diagnostics



After applying power to the meter, a start-up message is displayed for one second. "Initialization in progress ..." indicates a normal power-up sequence. After initialization is completed, the instrument will display default screen including status bar as shown below.

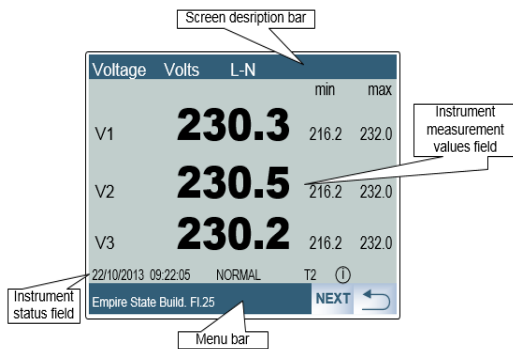

The screen description bar represents the page name and parameters/functions to be displayed.

The instrument measurement values field displays the parameters/functions values.

The instrument status field show following indications:

- Present date and time
- Energy calculation mode - Normal or Test
- If diagnostics message is created the "i" is displayed

You can observe the list of device diagnostic codes recorded during restart and device operation via the [Status Display](#).

See [Device Diagnostic Codes](#) in Appendix F for the list of diagnostic messages.

Display Features

The multifunctional TFT Graphical LCD Display Module (GDM) with backlight allows easy read outs of the measurement parameters both in the dark and under sunlight. The menu-driven multi-page display allows viewing numerous measurement parameters by scrolling through display screens and pages using Touch Panel buttons.

Submeter Displays

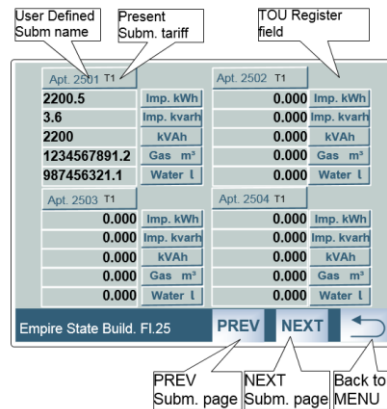

In display mode, the display shows readings for the currently selected submeters' page. Its number or name is indicated at each submeter upper bar of the display block. To scroll through more active submeters pages, press to PREV/NEXT buttons.

Display Update

The display is updated by default once per second; you can adjust the display update rate via the Display Setup Menu.

Auto Return

(future)

If no buttons are pressed for 5 minutes and the display Auto Return option is not disabled, the display will automatically return to the real-time screen mode from any other measurement display or programming mode. The Auto Return option can be disabled through the Display Setup Menu.

Auto Scroll

(future)

If no buttons are pressed for 30 seconds while the display is in the real-time screen mode, and the Auto Scroll option is enabled in the BFM II, the measurement display will scroll automatically through all submeters. The scroll interval can be adjusted through the Display Setup Menu. To stop auto scrolling, press any button.

Backlight

If no buttons are pressed for 1 minute, the BFM II turns the backlight off. To restore the backlight, press any button briefly.

Navigation Buttons

The BFM II GDM is equipped with Touch Panel (TP) buttons. The TP buttons allow you to navigate through device setup menus and to change the device settings.

The BFM II display has several multi-page screens for viewing numerous measurement parameters shown in the following screens. Scroll through the screen modes by pressing the relevant soft-key Menu button.

Measurements Views

The BFM II measurements display views permits to navigate to all measured and calculated parameters

Consumption views

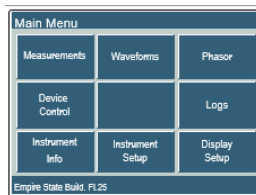

Pressing to “Measurements” button from Main Menu screen, allows you to access all measured parameters screen

↓ Pressing “Measurements” button

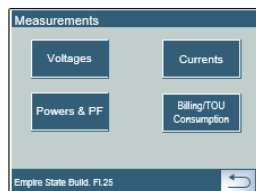

Pressing “Billing/TOU Consumption” button, shows present period total¹ TOU energy usage and maximum/cumulated power consumption registers “reg1”. Navigating with “PREV”/“NEXT” buttons will display present period of total registers “reg1-8”

↓ Pressing “Billing/TOU Consumption” button

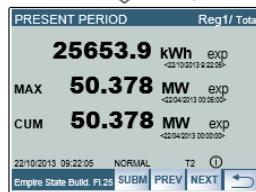

Pressing “SUBM” button, shows submeters TOU usage registers as imp. or exp. kWh, imp. or exp. kvarh, gas and/or water consumption (up to 5 registers per submeters can be displayed) for specific Tariff rate, each page represents 4 submeters designated by user defined submeter name.

Pressing “PREV” or “NEXT” button will navigate over all submeters pages

↓ Pressing “SUBM” button

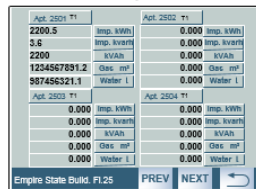

Pressing “MENU” button will move to Measurements menu screen.

¹ Total TOU energy usage and maximum/cumulated power consumption registers “reg1” represents the first Submeter (SM1). It is recommended to assign the first submeter to the distribution node of the facility.

Voltages views

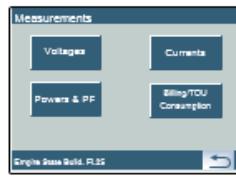

Pressing "Voltages" button

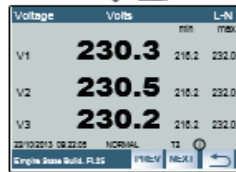

Pressing "NEXT" button

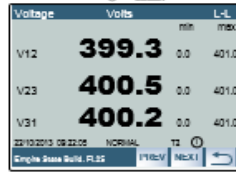

Pressing "NEXT" button

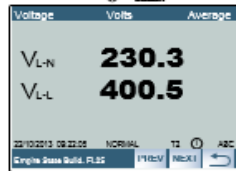

Pressing "NEXT" button

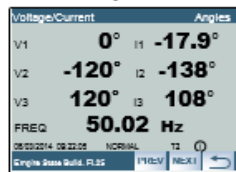

Pressing "NEXT" button

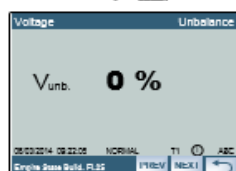

Pressing "Voltages" button, shows three phase voltage measurements with minimum maximum value from last slide window, first "Voltages" page shows Line-to-Neutral phase voltage. This screen is also the default screen appearing after Power UP or Instrument Reset

This page also shows status bar including current date and time, mode status (NORMAL or TEST), tariff no., diagnostic indication and 3 phase order indication.

Pressing "NEXT" button will show Line-to-Line voltage

Pressing "NEXT" button will show Line-to-Neutral and Line-to-Line average voltage

Pressing "NEXT" button will show 3 phase voltage/current angles and frequency measurement.

Pressing "NEXT" button will show voltage unbalance

Pressing "MENU" button will move to Measurements menu screen

Current views

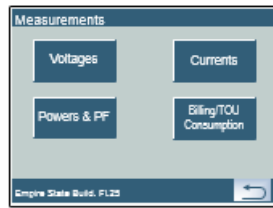

Pressing "Currents" button

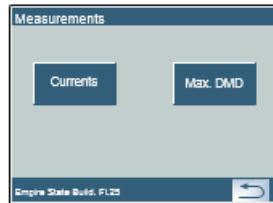

Pressing "Min./Max." button

Current	Amps	min/max		
Apt. 3501		Apt. 3502		
I1	199.3	0.1 200.2	I10	199.3 0.1 200.2
I2	199.3	0.1 200.2	I11	199.3 0.1 200.2
I3	199.3	0.1 200.2	I12	199.3 0.1 200.2
Apt. 3503		Apt. 3504		
I4	199.3	0.1 200.2	I13	199.3 0.1 200.2
I5	199.3	0.1 200.2	I14	199.3 0.1 200.2
I6	199.3	0.1 200.2	I15	199.3 0.1 200.2
00/09/2013 09:22:05 NORMAL T2				

Pressing "Max.DMD" button

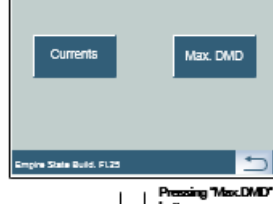

Pressing "Max.DMD" button

Current	Amps	Max. DMD		
Apt. 3501		Apt. 3502		
I1	199.3	00/00/12:00:00	I10	199.3 00/00/12:00:00
I2	199.3	00/00/12:00:00	I11	199.3 00/00/12:00:00
I3	199.3	00/00/12:00:00	I12	199.3 00/00/12:00:00
Apt. 3503		Apt. 3504		
I4	199.3	00/00/12:00:00	I13	199.3 00/00/12:00:00
I5	199.3	00/00/12:00:00	I14	199.3 00/00/12:00:00
I6	199.3	00/00/12:00:00	I15	199.3 00/00/12:00:00
00/09/2014 09:22:05 NORMAL T2				

Pressing "Currents" will move to Min/Max and Max DMD screen menu.

Pressing "Min./Max." button, shows submeters Current consumption with min/max values.

Pressing "PREV" or "NEXT" button will scroll over all submeters current measurement pages.

Red current values designate reverse current installation

Pressing "MENU" button will move to Min/Max and Max DMD menu screen

Pressing "Max. DMD" button, shows submeters Current consumption with maximum demand values with time stamp.

Pressing "PREV" or "NEXT" button will scroll over all submeters current measurement pages.

Pressing "MENU" button will move to measurements screen

Powers and PF views



Pressing "Powers & PF" button will move to Min/Max and Max DMD screen menu.



Pressing "Min./Max." button, shows total powers and PF measurements with min/max values.



Pressing "SUBM" button, shows submeters current active and reactive powers and power factor. Pressing "PREV" or "NEXT" button will scroll over all submeters powers measurement pages.

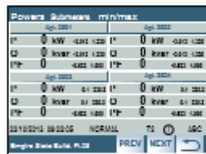

Pressing "MENU" button will move to Min/Max and Max DMD menu screen



Pressing "Max. DMD" button, shows submeters Current consumption with maximum demand values with time stamp.



Pressing "SUBM" button, shows submeters present period active, reactive and apparent powers.



Pressing "PREV" or "NEXT" button will navigate over all submeters powers measurement pages.

Pressing "MENU" button will move to measurements screen

Device Control views

The BFM II Device control display views permits to display instrument diagnostic status. It shows device diagnostic messages recorded as a result of the meter self-test diagnostics during start-up and operation. The diagnostics page is only displayed if errors were detected.

See [Device Diagnostic Codes](#) in Appendix F for the list of diagnostic codes and their meanings. See [Device Diagnostics](#) in Chapter 3 for more information on the BFM II built-in diagnostics. See [Reset](#) in Chapter 3 on how to clear the device diagnostics status from the display.

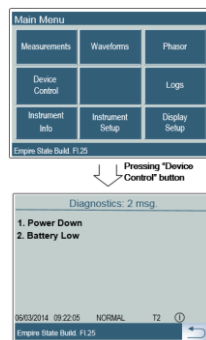

Pressing “Device Control” button will move to measurements screen

Diagnostics screen showing

Instrument Info views

The BFM II instrument information menu displays the whole instrument information in terms of factory data, available communication ports and instrument resources.

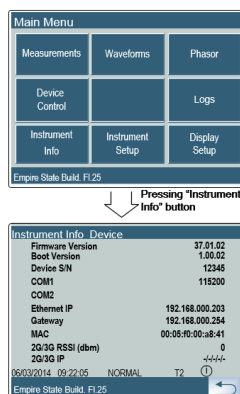

Pressing “Instrument Info” button will display the first information screen showing factory data as device serial number, product, calibrated and operation starting dates, etc ...

Waveforms views

The BFM II instrument waveforms menu displays the three-phase voltage and current channels waveforms, the represented current channels are the first three-phase current channels (I1-I3). The display is refreshed every second.

Note: Harmonics display will be supported from BFM II phase II.

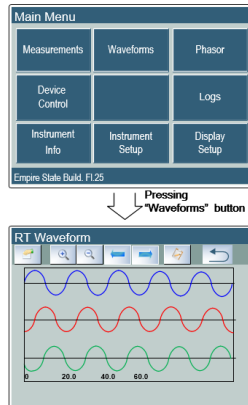

Pressing "Waveforms" button will display three-phase Voltage Real Time waveforms.

Pressing the WF ch. selection button will display voltage and current channels waveforms to be displayed.

Pressing (+) or (-) Zoom buttons will increase or decrease the time base display.

Phasor views

The BFM II instrument Phasor menu displays the three-phase voltage and current channels Phasor, the represented current channels are the first three-phase current channels (I1-I3). The display is refreshed every second.

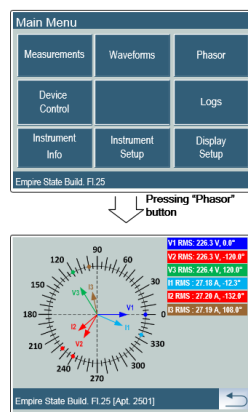

Pressing "Phasor" button will display three-phase Voltage versus Current Phasor. It will display the three phase current channels according to selected Sub Meter.

Logs views

The BFM II instrument Logs menu displays the instrument Event log history within a predefined date period.

Instrument Setup

The BFM II setup is menu-driven. To enter the setup menus, press the “Instrument” or “Display” setup buttons.

The BFM II setup capability using the instrument interactive display is limited to user level setups only and only if “front panel security” class is in full access mode. See Display Setup using PAS.

Entering a Password

The setup menus are secured by an 8-digit user password. If the password entered is correct, you will move to the main setup menu, otherwise you will return to the Main Menu screen.

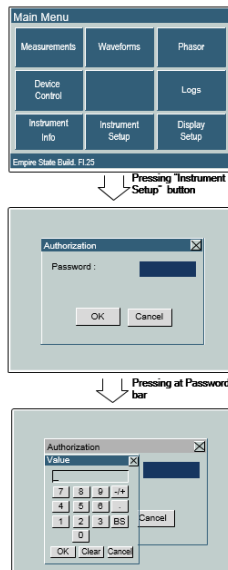

Pressing “Instrument Setup” button will require authorization password.

Enter 8 digit user password, typing correct user password will enter to Instrument setup menu.

Viewing and Changing Instrument Setup parameters

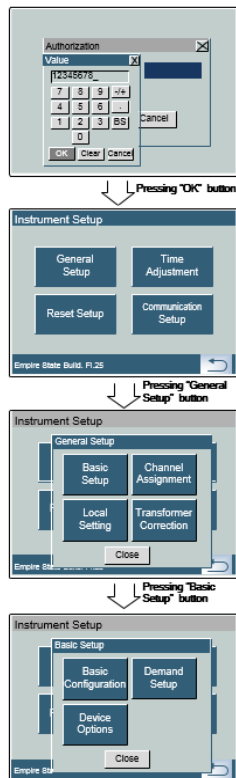

While typing the valid user level password will enter to the Instrument Setup menu.

Press General Setup button to enter main instrument parameters setup menu

Press Basic Setup button to enter main instrument parameters setup menu

General Setup

Basic Setup

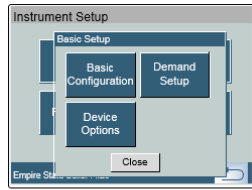

Pressing "Basic Configuration" button

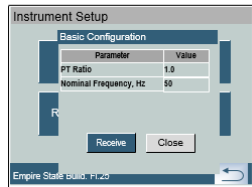

Pressing "PT Ratio Value" field

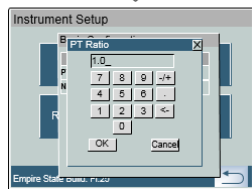

The BFM II Basic Setup parameters menu consists of defining main electrical parameters according to the installation.

Pressing the Basic Configuration button allows you to see the electrical parameters basic setup

Parameters in light grey background are read only and cannot be changed from the front panel. Use PAS™, SATEC software configuration tool, to setup these parameters.

The following table lists available setup options

Parameter	Options	Default	Description
PT Ratio	1.0-6500.0	1.0	The phase potential transformer's primary to secondary ratio
Nominal frequency	50, 60 Hz	60 Hz	The nominal power frequency

Demand Setup

The following table lists available setup options - can be setup using PAS SW tools only, see chapter 4 [General Meter Setup](#)

Parameter	Options	Default	Description
Block power demand period	1, 2, 3, 5, 10, 15, 20, 30, 60 min	30	The length of the demand period for power demand calculations
The number of blocks in the sliding window	1-15	1	The number of blocks to be averaged for sliding window demands
Volt demand period	0-9000 sec	900	The length of the demand period for volt demand calculations
Ampere demand period	0-9000 sec	900	The length of the demand period for ampere demand calculations

Device Options

The following table lists available options - can be setup using PAS SW tools only, see chapter 4 [General Meter Setup](#)

Parameter	Options	Default	Description
Power calculation mode	Reactive, NonActive (non-active power)	Reactive	The method used for calculating reactive and apparent powers
Energy roll value	100000.0-100000000.0 kWh	10000000 0.0	The value at which energy counters roll over to zero
Energy test mode	OFF, Wh, varh	OFF	Setting this option puts the device into the energy test mode
Wh LED pulse rate, Wh/pulse	0.01-100.00	5.40Wh/pulse (one equivalent disk revolution)	LED pulse constant - the amount of accumulated energy giving one pulse via "Wh" LED
Energy LED source	1-60, None	1	Selects a submeter as a LED pulsing source

Parameter	Options	Default	Description
Tariff Control	Calendar Communication Tariff inputs D1...D8	Calendar	Defines the tariff switching method (see "Tariff Control" below).

Tariff Control

The BFM II provides an unique tariff program for all device submeters, there are three options for switching tariff rates, can be setup using PAS SW tools only, see chapter 4 [General Meter Setup](#):

- automatic via a programmable TOU calendar schedule (see [Configuring the Daily Tariff Schedule](#) for information on configuring tariff change points)
- external via communications by writing a tariff number to the meter tariff register (see the BFM II Modbus Reference Guide for information on the active tariff register location)
- external via digital inputs by providing a tariff code on the meter tariff inputs

If a digital input option is selected, you can use 1 to 3 consequent digital inputs as tariff inputs. The following table shows the number of inputs required depending on the maximum number of used tariff rates.

Number of tariffs	Number of tariffs inputs
2	1
3	2
4	2
5	3
6	3
7	3
8	3

The following table shows code combinations that should be provided on the tariff inputs to indicate an active tariff rate.

Tariff Rate Number	Tariff Code		
	Tariff Input 1	Tariff Input 2	Tariff Input 3
1	open	open	open
2	closed	open	open
3	open	closed	open
4	closed	closed	open
5	open	open	closed
6	closed	open	closed
7	open	closed	closed
8	closed	closed	closed

Submeter Channel Assignments

The Submeter Channels Assignments setup menu allows to setup submeter name only.

To setup the CT primary value of the desired submeter according to the SATEC CT - HACS/RS5 rating, follow chapter [General Meter Setup, Channel assignment](#)

Transformer Correction

To setup the Transformer Correction linearity and angles values of the desired submeter, follow chapter [General Meter Setup, Transformer Correction](#)

The following table lists available options.

Label	Parameter	Options	Default	Description
Ratio V1-V3	V1-V3 voltage transformer ratio correction factor	0.700 to 1.300	1.000	The ratio of the true transformer ratio to the marked ratio.
Angle V1-V3	V1-V3 transformer phase angle error, minutes	-600 to 600	0	The phase displacement, in minutes, between the primary and secondary values. The phase angle of a voltage transformer is positive when the secondary value leads the primary value.
Ratio I1-I54	I1-I54 current transformer ratio correction factor	0.700 to 1.300	1.000	The ratio of the true transformer ratio to the marked ratio.
Angle I1-I54	I1-I54 transformer phase angle error, minutes	-600 to 600	0	The phase displacement, in minutes, between the primary and secondary values. The phase angle of a current transformer is positive when the secondary value leads the primary value.

Local Setting

To setup the Transformer Correction linearity and angles values of the desired submeter, follow chapter 4 [General Meter Setup, Local Setting](#)

The following table lists available options.

Parameter	Options	Default	Description
Country code	Default, or country name	Default	Defines a currency and calendar settings. The default setting stands for the U.S.A.
Daylight saving time (DST) option	Disabled, Enabled	Disabled	When DST is disabled, the RTC will operate in standard time only. When enabled, the BFM II will automatically update the time at 2:00 AM at the pre-defined DST switch dates.
DST start month	January-December	April	The date when Daylight Saving Time begins. The DST switch point is specified by the month, week of the month and weekday. By default, DST starts at 2:00 AM on the first Sunday in April of each year.
DST start week of the month	First, Second, Third, Fourth, Last	First	
DST start day of the week	Sunday-Saturday	Sunday	
DST start Hour	1.00-24.00	2	
DST end month	January-December	October	The date when Daylight Saving Time ends. The DST switch point is specified by the month,
DST end week of the month	First, Second, Third, Fourth, Last	Last	

Parameter	Options	Default	Description
DST end day of the week	Sunday-Saturday	Sunday	week of the month and weekday. By default, DST ends at 2:00 AM on the last Sunday in October of each year.
DST end Hour	1.00-24.00	2	

Time Adjustment Setting

Pressing the Time Adjustment button will allow you to adjust internal real time clock and date.

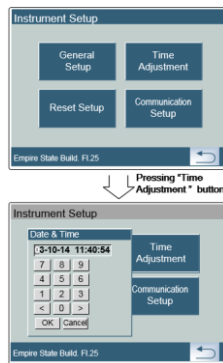

Pressing the Time Adjustment button will open numerical keyboard to change the date and time.

Type the desired date and time, then press OK to enter the value into the instrument

Communication Setup

This menu allows you to setup serial communication parameters and protocol address for COM1-3 and network parameters for ETHERNET port.

Serial Communication Setup

These two menus allow you to configure parameters for communication ports COM1 and COM2. The BFM II automatically detects a replaceable communication module and will not allow you to change the baud rate and data format for the Dial-up modem, and for the Ethernet and RF modules.

To enter the menu, select the COM1 or COM2 entry from the main menu, and then press the ENTER button. For instructions on navigating in the menu, see [Viewing and Changing Setup Items](#).

The following table lists available port options.

Label	Parameter	Options	Default	Description
Protocol	Communications protocol	MODBUS RTU, DNP3	MODBUS RTU	The communications protocol for the port
Interface	Port interface	RS485, RS232, Modem, GSM/GPRS, RF	COM1 COM2 COM3 COM4	Not changeable; automatically detected by the device
Address	Device address	MODBUS: 1-247 DNP3: 0-65532	1	Device's base network address (see Submeter Addressing)
Baud rate	Baud rate	2.4-115.2 kbps	19.2 kbps	The port baud rate
Data/Prt	Data format and parity	7E, 8N, 8E	8N	7E data format should not be used with the Modbus RTU protocol
Send Delay	Transmission delay	0-1000 ms	5 ms	The minimum time after the last request character is received to start the transmission.

Label	Parameter	Options	Default	Description
Chr.Tmout	Inter-character timeout	0-1000 ms	4 ms	The maximum time the line is allowed to idle before closing a connection in the Modbus RTU protocol

Note

When using the expertpower™ client (see [Configuring eXpertPower Client](#)), submeter address 99 on the Ethernet port COM2 is reserved for the BFM II router and must not fall inside the range of the submeter addresses for this port.

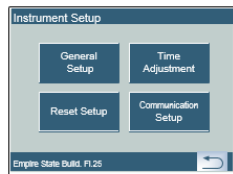

Pressing the Communication Setup button will open a new setup menu showing all possible communication ports than can be setup.

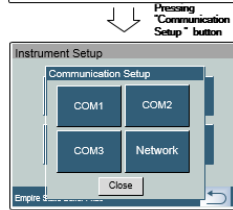

Pressing COM1 button will show the current COM1 setup parameters.

Parameters in light grey background are read only and cannot be changed from the front panel. Use PASTM, SATEC software configuration tool, to setup these parameters.

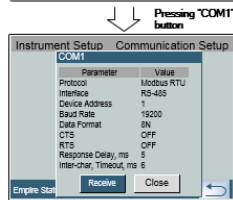

Press Device Address Value field to change the protocol device address.

Type the desired device address using the numeric keyboard and press OK to store it in the instrument.

Repeat these steps for COM2 & 3

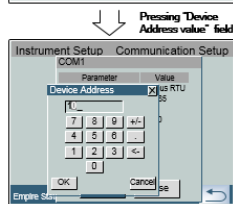

Network Communication Setup

This menu allows you to configure the Ethernet port for direct communications through the LAN or the Internet.

To enter the menu, select the Net entry from the main menu, and then press the ENTER button. For instructions on navigating in the menu, see [Viewing and Changing Setup Items](#).

The following table lists available Ethernet options.

Label	Default	Description
IP Address	192.168.0.203	Device IP address
Subnet Mask	255.255.255.0	Subnet mask
Def.Gateway	192.168.0.1	Default gateway

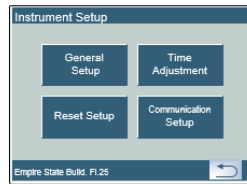

Pressing "Communication Setup" button

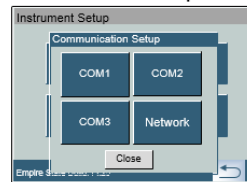

Pressing "NETWORK" button

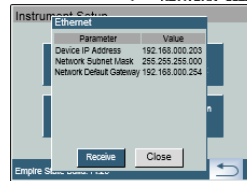

Pressing the "Device IP Address" value field

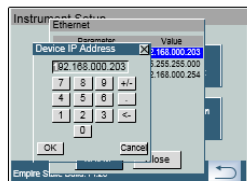

To enter the menu, select the NETWORK button from the Communication Setup menu.

Parameters in light grey background are read only and cannot be changed from the front panel. Use PASTM, SATEC software configuration tool, to setup these parameters.

Press IP Address Value field to change the device IP address network.

Type the desired IP address using the numeric keyboard and press OK to store it in the instrument.

Reset Setup

This menu allows you to reset maximum demands, data log, counters, TOU summary maximum demand and event logs.

To enter the menu, select the Reset entry from the main menu, and then press the ENTER button.

Reset Device Maximum Demands

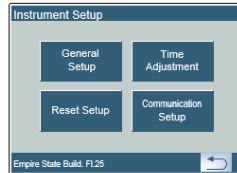

Pressing "Reset Setup" button

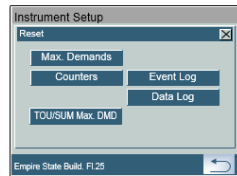

Pressing "Max. Demands" button

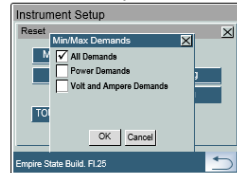

To reset the Maximum Demands Log press "Max. Demands" button

Select the desired demands parameters to be cleared.

Pressing "OK" button will clear the selected maximum demands parameter, and will return to RESET menu.

rs

To reset the Device Counters press "Counters" button

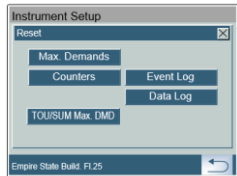

Pressing "Counters" button

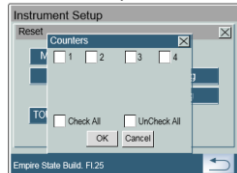

Select the one or more counters to be cleared

Pressing "OK" button will clear all selected counters, and will return to RESET menu.

Reset Device Event Log

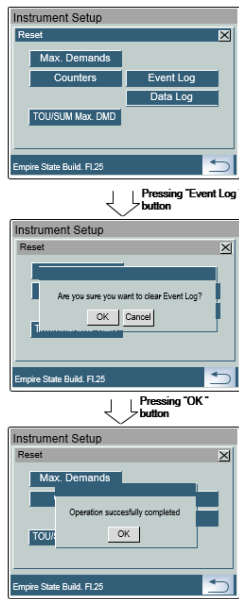

To reset the Device Event Log press “Dev. Event Log” button

Pressing “OK” button will clear the Event Log, and will return confirmation box.

Pressing “OK” will return to RESET menu.

Reset Device Data Log

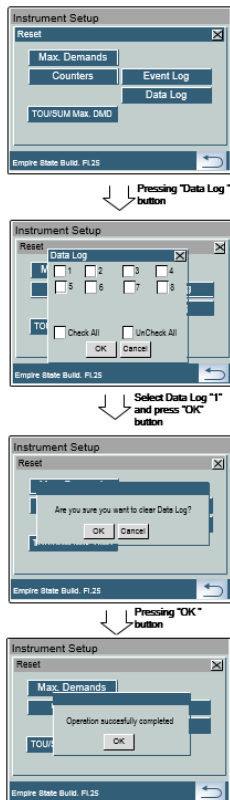

To reset the Device Data Log press “Data Log” button

Select desired data log and press “OK” button to clear the Data Log, and will return confirmation box.

Pressing “OK” will return to RESET menu.

Reset Device Billing/TOU Maximum Demands

Not available.

Display Info and Setup

Display Info

This menu allows you to configure options for the BFM II display and to show Display factory info.

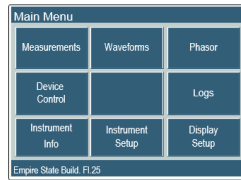

Pressing "Display Setup" button

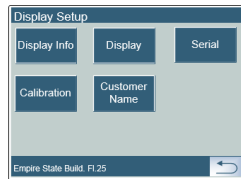

To enter the menu, press the Display Setup button from the main menu.

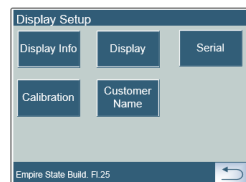

Pressing "Display Info" button

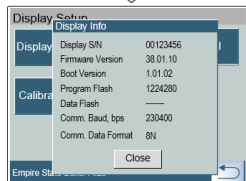

The Display Info menu allows you to see the display factory info

Press the Display Info button to move to the display factory info screen.

Display Setup

The Display Setup menu allows you to configure the display language, sleep mode and brightness.

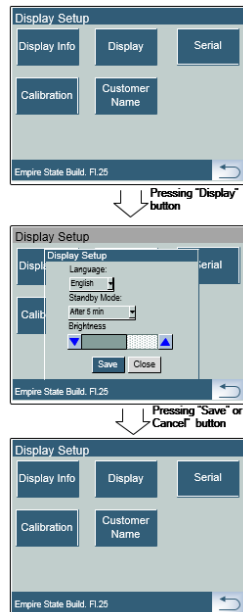

Press the Display button to setup the main display parameters.

By pressing the “Language” arrow will allow you to select the display language

By pressing the “Standby Mode” arrow will allow you to determine the display standby mode timeout

Use up arrow to increase or down arrow to decrease the display brightness

Pressing “Save” button will setup the general setup and will return to Display Setup menu

Pressing “Close” button will return to Display Setup menu without saving the setup parameters.

Customer Name

The Customer Name menu allows you to determine the device Customer Name to appear on the BFM II GDM menu bar screen (bottom bar

Pressing Customer Name button will provide an alpha numeric “qwerty” keyboard to enter the Customer Name.

Chapter 4 Using PAS™ Application Software

The support PAS software is a configuration and data acquisition tool that allows you to configure all of the BFM II features, monitor your meter on-line, retrieve recorded files and view log files. PAS can communicate with your meter via any communication interface installed in your meter, including the serial ports, and the Ethernet and wireless CELLULAR communications.

This chapter gives information on how to install and run PAS on your computer, and how to prepare information for your meter using PAS.

Software Installation

Installing PAS™ Software

You need PAS V1.4.13 or higher to work with the BFM II.

To install PAS on your PC:

1. Insert the installation CD supplied with your BFM II into CD drive.
2. Open My Computer on your Desktop.
3. Click on your CD drive icon, select the PAS directory, and then double click on Setup (shown as an Application type file).
4. Follow InstallShield® Wizard instructions on the screen.



PAS

PAS is installed by default to the C:\Program Files\Pas folder. If your user account rights do not allow writing to the C:\Program Files\ folder, change the PAS default installation folder to another folder to avoid possible ODBC security problems when running PAS.

To run PAS, you need Windows 98, Windows NT, Windows 2000, Windows XP, Windows 7 and Windows 8 installed on your computer. PAS will not run properly on Windows 95.

When installation is complete, the PAS icon appears on your Desktop. Double click on the PAS icon to run PAS.

For general information on how to work with PAS, see the "PAS Getting Started" guide supplied on the installation CD.

Installing the USB driver

To take an advantage of the USB communications, install the BFM II USB driver on your PC.

Connect the BFM II to your PC's USB port using the supplied USB cable. When the BFM II is powered up, Windows automatically detects the meter and launches the hardware installation wizard. The following example demonstrates an installation of the USB driver on Windows XP.

1. The "Found New Hardware Wizard" dialog box is displayed as follows.

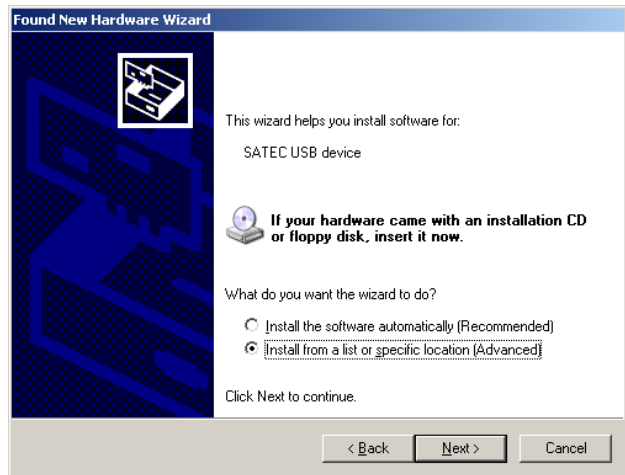

2. Select “Install from a list or specific location” and click “Next”.

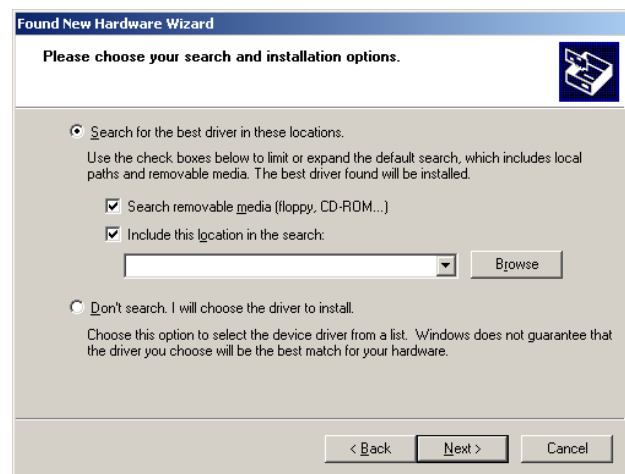

3. Click “Browse”.



4. Point to the “USB” folder located in the PAS installation directory and click “OK”

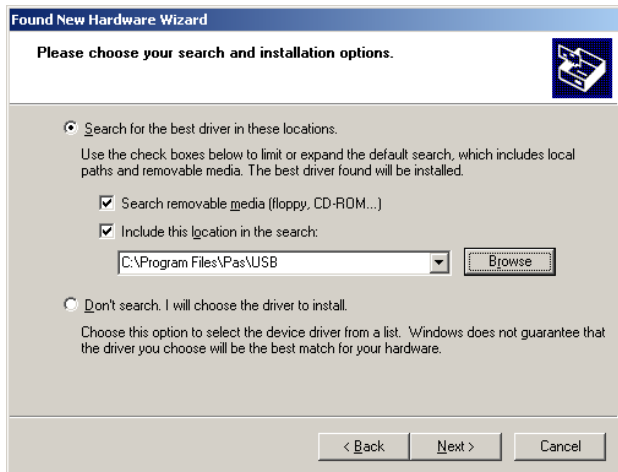

5. Click "Next".



6. Click "Finish" to complete installation.

The next time you power up the BFM II or connect it to your PC with the USB cable, Windows automatically launches the driver for your meter.

Using PAS

The supplemental PAS software can be used for configuring the BFM II through communication ports, for retrieving real-time and energy profile data, and for remote upgrading device firmware.

Creating a new site for your Meter / Submeters

Each submeter in your device is accessed using a different communication address (see [Submeter Addressing](#)).

To communicate with your submeters, create a separate site database for each submeter. During configuration, store all setups to the site database so that PAS will recognize your device's properties regardless of whether the device is online or offline.

To create a new database for a submeter:

1. Select Configuration from the Tools menu, and then click the Sites button on the right-hand-side.

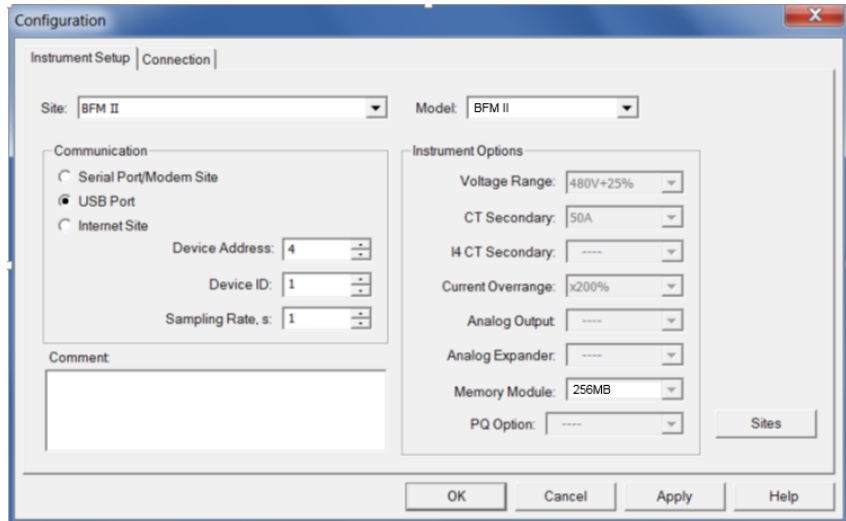

2. From the “Look in” box, select the directory where a new database will be stored. By default, it will be the “Sites” directory. Type a site name for the submeter in the “File name” box, click “New”, and then click OK.
3. On the Instrument Setup tab, select BFM II in the “Model” box. PAS automatically selects the appropriate instrument options for the submeter.
4. If you wish to add any comments for the submeter, type them into the “Comments” box.

Setting up Communications

You can communicate with your devices via a PC RS-232 serial port, a PC USB port, through the Internet, via either a local Ethernet, or a wireless CELLULAR (GPRS-2G or 3G) Dial-Up connection.

To configure your communications with the BFM II:

1. Select Configuration from the Tools menu. Under the Communication group on the Instrument Setup tab, select the type of a connection for your device.
2. Set the device communication address you assigned to the BFM II. When communicating via the Ethernet or a CELLULAR modem, the BFM II responds to any address you select.
3. In the "Sampling Rate" box, select a rate at which PAS updates data on the screen when polling the device via the PAS Data Monitor.

The communication protocol and port settings in PAS must match the settings made in your device.

4. In the Address box, select an appropriate submeter address.
5. In the Sampling Rate box, select a rate at which PAS updates data on your screen when you continuously poll the device via the PAS Data Monitor.

Communicating through a Serial Port

Select Serial Port/Modem Site on the Configuration tab, and then click on the Connection tab to configure your serial port settings.

Configuring a Serial Port

1. On the Connection tab, select a COM port from the Device box, and then click Configure.

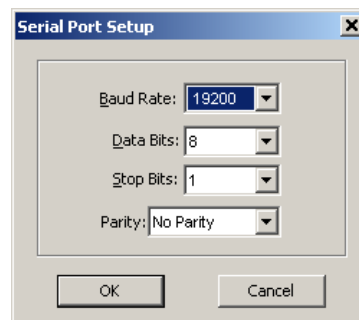

2. Specify the baud rate and data format for the port. Choose the same baud rate and data format as you have set in the BFM II, and then click OK. The default settings for the local RS-232 and RS-422/485 serial ports are 19200 baud, 8 bits with no parity.

Selecting the Communications Protocol

1. On the Connection tab, click Protocol.

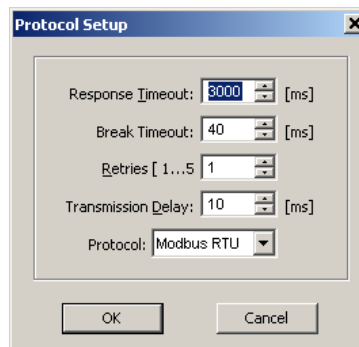

2. In the Protocol box, select the same communications protocol as you have in your BFM II. The default protocol setting in the BFM II for all ports is Modbus RTU.
3. The remaining settings in this dialog do not normally need to be changed.
4. In the “Response Time-out” box, define the maximum time that PAS should wait for the meter response before announcing a failure. When communicating through a CELLULAR modem, this time may require some adjustment.
5. The “Break Time-out” box defines the maximum idle time that PAS waits after receiving the last message character to close a connection. This setting is important only when PAS is running the Modbus RTU or DNP3 protocols. It does not affect Modbus ASCII communications. The default value of 10 ms is usually sufficient for reliable communications, but the load on your PC can affect it. If there are many applications running on your PC, PAS might be prevented from responding to received characters fast enough, so it may close the communication while the device is still transmitting a message. If you frequently receive the message “Communication failed”, this could mean that “Break Time-out” should be increased. This time is added to the message transfer time, however, increasing it excessively slows down communications.
6. The “Retries” box defines the number of attempts that PAS uses to receive a response from the device in the event the communication fails before announcing a communication failure.

For more information on configuring the protocol parameters, refer to the PAS Getting Started guide.

Communicating through the Internet

If you are communicating via the Ethernet, define the IP address of your BFM II on the network.

1. On the Instrument Setup tab, select Internet Site.
2. Click on the Connection tab.

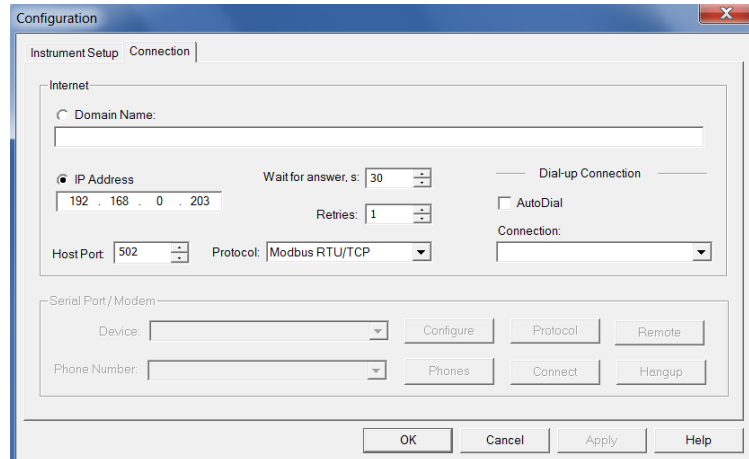

3. Click IP address and type in the IP address of your BFM II. The factory-set IP address is 192.168.0.203.
4. In the Protocol box, select Modbus RTU. The default host port 502 is set automatically as you select the protocol.
5. In the Wait for answer box, adjust the time that PAS will wait for a connection before announcing an error and the number of retries PAS will use to receive a response from the device if communications fail.

Communicating through a CELLULAR (2G/3G) module

Configuring a Dial-up CELLULAR (GPRS-2G or 3G) Connection

To communicate through a CELLULAR modem:

1. On the Instrument Setup tab, select Internet Site.
2. Click on the Connection tab.

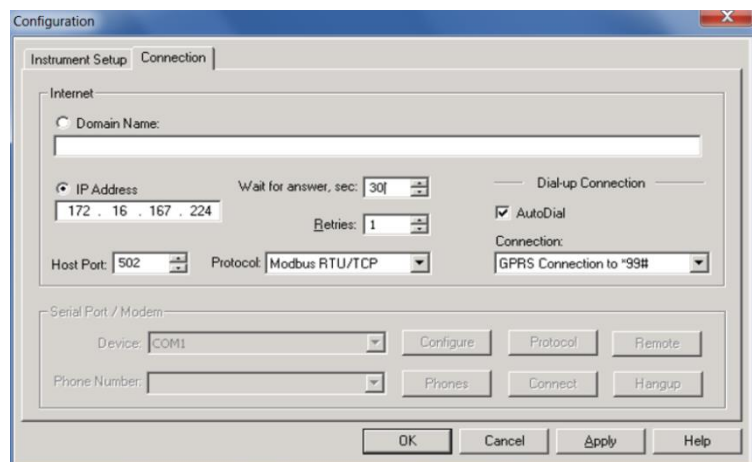

3. Click on the "IP address" and type in the IP address your meter got from the CELLULAR provider when registering on the CELLULAR network. You can find the meter CELLULAR IP address on the GPRS page in the Device Info display (see Device Info Display in Chapter 3) or via the Dial-Up Networking setup dialog in PAS (see Modem/GPRS IP Address in Setting-Up Dial-Up GPRS Network in Chapter 4)

4. In the “Protocol” box, select the communications protocol for the BFM II GPRS TCP port. The host port is set automatically as you select the protocol. Select “Modbus RTU/TCP” for Modbus/TCP, or “DNP3” for DNP3/TCP.
5. In the “Wait for answer” box, adjust the time that PAS should wait for a connection before announcing an error and the number of re-tries that PAS should use to receive a response from the device if communications fail.
6. In the “Connection” box, select the Dial-up connection you created for the BFM II. See Dial-Up Networking for information on how to create a Dial-up connection in Windows.
7. Check the AutoDial box, if you wish PAS to automatically connect to your meter every time you access it from PAS; otherwise you must manually dial your connection.

Communicating through a USB

On the Instrument Setup tab, click USB Port, and then click OK.

Preparing Setups

PAS allows you to prepare setup data for your BFM II off-line without the need to have it connected to your PC.

To prepare a setup for your meter:

1. Select the device site from the list box on the PAS toolbar.
2. Select the desired setup group from the Meter Setup menu. Click on the tab with the setup you want to create or modify.
3. Fill in the boxes with the desired configuration data for your meter.
4. Click the “Save as...” button to store the data to the meter site database.
5. Click OK.

NOTE

Always set up and store the Basic Setup data to the site database first. PAS uses this data as a reference when arranging other meter setups.

To save your setup to another site database:

1. Click the “Save as...” button.
2. Select the target database from the file pane.
3. Click OK.

You can also reuse a setup from another site by copying it to your present site database.

To copy a setup from another site's database:

1. Click Open.
2. Select the desired source site database.
3. Click OK. The opened setup is copied to your dialog window.
4. Click the “Save as...” button.
5. Select the target database from the file pane.
6. Click OK.

To copy all setups from one site database to another site's database:

1. In the list box on the toolbar, select a source device site from which you wish to copy setups.
2. Select “Copy to...” from the Meter Setup menu.

Downloading Setups

You can update each setup in your BFM II one at a time or download all setups together from the site database.

To update a particular setup, check the On-line button on the PAS toolbar, select a submeter site from the list box on the toolbar, and then select the desired setup group from the Meter Setup menu. Click on the tab of the setup you want to download to the device, and then click Send.

To download all setups at once, check the On-line button on the toolbar, select the submeter site from the list box on the toolbar, and then select Download Setups from the Meter Setup menu.

Device setup settings, excluding the alarm setpoints and data log setup, are shared across all submeters. Though you can download them to the device using any submeter address, your changes affect all submeters in the device.

The alarm setpoints and data log setup must be downloaded separately to every submeter using its local address. If you wish to download the same settings to all submeters in your device, prepare the alarm setpoints and/or data log setup for one

of the submeters and store them to its site database, select the submeter site from the list box on the toolbar, and then click Download to all Submeters on the Meter Setup menu.

Uploading Setups

To upload the setups from the submeter to the site database, check the On-line button on the PAS toolbar, select the submeter site from the list box on the toolbar, and then select Upload Setups from the Meter Setup menu.

Authorization

If communications with your device is secured, you are prompted for the password when you send new setup data to the BFM II.

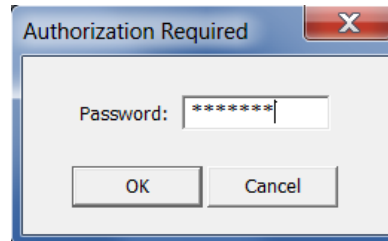

Enter the password and click OK. If your authorization was successful, you are not prompted for the password again until you close the dialog window.

Changing Port Settings

This section describes how to configure communication ports in the BFM II through PAS.

The communication settings affect all submeters in your device.

Communication Ports Setup

To enter the setup dialog, select the site from the list box on the PAS toolbar, select Communications Setup from the Meter Setup menu, and then click on the Serial Ports Setup tab. In the Port box, select the desired device port.

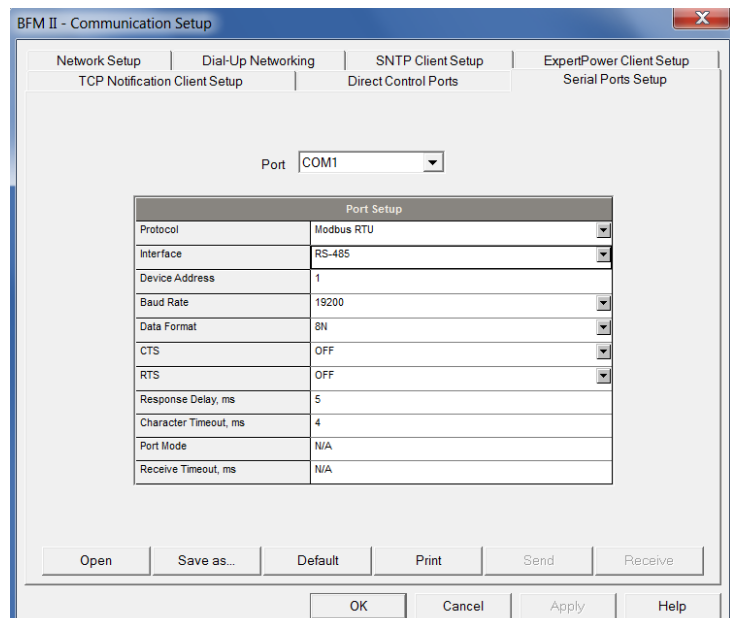

To change the port settings, select desired port parameters, and then click Send. For the available communication options, see [Communication Ports](#) in Chapter 3.

Note

When using the expertpower™ client (see Configuring expertpower Client), submeter address 99 on the Ethernet port is reserved for the BFM II router and must not fall inside the range of the submeter addresses for this port.

Setting Up the Local Network

To enter the setup dialog, select the device site from the list box on the PAS toolbar, select Communications Setup from the Meter Setup menu, and then click the Network Setup tab.

The screenshot shows the 'BFM II - Communication Setup' dialog box with the 'Network Setup' tab selected. The dialog is divided into several sections:

- Current Network Settings:**

IP Address	0 . 0 . 0 . 0
Subnet Mask	0 . 0 . 0 . 0
Default Gateway	0 . 0 . 0 . 0
MAC Address	000000000000
- Network Setup:**

Device IP Address	192 . 168 . 0 . 203
Network Subnet Mask	255 . 255 . 255 . 0
Network Default Gateway	192 . 168 . 0 . 1
Use DHCP	NO
Secondary TCP Port	----
Primary DNS IP Address	0 . 0 . 0 . 0
Secondary DNS IP Address	0 . 0 . 0 . 0
Connection Idle Timeout, s	120
Device Address	1

Buttons at the bottom include Open, Save as..., Default, Print, Send, Receive, OK, Cancel, Apply, and Help.

To change the Ethernet settings in your device, select desired parameters, and then click Send. For the available options, see [Local Network Settings](#) in Chapter 3.

Setting Up Cellular - Public Network

To enter the setup dialog, select the device site from the list box on the PAS toolbar, select Communications Setup from the Meter Setup menu, and then click the Dial-Up Networking tab.

The screenshot shows the 'BFM II - Communication Setup' dialog box with the 'Dial-Up Networking' tab selected. The dialog is divided into several sections:

- Current Network Settings:**

Local IP Address	0 . 0 . 0 . 0
------------------	---------------
- Connection Options:**

Local IP Address	192 . 168 . 10 . 203
Network Subnet Mask	255 . 255 . 0 . 0
Remote IP Gateway Address	192 . 168 . 10 . 204
Redial Attempts	3
Connection Timeout, s	30
Time Between Redial Attempts, s	10
Idle Time Before Hanging Up, s	0
Rings Before Answer	0
Modem Initialization	AT&F0&D1&C1
Auto-reset Period, hours (0=never)	0
- ISP Account:**

Phone Number	*99#
Login Name	
Login Password	
GPRS Access Point Name (APN)	publicip.net.ii

Buttons at the bottom include Open, Save as..., Default, Print, Send, Receive, OK, Cancel, Apply, and Help.

The following table lists available connection options.

Parameter	Options	Default	Description
Connection Options			
IP Address		168.10.203	IP address on the dial-in modem PPP network. Not used in a GPRS network.
Network Subnet Mask		255.0.0	PPP/GPRS network subnet mask
Network Default Gateway		168.10.204	PPP network default gateway. Not used in a GPRS network.
Redial Attempts	00, 0 = forever		number of dial attempts to connect to a remote modem if a connection was unsuccessful.
Connection Timeout	99 sec		modem cancels a call if not connected within the connection timeout time.
Time Between Redial Attempts	99 sec		the delay between redials.
Idle Time Before Hanging Up	99 sec 0 = never		modem disconnects a call if idle for more than the specified idle time.
Rings before Answer	0 = never		number of rings before the modem answers an incoming call from a remote modem. Not used in a GPRS network.
Modem Initialization		F&D1&C1	default modem initialization string. Do not change.
ISP Account			
Phone Number		*99#	telephone number of the ISP provider. The default number provides a connection to the GPRS network for your BFM II GSM/GPRS modem.
Login Name			login name for logging onto the Internet (if required).
Login Password			login password for logging onto the Internet (if required).
GPRS Access Point Name (APN)		net	mobile network APN name (consult with your network operator)

Note

Do not change the default modem connection options. Consult with your GPRS network operator if the network subnet mask needs to be extended.

Setting up SNMP Client

(Future)

Configuring expertpower Client

The BFM II has an embedded expertpower™ client that provides communications with the eXpertPower™ server - the SATEC proprietary Internet services. Connections to the eXpertPower™ server are handled on a periodic basis.

To enter the Setup dialog, select the site from the list box on the PAS toolbar, select Communication Setup from the Meter Setup menu, and then click the expertpower™ Client Setup tab.

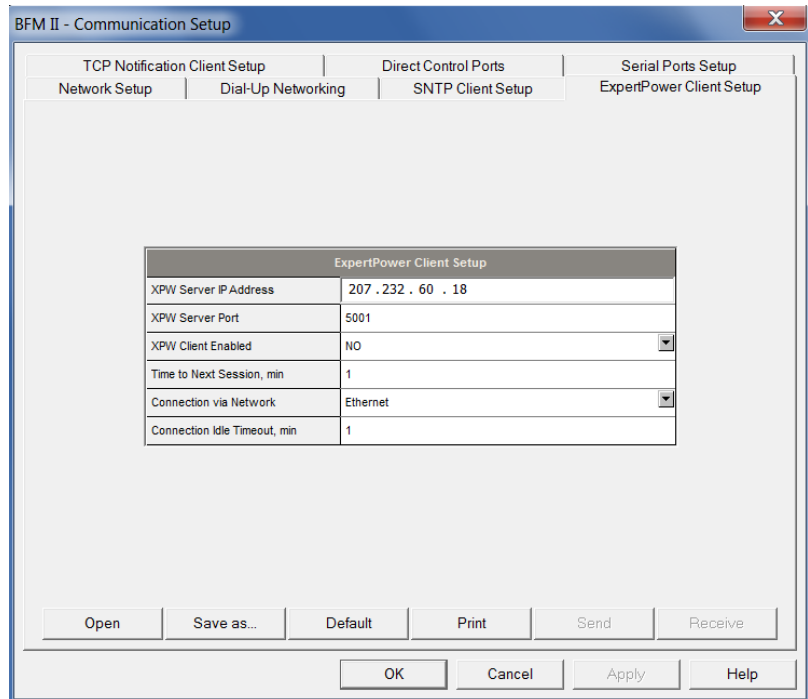

The following table lists available options. Refer to your eXpertPower service provider for the correct eXpertPower settings.

Parameter	Options	Default	Description
XPW Server IP Address		207.232.60.18	The IP address of the eXpertPower server
XPW Server Port	0-65535	5001	The TCP service port of the eXpertPower server
XPW Client Enabled	NO, YES	NO	Enables operations of the eXpertPower client
Time to Next Session, min	1-99999		The time remaining to the next connection session
Connection via Network	Ethernet/GPRS modem	Ethernet	cts the network for connecting to the eXpertPower server
Connection Idle Timeout, min	1-120	1	eXpertPower keep alive timeout

NOTES

1. If you do not use the eXpertPower™ service, do not enable the expertpower™ client in your device.
2. Do not change the connection period setting. The eXpertPower server updates it automatically.

General Meter Setup

This section describes how to configure the BFM II for your particular environment and application using PAS.

Basic Meter Setup

Before operating your meter, provide the device with basic information about your electrical network.

To enter the setup dialog, select the device site from the list box on the PAS toolbar, and then select General Setup from the Meter Setup menu.

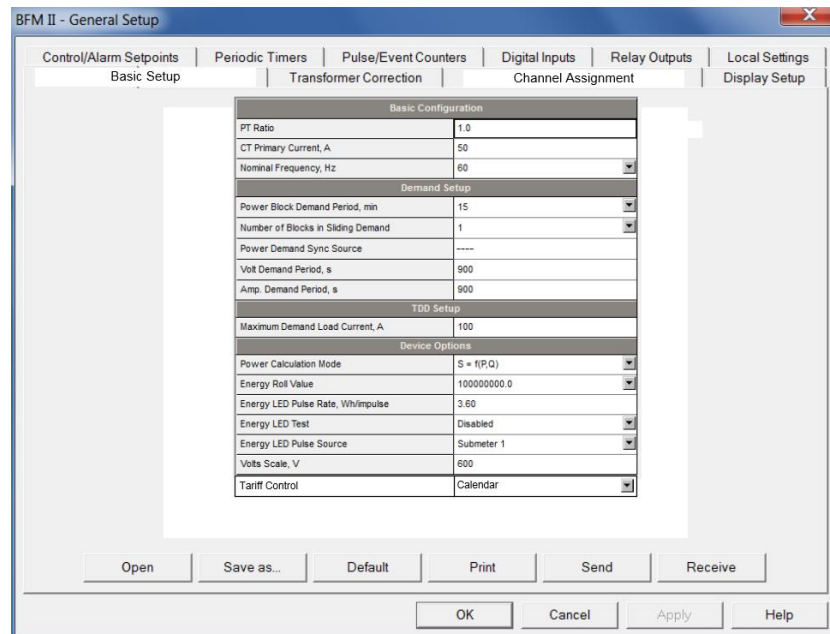

The following table lists available device configuration options.

Parameter	Options	Default	Description
Basic Configuration			
PT Ratio	1.0-6500.0	1.0	The phase potential transformer's primary to secondary ratio
Primary current	1-10000 A	50A ¹	The HACS primary nominal current of the selected submeter; for information only.
Nominal frequency	50, 60 Hz	60Hz	The nominal power frequency
Demand Setup			
Power Block Demand Period, min	1, 2, 3, 5, 10, 15, 20, 30, 60 min	15	The length of the demand period for power demand calculations
The number of blocks in the sliding window	1-15	1	The number of block demand periods to be averaged for sliding window demands
Volt demand period	0-9000 sec	900 sec	The length of the demand period for volt demand calculations
Ampere demand period	0-9000 sec	900 sec	The length of the demand period for ampere demand calculations
Device Options			
Power calculation mode	S=f(P, Q) (using reactive power), Q=f(S, P) (using non-active power)	S=f(P, Q)	The method used for calculating reactive and apparent powers (see "Power Calculation Modes" below)

¹ The default primary current transformer value depends on the Submeter module (MCM, CIM6/18) model whether HACS - 50A default CT primary value either RS5 - 10A default CT primary value.

Parameter	Options	Default	Description
Energy roll value, kWh	100000.0 kWh 1000000.0 kWh 10000000.0 kWh 100000000.0 kWh	100000000.0	The value at which energy counters roll over to zero
Energy LED pulse rate, Wh/pulse	0.01-100.00	5.40 Wh/pulse (one equivalent disk revolution)	LED pulse constant - the amount of accumulated energy (in secondary readings) giving one pulse via "Wh".
Energy LED Test	Disabled, Wh Pulses, varh Pulses	Disabled	The type of accumulated energy giving pulses via "Wh" LED.
Energy LED Pulse source	Submeter 1, Submeter 2, ... Submeter 60	Submeter 1	The submeter uses as source of accumulated energy giving pulses via "Wh" LED.
Volts Scale, V	60-600 V	600 V	The maximum voltage scale allowed, in secondary volts. See Data Scales in Appendix E
Tariff Control	Calendar, DI1-DI8, communication	Calendar	Defines the tariff switching method. See Tariff Control

Power Calculation Modes

The power calculation mode option allows you to change the method for calculating reactive and apparent powers in presence of high harmonics. The options work as follows:

1. When the reactive power calculation mode is selected, active and reactive powers are measured directly and apparent power is calculated as:

$$S = \sqrt{P^2 + Q^2}$$

This mode is recommended for electrical networks with low harmonic distortion, commonly with THD < 5% for volts, and THD < 10% for currents. In networks with high harmonics, the following method is preferable.

2. When the non-active power calculation mode is selected, active power is measured directly, apparent power is taken as product $S = V \times I$, where V and I are the RMS volts and amps, and reactive power (called non-active power) is calculated as:

$$N = \sqrt{S^2 - P^2}$$

Channel Assignments

The Channel Assignments setup allows you to link the device current terminals to submeters so they can monitor them. Additionally, this setup allows you to specify the primary current rating of the current transformers connected to the device terminals. The number of the selected current inputs for a submeter specifies if it will be a single-, two-, or three-phase meter.

Always select your submeters (both metering and totalization) in a sequence without gaps so that your device does not occupy unnecessary network addresses.

To enter the setup dialog, select the device site from the list box on the PAS toolbar, select General Setup from the Meter Setup menu, and then click on the Channel Assignments tab.

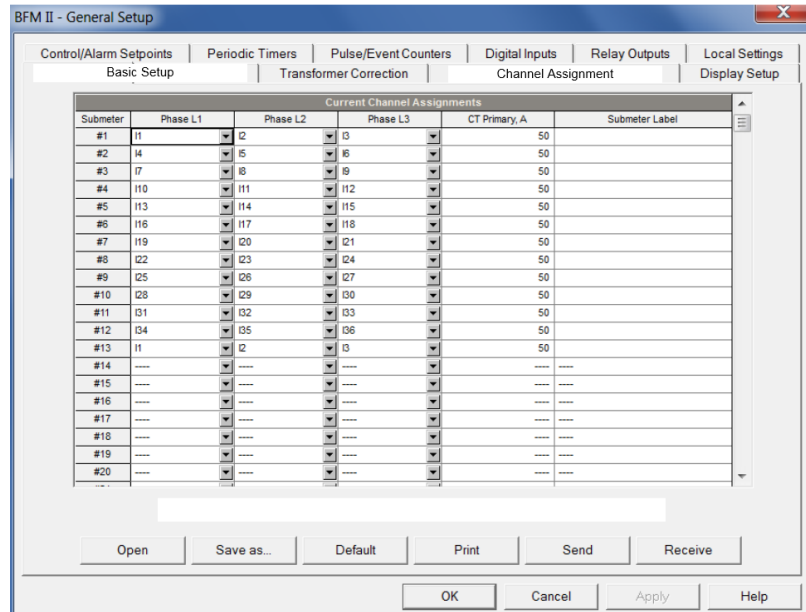

The following table lists available options.

Label	Parameter	Options	Default	Description
Submeter	Submeter number	#1- #54		The submeter index
Phase L1	Phase current input terminal number	I1-I54,	See note ¹	Links a current input terminal to the corresponding submeter's phase voltage input V1, V2 or V3
Phase L2		None		
Phase L3				
CT Primary, A	HACS primary current ²	1-10000 A	50 A or 10A	Specifies the primary rating of the submeter current transformers

Current transformer CT primary setting note:

- If using HACS 100A - CT primary is set to 50A
- If using HACS 400A - CT primary is set to 200A
- If using RS5 - CT primary is set to first CT primary current rating multiplied by 2, for instance if using first CT 1000A/5A, CT primary is set to 2000A

¹ The device is pre-configured for eighteen three-phase submeters as shown in the picture.

² For HACS module models, specify the HACS ratings assuming a $\times 200\%$ device inputs over range. The device inputs are preset for 100A current transformers with a 50A primary nominal rating.

For RS5 module models, specify the HACS ratings assuming a $\times 200\%$ device inputs over range. The device inputs are preset for 20A current transformers with a 5A primary nominal rating.

Transformer Correction

Transformer correction allows you to compensate ratio and phase angle inaccuracies of the user voltage transformers and SATEC current sensors (HACS) instrument.

If you use standard current transformers listed in the last table column, select a transformer type to preset the transformer ratio correction factor and phase angle error to their typical values.

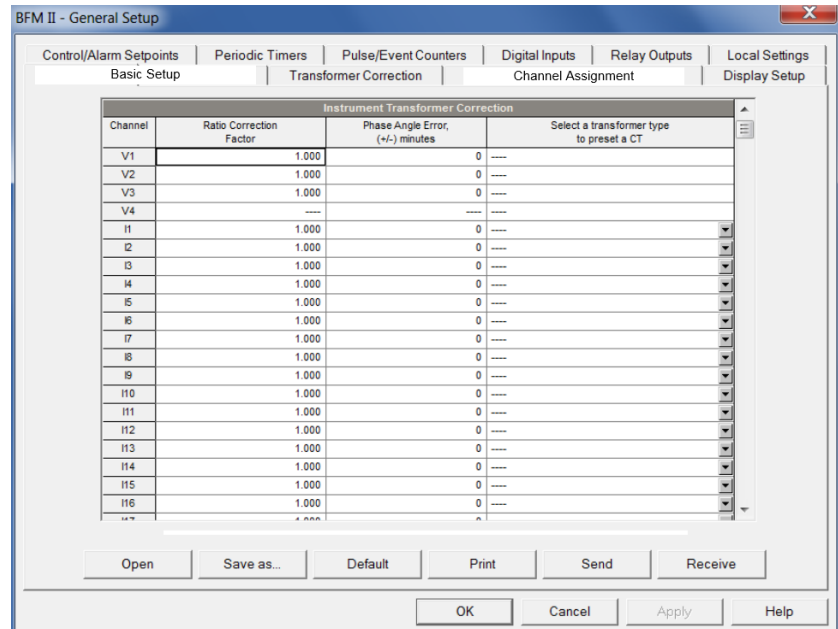

The following table lists available options.

Parameter	Options	Default	Description
Ratio Correction Factor	0.700 to 1.300	1.000	The ratio of the true transformer ratio to the marked ratio.
Phase Angle Error, minutes	-600 to 600	0	The phase displacement, in minutes, between the primary and secondary values. The phase angle of a transformer is positive when the secondary value leads the primary value.

Local Settings

The Local Settings setup allows you to specify your time zone and daylight saving time options.

To configure the time zone options for your device, select the device site from the list box on the PAS toolbar, select General Setup from the Meter Setup menu, and then click on the Local Settings tab.

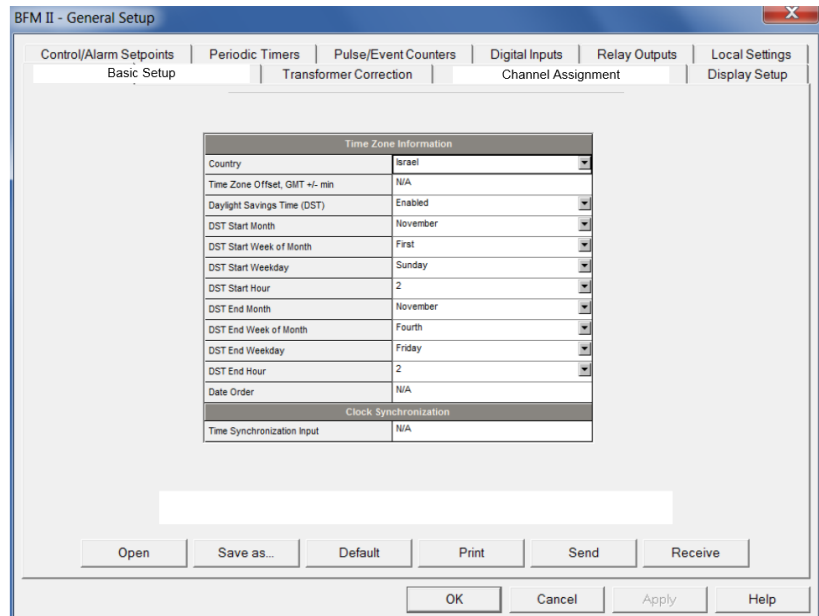

The available options are described in the following table:

Parameter	Options	Default	Description
Country code	Default, or country name	Default	Defines a currency and calendar settings. The default setting stands for the U.S.A.
Daylight saving time option	Disabled Enabled	Disabled	When DST is disabled, the RTC will operate in standard time only. When enabled, the device will automatically update the time at 2:00 AM at the pre-defined DST switch dates.
DST start month DST start week DST start weekday	Month-week-weekday Week = 1 st , 2 nd , 3 rd , 4 th or Last (last week of the month)	First Sunday in April	The date when Daylight Saving Time begins. The DST switch point is specified by the month, week of the month and weekday. By default, DST starts at 2:00 AM on the first Sunday in April of each year.
DST end month DST end week DST end weekday	Month-week-weekday Week = 1 st , 2 nd , 3 rd , 4 th or Last (last week of the month)	Last Sunday in October	The date when Daylight Saving Time ends. The DST switch point is specified by the month, week of the month and weekday. By default, DST ends at 2:00 AM on the last Sunday in October of each year.

When the daylight saving time is enabled, the BFM II automatically adjusts the device clock at 02.00 AM when daylight saving time begins/ends. The default daylight saving time change points are set for the U.S.A.

If the daylight saving time option is disabled, you need to manually adjust the device clock for daylight saving time.

Using Digital Inputs

The BFM II supports up to four expansion Digital Input (DI) modules with a total of 72 digital inputs (DI1 to DI72). I/O numbers are automatically assigned to the inputs in the order of connection when the device is powered up. For example, if two DI modules are connected to the device, the digital inputs DI1-DI18 belong to the first module, and DI19-DI36 - to the following module. If you insert an I/O module into another slot position and do not change its order, then all digital inputs on the module retain their I/O numbers.

To configure the digital inputs in your device, select the device site from the list box on the PAS toolbar, select General Setup from the Meter Setup menu, and then click on the Digital Inputs tab. The digital inputs that are not present in your device are designated as not available.

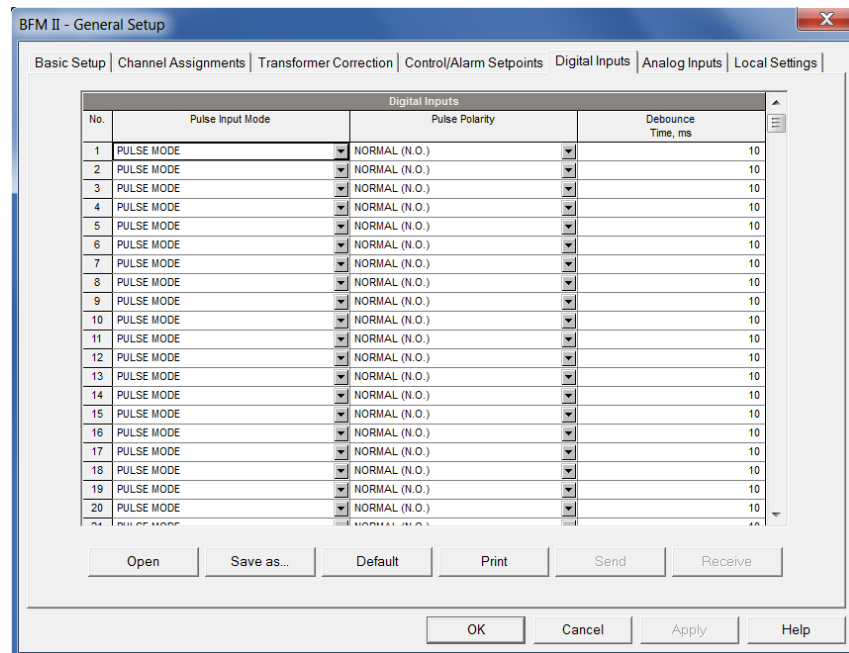

The available options are described in the following table:

Option	Range	Default	Description
Input Polarity	NORMAL, INVERTING	NORMAL	Defines the input polarity state
Pulse Input Mode	PULSE MODE KYZ MODE	PULSE MODE	Defines the type of a pulse on the input when it receives external pulses. In pulse mode, either leading, or trailing edge of the input pulse is accepted. In KYZ mode, both leading and trailing edges of the input pulse are accepted.
Pulse polarity	NORMAL (N.O.) INVERTING (N.C.)	NORMAL	Selects the active pulse edge that is considered a pulse in pulse mode. For normal polarity, the open to closed transition is considered a pulse. For inverting polarity, the closed to open transition is considered a pulse. It has no meaning in KYZ mode where both transitions are active.
Debounce time, ms	1-100 ms	1	The amount of time the state of the digital input should not change before being accepted as a new state. Too low debounce time could produce multiple events on the input change.

Using Analog Inputs

The BFM II can be equipped with up to three plug-in 4-channel Analog Input (4AI) modules. I/O numbers are automatically assigned to the analog inputs in the order of connection when the device is powered up.

The BFM II automatically converts the AI readings received from the analog-to-digital converter to the user-defined engineering scale and shows the input values in true engineering units, for example, in volts, amps, or degrees, with the desired resolution.

To configure the analog inputs in your device, select General Setup from the Meter Setup menu, and then click on the Analog Inputs tab. If you are programming your device online, Analog inputs that are not present in the device are designated as not available

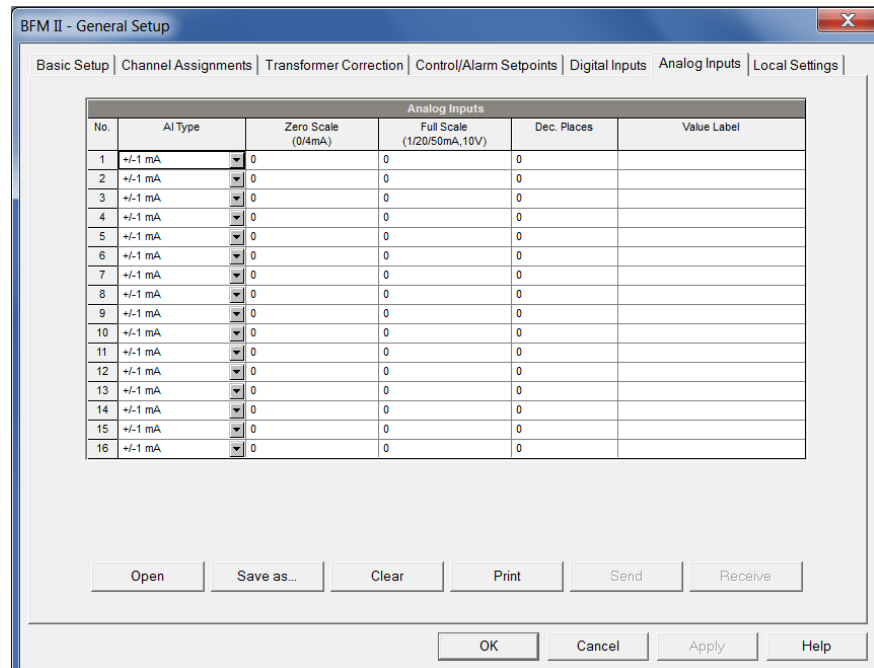

The available AI options are listed in the following table:

Option	Range	Description
AI type	mA ±1 mA 0-20 mA 4-20 mA 0-50 mA ±10 V	The AI module type. When connected to the device, shows the actual AI type read from the AI module.
Zero scale	0/4 mA	Defines the low engineering scale (in primary units) for the analog input corresponding to a lowest (zero) input current (0 or 4 mA, or 0 V)
Full scale	1/20/50 mA, 10V	Defines the high engineering scale (in primary units) for the analog input corresponding to a highest input current (1, 20 or 50 mA, or 10 V)
Dec. Places		The number of decimal digits in a fractional part of the scaled engineering value
Value label		An arbitrary name you can give the analog input value

NOTE:

Always save your AI setup to the site database in order to keep the labels you give the analog inputs. They are not stored in your device.

Scaling Non-directional Analog Inputs

When programming scales for non-directional analog inputs with a 0-1mA, 0-20mA or 4-20mA current option, provide both zero and full engineering scales. An example

is shown in the picture above for the 0-20 mA analog inputs. Each of the scales operates independently.

Scaling ± 1 mA Analog Inputs

When programming engineering scales for directional ± 1 mA analog inputs, you should provide only the engineering scale for the +1 mA input current. The engineering scale for the 0 mA input current is always equal to zero. The device does not allow you to access this setting. Whenever the direction of the input current is changed to negative, the device automatically uses your full engineering scale settings for +1 mA with a negative sign.

Scaling Analog Inputs for 0-2 mA and ± 2 mA

The input scales for 0-1 mA and ± 1 mA analog inputs are always programmed for 0 mA and +1 mA regardless of the desired input range. If you want to use the entire input range of 2 mA or ± 2 mA, set the analog input scales in your device as follows:

- **0-2 mA:** set the 1 mA scale to 1/2 of the required full scale output for uni-directional parameters, and set the 0 mA scale to the negative full scale and the 1 mA scale to zero for bi-directional parameters;
- **± 2 mA:** set the 1 mA scale to 1/2 of the required full-scale output for both uni-directional and bi-directional parameters.

For example, to convert voltage readings from the analog transducer that transmits them in the range of 0 to 2 mA to the range 0 to 120V, set the full range for the +1 mA analog input to 60V; then the 2 mA reading is scaled to 120V

Using Alarm/Control Setpoints

BFM II has an embedded logical controller that runs different actions in response to user-defined internal and external events. Unlike a PLC, the BFM II uses a simplified programming technique based on setpoints that allows the user to program a required action based on a measured analog value or on a time. The controller provides up to 4 setpoints for each submeter.

This setup allows configuring setpoints for each individual submeter. It can be read and changed via the corresponding submeters address.

To program the setpoints for a submeter, select General Setup from the Meter Setup menu, and then click on the Control/Alarm Setpoints tab.

The screenshot shows the 'BFM II - General Setup' window with the 'Control/Alarm Setpoints' tab selected. The window has a menu bar with options: Control/Alarm Setpoints, Periodic Timers, Pulse/Event Counters, Digital Inputs, Relay Outputs, Local Settings, Basic Setup, Transformer Correction, Channel Assignment, and Display Setup. Below the menu bar is a table for configuring setpoints.

No.	Trigger parameter	Operate limit	Release limit	Operate delay	Release delay	Action
1	MINUTES	10	NONE	0.0	0.0	DATA LOG #1
2	----	----	----	----	----	----
3	----	----	----	----	----	----
4	----	----	----	----	----	----
5	----	----	----	----	----	----
6	----	----	----	----	----	----
7	----	----	----	----	----	----
8	----	----	----	----	----	----
9	----	----	----	----	----	----
10	----	----	----	----	----	----
11	----	----	----	----	----	----
12	----	----	----	----	----	----
13	----	----	----	----	----	----
14	----	----	----	----	----	----
15	----	----	----	----	----	----
16	----	----	----	----	----	----

At the bottom of the window, there are buttons for 'Open', 'Save as...', 'Default', 'Print', 'Send', 'Receive', 'OK', 'Cancel', 'Apply', and 'Help'.

The following table describes the setpoint options.

Option	Range	Description
Trigger parameter	See Appendix D	The trigger parameter that is used as an argument in the logical expression
Operate limit		The threshold (in primary units) at which the conditional expression would be evaluated to true. Not applicable for time triggers.
Release limit		The threshold (in primary units) at which the conditional expression would be evaluated to false. Defines the hysteresis for analog triggers. Not applicable for digital triggers.
Operate delay	0.1-999.9 sec	The time delay before operation when the operate conditions are fulfilled
Release delay	0.1-999.9 sec	The time delay before release when the release conditions are fulfilled
Action	See Appendix D	The action performed when the setpoint expression is evaluated to true (the setpoint is in operated state)

Using Numeric Triggers

For numeric (analog) triggers, a setpoint allows you to specify two thresholds for each trigger to provide hysteresis (dead band) for setpoint operations. The operate limit defines the operating threshold, and the second release limit defines the release threshold for the trigger. If you do not want to use hysteresis for the trigger, set the release limit to the same as the operate limit.

Using Time Triggers

If you want the setpoint actions to be synchronized with the clock, for example, to provide recording interval data, use the minute time interval trigger that generates periodic events synchronized with the device clock.

Delaying Setpoint Operations

Two optional delays can be added to each setpoint to extend monitoring a setpoint trigger for a longer time before making a decision on whether the expected event occurred or not. When a delay is specified, the logical controller will change the setpoint status only if all conditions are asserted for a period at least as long as the delay time.

Using Setpoint Events

When a setpoint status changes, i.e., a setpoint event is either asserted or de-asserted, the following happens in your device:

1. The new setpoint status is logged to the setpoint status register that can be monitored via communications from the user application software in order to give a real-time indication on the expected event.
2. The operated setpoint status is latched to the setpoint alarm register accessible through communications. The register holds the last setpoint alarm status until it is explicitly cleared via communications.

Recording Setpoint Events

Time-tagged setpoint events can be recorded to the submeter event log if you select it as the setpoint action. The Event recorder logs any setpoint transition event: both when the setpoint is operated, and when it is released.

Using Counters

The BFM II has 72 nine-digit signed counters that count different events. Each counter is independently linked to any digital input and count input pulses with a programmable scale factor. You can link a number of digital inputs to the same counter. Each counter can be incremented or decremented through the Control Setpoints in response to any internal or external event.

To configure the device counters, select General Setup from the Meter Setup menu, and then click on the Counters tab.

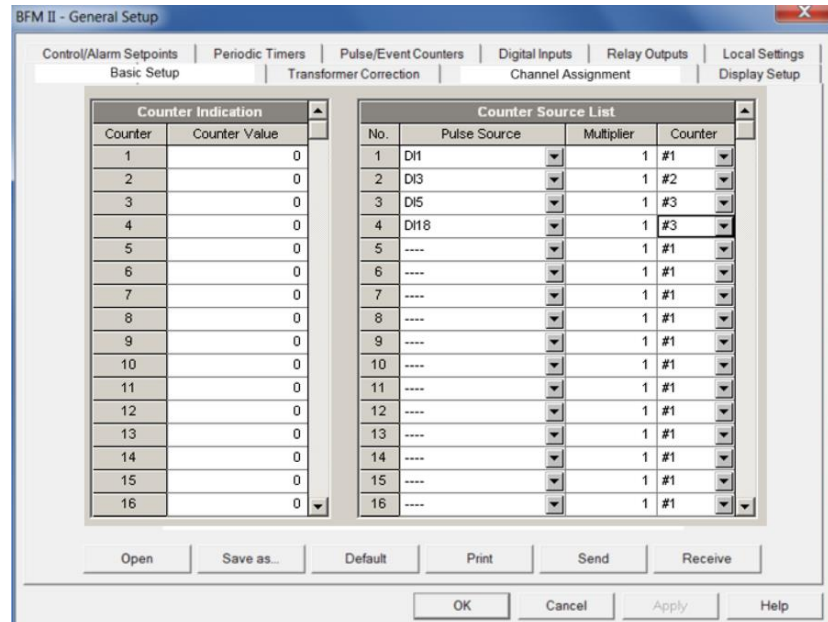

The available options are described in the following table:

Option	Range	Default	Description
Counter Setup			
Counter value	-999,999,999 - 999,999,999	0	The value written to the counter at reset
Counter Source Setup			
Pulse source	None, DI1-DI72	None	Links a digital input to the counter
Multiplier	-10,000 to 10,000	1	The value added to the counter when a pulse is detected on the pulse source input
Counter	1-72	1	Defines the target counter for the pulse source input

Configuring the Fault Recorder

The Fault recorder automatically records all fault events to the Fault log file. It can be triggered via the embedded fault detector, or externally through any of the 48 digital inputs.

The Fault recorder can be globally disabled or enabled in your device.

The Fault recorder setup allows you to adjust thresholds and hysteresis for different fault triggers, and to define the waveform and data log options for synchronous recording during the fault events.

To configure the Fault recorder:

1. Select Memory/Log from the Meter Setup menu, and then click on the Fault Recorder tab.

Fault Triggers										
Fault Event	Trigger #1	Threshold, %	Threshold, secondary	Hysteresis, %	Trigger Enabled	Trigger #2	Threshold, %	Threshold, secondary	Hysteresis, %	Trigger Enabled
DI	External Trigger	----	----	----	<input checked="" type="checkbox"/>	----	----	----	----	<input type="checkbox"/>
FE1	Zero-Seq. Current	5.0	0.25 A	5.0	<input type="checkbox"/>	----	----	----	----	<input type="checkbox"/>
FE2	Zero-Seq. Voltage	5.0	6.0 V	5.0	<input type="checkbox"/>	----	----	----	----	<input type="checkbox"/>
FE3	Current Unbalance	5.0	----	5.0	<input type="checkbox"/>	----	----	----	----	<input type="checkbox"/>
FE4	Voltage Unbalance	5.0	----	5.0	<input type="checkbox"/>	----	----	----	----	<input type="checkbox"/>
FE5	Overcurrent	150.0	7.50 A	5.0	<input checked="" type="checkbox"/>	Undervoltage	90.0	108.0 V	5.0	<input type="checkbox"/>
FE6	Undervoltage	90.0	108.0 V	5.0	<input checked="" type="checkbox"/>	----	----	----	----	<input type="checkbox"/>
FE7	In Current	5.0	0.25 A	5.0	<input type="checkbox"/>	----	----	----	----	<input type="checkbox"/>

Fault Recording									
Waveform Log			1 cycle RMS Trend				Distance to Fault		
Log on Start	Log on End	Log No.	Log Enabled	Max. Duration, cycles	Before, cycles	After, cycles	Data Log No.	Log Enabled	Data Log No.
<input checked="" type="checkbox"/>	<input checked="" type="checkbox"/>	1	<input checked="" type="checkbox"/>	100	4	4	13	<input type="checkbox"/>	----

Recorder Enabled
 Record to PQ Log

Open Save as... Default Print Send Receive

OK Cancel Apply Help

2. Enable fault triggers suitable for your application. Each one, except of the external digital triggers, must be individually enabled for the Fault recorder.
3. If you wish to change the default settings, adjust thresholds and hysteresis for your fault triggers.
4. Select the waveform and data logging options for fault events.
5. Download your setup to the device.

The following table lists available Fault recorder options:

Option	Range	Default	Description
Thresholds			
Threshold, %	0-200.0%		Defines the operating threshold for the fault trigger in percent of the nominal (reference) value
Threshold, secondary			Shows the setup value in secondary units for the selected operating threshold
Hysteresis, %	0-50.0%	5.0	Defines the hysteresis for fault trigger in percent of the threshold
Trigger Enabled	Checked Unchecked	Checked	Links the fault trigger to the Fault Recorder. If the box is leaved unchecked, the Fault Recorder does not respond to the trigger.
Waveform Log			
On Start	Checked Unchecked	Checked	Enables waveform log when the fault event starts
On End	Checked Unchecked	Unchecked	Enables waveform log when the fault event ends
Log No.	1	1	Specifies the waveform log file used for waveform recording on the fault event

Option	Range	Default	Description
1-cycle RMS Plot			
Log Enabled	Checked Unchecked	Unchecked	Enables concurrent RMS trace plot to the data log file while the fault event continues
Max. Duration	0-10,000 cycles	100	Maximum duration of the 1/2-cycle data trend log. The logging is stopped automatically when either a fault event ends or the specified number of cycles has been recorded.
Before, Cycles	0-20 cycles	4	The number of cycles to be recorded prior to the event
After, Cycles	0-20 cycles	4	The number of cycles to be recorded after the event
Log No.	13	13	Specifies the data log file used for data recording on the fault event

To enable or disable the Fault recorder in your device:

1. Check or uncheck the “Recorder Enabled” checkbox.
2. Send the new setting to the device.

Configuring Analog Triggers

Voltage and current thresholds are normally specified as a percent of a nominal (reference) voltage and current. The reference value for current triggers is the CT secondary current rating for the extended range current inputs.

To make easier specifying thresholds for voltage and current triggers, PAS also shows you threshold values in secondary units that match the percentage you selected for the triggers. To update the thresholds in secondary units, type the threshold for a trigger in percent, and then press Enter or click elsewhere on the Fault Recorder setup tab.

The picture above shows the factory set Fault recorder options. Notice that the Overcurrent trigger can be used along with the second Undervoltage trigger combined by logical AND. If you wish to use the only Overcurrent trigger, disable (uncheck) the second Undervoltage trigger.

The **Zero-Sequence Voltage** trigger and the **Voltage Unbalance** trigger are disabled by default. Both are very sensitive to phase unbalances. If you want to use them, adjust the thresholds according to your network conditions before enabling triggers.

The **Current Unbalance** trigger has a different calculation algorithm than the common current unbalance measurements. Since the unbalance readings give a relation of the maximum deviation from the average to the phase average current, the value could produce high readings for low currents and may not be used as a fault trigger. The Current Unbalance trigger used with the Fault recorder shows a relation to the CT rated current instead of the three-phase average and is not sensitive to low currents.

Digital Triggers

The external triggering is enabled for the Fault recorder by default and cannot be disabled by the user. DI's have a fixed mapping to SM's. DI #1 is mapped to SM #1, DI #2 is mapped to SM #2, etc.

Display Setup

(Future)

Select General Setup from the Meter Setup menu, and then click on the Display Setup tab.

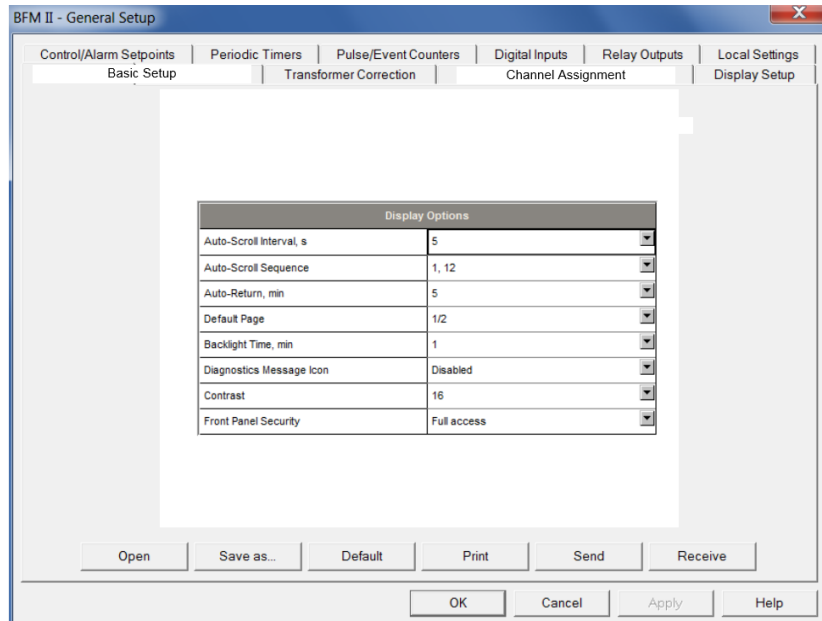

The Display Setup consists of Displays Options parameters Displays setup menus.

The available display options are listed in the table below.

See [Display Operations](#) in Chapter 3 for more information on display functionality and configuring display options. See [Data Displays](#) for information on display page contents and enumeration.

Display Label	Parameter	Options	Default	Description
Auto-Scroll	Auto-Scroll Interval	Disabled, 2-10, 15, 20, 25, 30 seconds	5	Defines the display scroll interval or disables auto-scroll
Scroll Sequence	Auto-Scroll Sequence	1 1-2 1-3 1-4 1-5 1-6 1-6, 10 1-6, 10-11 1-6, 10-12 1, 5, 10-12 1-2, 5, 10-12 1-3, 5, 10-12 1, 6, 10-12 1-2, 6, 10-12 1-3, 6, 10-12 1-4, 6, 10-12 1, 10-12 1-2, 10-12 1-3, 10-12 1-4, 10-12 1, 11-12 1-2, 11-12 1-3, 11-12 1-4, 11-12 1, 12 1-2, 12 1-3, 12 1-4, 12	1, 12	Selects the display sequence for auto-scrolling from 15 data displays (see Data Displays for display enumeration)
Auto-Return	Auto-Return	Disabled, 1-5, 10, 15, 20, 25, 30 min	5	Defines the time delay before returning to the default page

Display Label	Parameter	Options	Default	Description
Default Page	Default Page	1/2 - 1/10 2/1 - 2/10 ... 12/1-12/10	1/2	Specifies the default display/page. If a page is not available in present mode, the following available page will be displayed.
Backlight Time	Backlight Time	Continuous, 1-10 min	1	Defines the time while the backlight is ON
Diagnostic Icon	Diagnostic Message Icon	Disabled Enabled	Enabled	Disables/enables the blinking diagnostic icon in the data displays
Contrast	Contrast	1-25	1	Defines the display contrast
Front Panel Access mode	Front Panel Security	Full access, View only	Full access	At full access mode, the user is able to use buttons to navigate and/or setup device meter parameters. At View only mode, navigation buttons is disabled and the displays scrolls according to the Auto-Scroll setup

Configuring Billing Energy and TOU Registers

The BFM II provides eight total/summary energy and eight parallel tariff energy and maximum demand registers for each individual submeter. The registers can be linked to any internal energy source or to another submeter.

The meter tariff structure supports eight different tariffs using an arbitrary tariff schedule. A total of four types of days and four seasons are supported with up to eight tariff changes per day.

The meter can provide automatic daily profile recording for total and tariff energy and maximum demand registers. The device memory is sufficient to store daily profile data for 500 days.

By default, the first billing register in your meter is linked to the kWh IMPORT accumulator, and the daily profile recording is enabled for the kWh register. Other billing registers are not operational. To activate the remaining registers or to change the profile for the first billing register:

1. Link the Summary/TOU registers to the respective energy sources, and then configure the options for these registers like whether the only totalization or both total and tariff registers would be used, and whether daily profiling should be enabled for the energy usage and maximum demand registers.
2. Configure the daily tariff schedule for all types of days and seasons using the TOU daily profiles.
3. Configure the season tariff schedule using the TOU calendar.

Setting up Total and Tariff Registers

To configure the device total (summary) and TOU registers, select Energy/TOU from the Meter Setup menu.

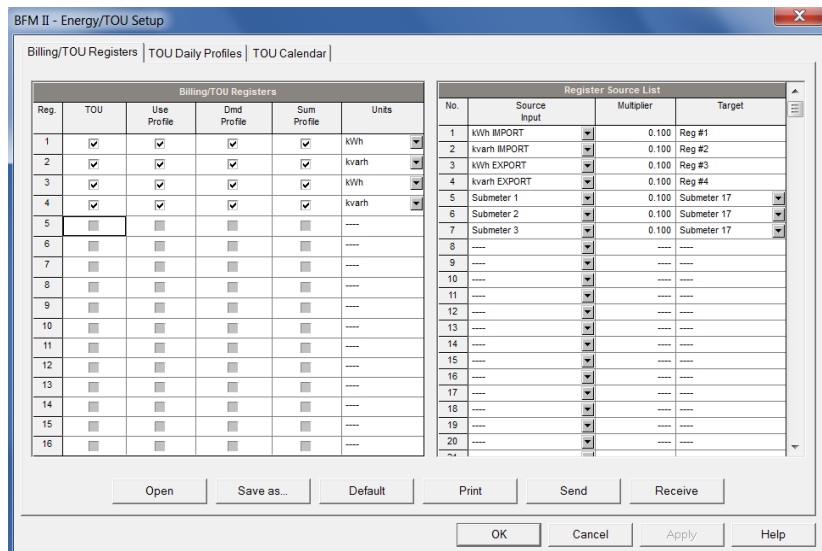

The available options are shown in the following table:

Parameter	Options	Default	Description
Billing/TOU Registers			
TOU	Unchecked Checked	Unchecked	Links tariff registers to the selected energy source
Use Profile	Unchecked Checked	Unchecked	Enables automatic daily profiling for energy usage registers (both total and tariff registers if TOU is enabled)
DMD Profile	Unchecked Checked	Unchecked	Enables automatic daily profiling for maximum demand registers (both total and tariff registers if TOU is enabled)

Parameter	Options	Default	Description
Billing/TOU Registers			
Sum Profile	Unchecked Checked	Unchecked	Enables daily profiling for summary registers (total of all tariffs). Automatically set when profiling is enabled.
Units	kWh, kvarh, kVAh	None	The register measurement units. It is set automatically.
Register Source List			
Source Input	None kWh IMPORT kWh EXPORT kvarh IMPORT kvarh EXPORT kVAh TOTAL Submeter 1 - Submeter 60 ¹	None	Links an energy source to the target register of all metering submeters, or links all registers of a source submeter to a totalization submeter.
Multiplier	0.001 to 100.000	0.100	The multiplication factor for the energy source.
Target	Reg#1- Reg#8 Submeter 1 - Submeter 40 ¹	None	Defines the target register for the energy source. It is set automatically for target energy registers.

¹ Linking a submeter to another totalization submeter connects all its configured energy registers to the corresponding registers of the target submeter.

Totalization Submeters

If you wish to automatically totalize energy measured by a number of submeters by using a separate totalization submeter, select a source submeter in the Source Input column on the Register Source List pane (starting with source 5), and then select the desired target totalization submeter in the Target column. Repeat these steps for all source submeters while selecting the same totalization submeter as the target.

Selecting a submeter as a target automatically connects all active energy registers of the source submeters to its energy registers, thus making it a totalization submeter. Note that each totalization submeter takes its own communication address in a sequential order along with the metering submeters (see [Submeter Addressing](#)).

Configuring the Daily Tariff Schedule

To configure your daily tariff schedule, select Energy/TOU from the Meter Setup menu, and then click on the TOU Daily Profiles tab.

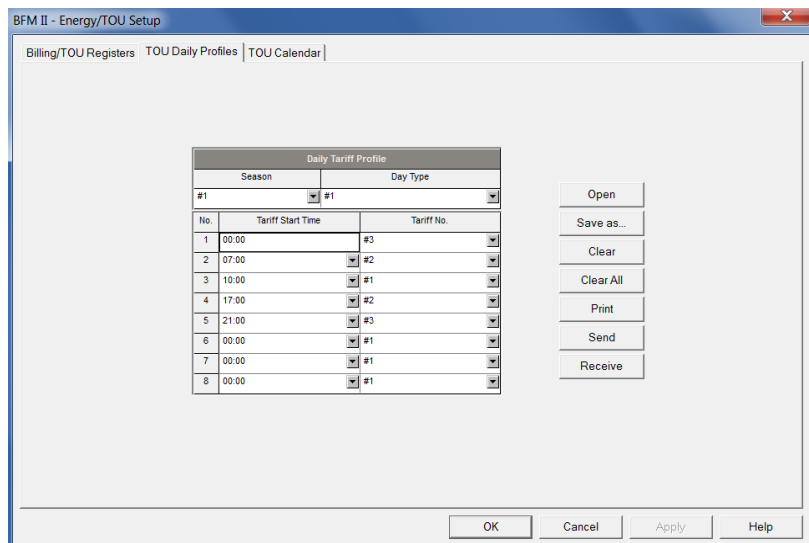

The daily profile setup allows you to specify the daily tariff change points with a 15-minute resolution for six tariffs and four seasons.

To configure your daily profiles:

1. Select the desired season and day type.
2. Select the start time for each tariff change point and the corresponding active tariff number.
3. Repeat the setup for all active profiles.

The first tariff change point is fixed at 00:00 hours, and the last tariff change you specified will be in use until 00:00 hours on the next day.

The energy daily profile log will be automatically configured for the number of active tariffs you defined in the BFM II TOU daily profile.

Configuring the Season Tariff Schedule

To configure your season tariff schedule, select Energy/TOU from the Meter Setup menu, and then click on the TOU Calendar tab.

The TOU calendar allows you to configure any tariff schedule based on any possible utility regulation. The calendar itself has 32 entries that allow you to specify profiles for working days and holidays through all seasons in any order that is convenient for you, based on simple intuitive rules. There are no limitations on how to define your schedule. The BFM II is able to automatically recognize your settings and to select a proper daily tariff schedule for any day within a year.

1. The following picture gives you an example of a single-season tariff schedule configured for weekends and the designated US holidays.

No.	Season/Period	Day Type	Week of Month	Weekday	Till Weekday	Month	Day	Till Month	Till Day	Year
1	#1	#1	---	Monday	Friday	June	----	October	----	----
2	#1	#2	---	Saturday	Sunday	June	----	October	----	----
3	#2	#1	---	Monday	Friday	November	----	April	----	----
4	#3	#3	---	Saturday	Sunday	November	----	May	----	----
5	#2	#2	---	---	---	January	----	January	1	----
6	#2	#2	Third	Monday	Monday	February	----	February	----	----
7	#2	#2	---	---	---	May	----	May	26	----
8	#1	#2	---	---	---	July	----	July	4	----
9	#1	#2	First	Monday	---	September	----	September	----	----
10	#2	#2	---	---	---	November	----	November	11	----
11	#2	#2	Fourth	Thursday	---	November	----	November	----	----
12	#2	#2	---	---	---	December	----	December	25	----
13	#4	#4	---	---	---	May	----	May	27	----
14	----	----	----	----	----	----	----	----	----	----
15	----	----	----	----	----	----	----	----	----	----
16	----	----	----	----	----	----	----	----	----	----
17	----	----	----	----	----	----	----	----	----	----
18	----	----	----	----	----	----	----	----	----	----
19	----	----	----	----	----	----	----	----	----	----
20	----	----	----	----	----	----	----	----	----	----

To configure your season tariff schedule:

1. In the “Season” box, select the season, and in the “Day Type” box, select a day type for this calendar entry.
2. Select the time interval when this daily tariff schedule will be effective based on the start and the end weekdays and, for a multi-season schedule, on the start and the end month for the selected season. It does not matter which order of weekdays or months you selected: the BFM II recognizes the correct order.
3. For exception days such as holidays, select a specific day either by specifying a day and month, or by selecting a month, a week and a weekday within the month.

Configuring Data Recorders

The BFM II provides a separate Data recorder for each metering submeter. The recorder is triggered via a setpoint periodically for recording interval data (see [Using Alarm/Control Setpoints](#)).

The device memory is factory partitioned to allow recording one data log file per submeter (Data Log #1) with a maximum of 17000 records per file. A data log file is

organized as a wrap-around file that needs not to be cleared explicitly though it can be done via PAS (see [Clearing Maximum Demands and Log Files](#)). When a file is filled up, the new records overwrite oldest records, so a file always keeps the 17000 latest records.

The Data recorder is programmable to record up to sixteen data parameters per record. The list of parameters is configured individually for each submeter and can be read and changed via the corresponding submeter's address.

To configure the data log for a submeter:

1. Select Log Setup from the Meter Setup menu.

No.	Group	Parameter	No.	Group	Parameter
1	ENERGY	kWh MPORT	9	N/A	N/A
2	ENERGY	kWh EXPORT	10	N/A	N/A
3	ENERGY	kvarh MPORT	11	N/A	N/A
4	ENERGY	kvarh EXPORT	12	N/A	N/A
5	AVR TOTAL	kW	13	N/A	N/A
6	AVR TOTAL	PF	14	N/A	N/A
7	N/A	N/A	15	N/A	N/A
8	N/A	N/A	16	N/A	N/A

2. Configure the list of parameters to be recorded in the data log file. See [Parameters for Data Monitoring and Logging](#) in Appendix C for a list of the available parameters.
3. Add the name for your data log file in the Name box. It will appear in the data log reports.
4. Save your new setup to the device database, and send it to the meter.
5. Configure a setpoint for periodic triggering the Data recorder using the MINUTE INTERVAL trigger (see [Using Alarm/Control Setpoints](#)).

Remote Device Control

This section describes some online operations on the BFM II you can perform through PAS. To access device control options you should have your device online.

DFR Data Recorders

For DFR there are additional files per SM:

- 3 general purpose DL's (in addition to DL #1)
- Log 13 - Fault Trend Data
- Fault Log
- WF Log

File	Type	Max. of Records
Data log #2	Wrap around	17000
Data log #3	Wrap around	17000
Data log #4	Wrap around	17000
Data log #13 (fault data trend)	Wrap around	17000
Waveform log	Wrap around	500
Fault log	Wrap around	1000

Waveform Log Configuration

1. Click "Setup Recorder", or click on the "Waveform Recorder" tab.

The following table lists available waveform options.

Option	Range	Description
Samples per Cycle	32, 64 samples/cycle	Defines the sampling rate for the waveform log
Before Cycles	1-20	Defines the number of cycles to be recorded prior to the event
Num. of Channels	1-26	The number of the simultaneously recorded channels

2. Select the sampling rate for waveforms.
3. Select the number of cycles to be recorded prior to the event, and a total number of cycles in the waveform.
4. Add the name for your waveform log file in the "Name" box. It will appear in the waveform reports.

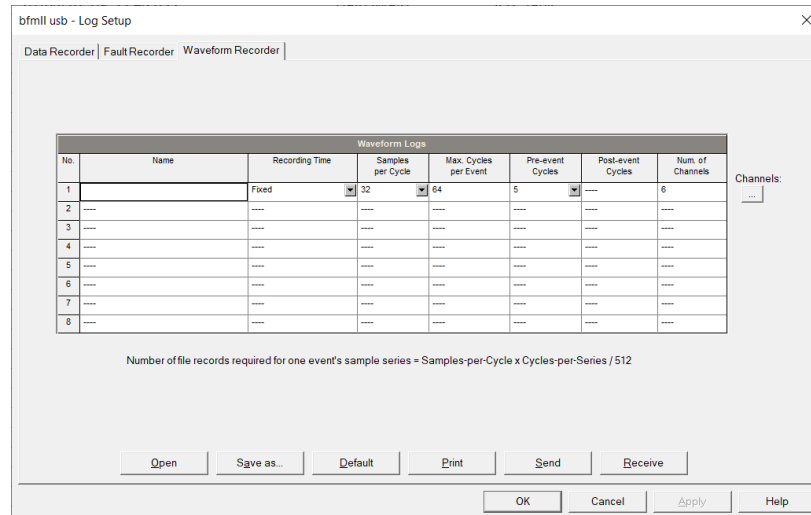

- To select the channels, click on the “Channels” button, check the boxes for channels to be recorded, and then click OK.

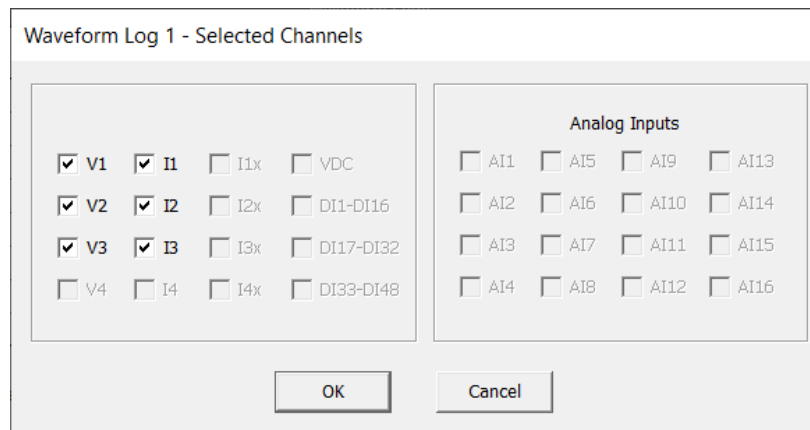

- Save your waveform setup to the site database, and send it to the device.

The picture above shows the factory preset waveform logs.

Factory Preset Periodic Data Logs

Data logs #1 and #2 are factory preset for periodic recording of the standard power quantities as shown in the following table.

No.	Parameter	No.	Parameter
Data Log #1			
1	RT (1-cycle) V1	9	RT (1-cycle) Total kVA
2	RT (1-cycle) V2	10	RT (1-cycle) Total PF
3	RT (1-cycle) V3		
4	RT (1-cycle) I1		
5	RT (1-cycle) I2		
6	RT (1-cycle) I3		
7	RT (1-cycle) Total kW		
8	RT (1-cycle) Total kvar		
Data Log #2			
1	kW Import Sliding Demand	9	I1 Demand
2	kvar Import Sliding Demand	10	I2 Demand
3	KVA Sliding Demand	11	I3 Demand

No.	Parameter	No.	Parameter
4	kWh Import	12	V1 Demand
5	kWh Export	13	V2 Demand
6	kvarh Import	14	V3 Demand
7	kvarh Export		
8	kVAh		

Factory Preset Fault Log

Data log #13 is factory preset for RMS trending on the fault events and are intended for the use with the Fault recorder. The default Fault data log configuration is shown in the following table.

No.	Parameter	No.	Parameter
Data Log #13 (fault data trend)			
1	Generic V1		
2	Generic V2		
3	Generic V3		
4	Generic I1		
5	Generic I2		
6	Generic I3		
7	Generic In		
8	Generic V ZERO-SEQ		

DFR Set Points

Two new SP's have been added:

- Fault Event Active
- Fault Event Cleared

If there is any fault active in SM it will cause operation of SP. When no events remain active, the SP will be released.

Viewing and Clearing Device Diagnostics

To view or clear the device diagnostics status, check the On-line button on the PAS toolbar and select Device Control from the Monitor menu.

Refer to [Device Diagnostic Codes](#) in Appendix F for the list of diagnostic codes and their meanings. See [Device Diagnostics](#) in Chapter 2 for more information on the BFM II built-in diagnostics.

Click on the Clear button to clear the device diagnostics. You must be connected to the BFM II using the device base address to be able to clear the diagnostics status.

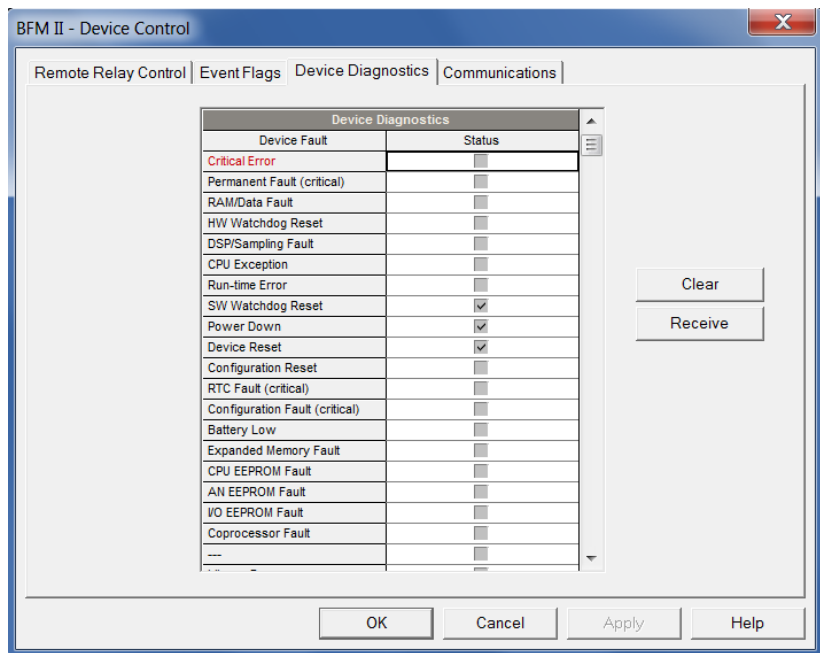

Updating the Clock

To update the RTC clock in your device, select a site with base device address from the list box on the toolbar, check the On-line button on the toolbar, and then select RTC from the Monitor menu.

The RTC dialog box displays the current PC time and the time in your device. To synchronize the device clock with the PC clock, click Set.

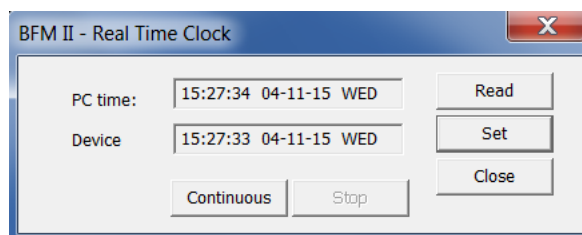

Clearing Maximum Demands and Log Files

PAS allows you to remotely clear maximum demands and log files individually in each submeter.

To open the dialog box, select a device site from the list box on the toolbar, check the On-line button, and then select Reset from the Monitor menu.

To reset the desired registers or to clear a file:

1. Click on the corresponding button, and then confirm your command.
2. If a target has more than one component, you are allowed to select components to reset.
3. Check the corresponding boxes and click OK.

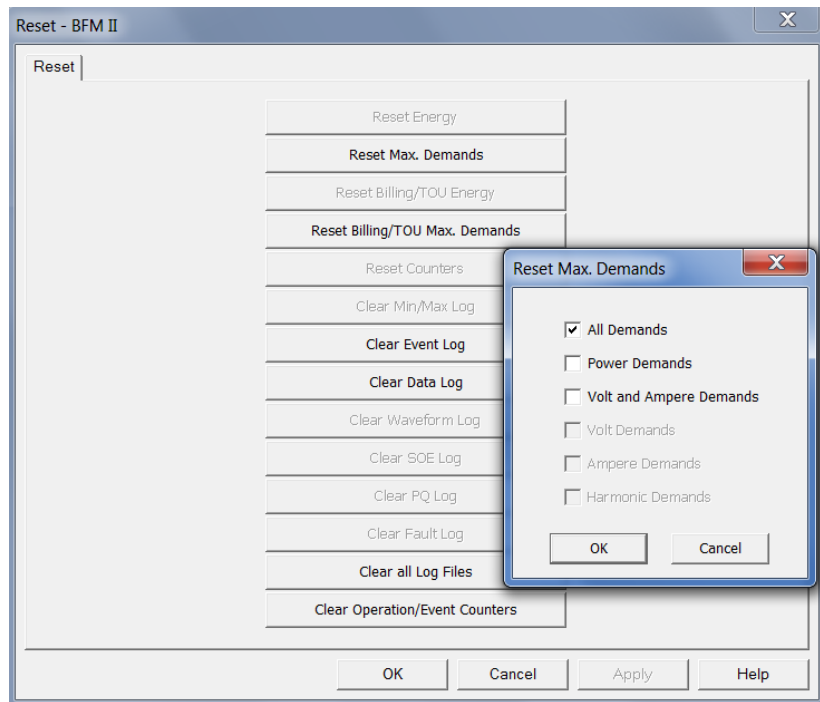

Administration

PAS allows you to remotely change the password or network security in your BFM II . Use the device base address to access your device.

To change the password, select a device site from the list box on the PAS toolbar, check the On-line button, click Administration from the monitor menu, and then select Change Password.

To change the password, type in a new 8-digit password, repeat the password in the Confirm box, and then click Send.



Upgrading Device Firmware

Your meter has upgradeable firmware. If you need to upgrade your device, you can download a new firmware file to the meter through PAS.

Firmware can be downloaded through any communication port. The meter can be connected to your PC through a serial interface, a dial-up modem, the Internet, or the RF modem.

Upgrading is only supported through the Modbus RTU and Modbus/TCP protocols, so your serial port or a dial-up modem port should be put into Modbus RTU mode.

NOTES

1. Ensure that stored data and configuration parameters setups are recorded before firmware download.
2. If firmware download process is interrupted for some reason or below instructions are not followed properly that can result in data loss

To download a new firmware file to your device:

1. Ensure that the communication port you are connected through to the meter operates in Modbus RTU mode (factory default).
2. If the port is configured for a different protocol, put it into Modbus RTU mode either from the front display, or remotely through PAS. If you are connected to the meter through a serial interface, it is recommended to set the port baud rate to 115,200 bps. See “Changing Port Settings” on how to remotely change the protocol and baud rate in your meter.
3. Check the On-line button on the PAS toolbar, select Flash Downloader from the Monitor menu, and then confirm changes.

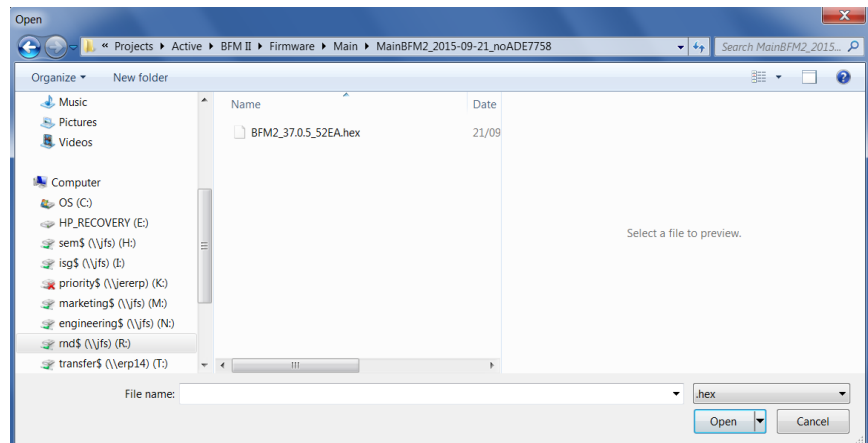

4. Point to the firmware upgrade file for your BFM II, click Open, and then confirm upgrading the device. You would be asked for the password regardless of the password protection setting in your BFM II.

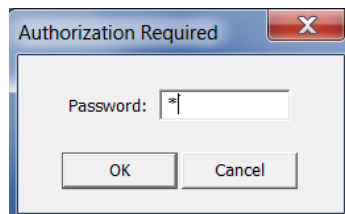

5. Type the device password, and click OK.

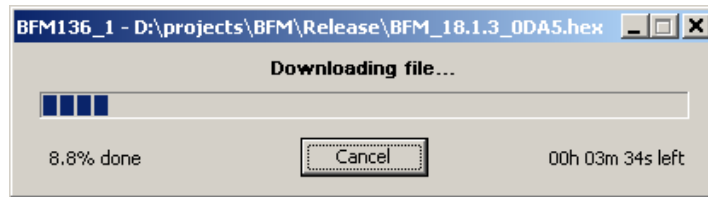

6. Wait until PAS completes upgrading your device. It would take about 3-4 minutes at 115,200 bps to download the file to the device.



After upgrading firmware is completed, the device restarts. If the meter is connected to your PC through the modem, communications can be temporarily lost and you may need to wait until PAS restores a connection with your device.

Data Monitoring

Viewing Real-Time Data

Real-time data can be continuously retrieved from the BFM II submeters, updated on the screen at the rate you defined in the Instrument Setup, and recorded to a file. You can view acquired data in a tabular or in a graphical form as a data trend.

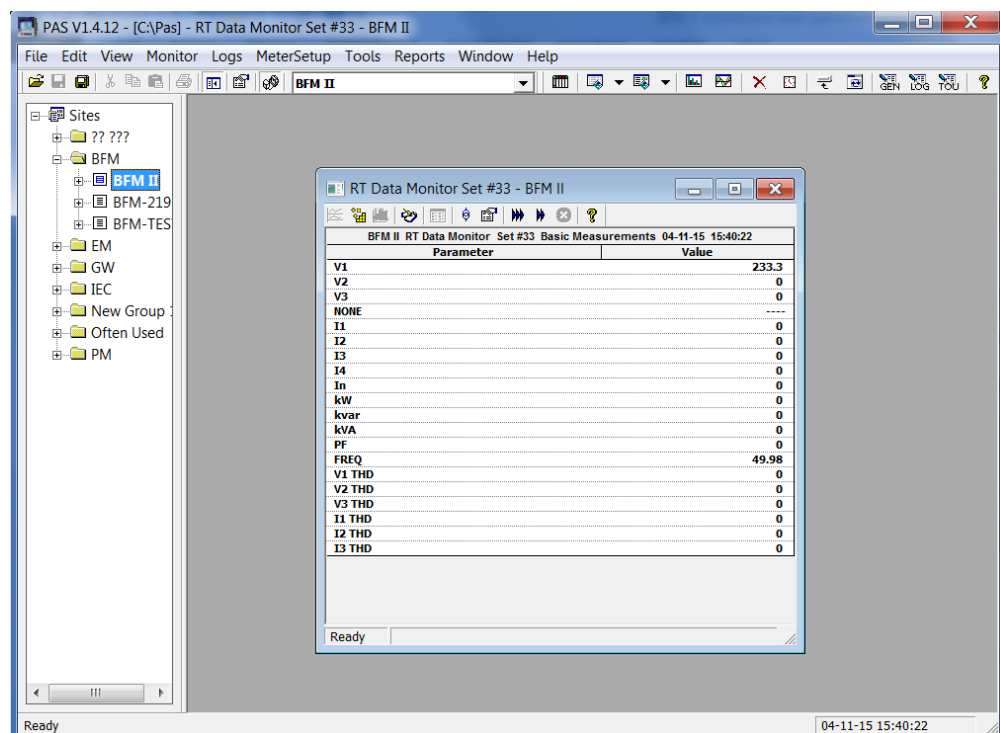

For information on the real-time data monitoring and recording options, see the PAS Getting Started Guide.

To get data from all submeters in a single window, click on the Multi-meter View button on the local toolbar.

Any energy and maximum demand registers in the BFM II submeters can be read and recorded to files through the PAS Data Monitor.

Retrieving Log Files

Using PAS, you can retrieve the event and data log files from the BFM II submeters and save them to files on your PC in the MS Access database format.

Historical data is uploaded on demand any time you need it, or periodically through the Upload Scheduler that retrieves data automatically on a predefined schedule, for example, daily, weekly or monthly. If you do not change the destination database location, new data is added to the same database so you can have long-term data trends and energy profiles in one database regardless of the upload schedule you selected.

For information on uploading files and configuring the Upload Scheduler for the BFM II submeters, see the PAS Getting Started Guide.

Retrieving the Event Log

The BFM II provides a separate Event log file for each metering submeter. All general device events, like device diagnostics, are recorded to the first Event log file that is accessed via the device base address.

Each Event log file is organized as a wrap-around file that keeps 2000 most recent events. The Event log files need not to be cleared explicitly though it can be done via PAS (see [Clearing Maximum Demands and Log Files](#)).

See the PAS Getting Started Guide for information on the event log viewing options.

Retrieving the Data Log and Daily Profile Log

Data log files are recorded and retrieved separately for each submeter. When uploading data log files refer to a regular data log file as Data Log #1, and to the daily profile data file as Data log #16.

BFMII-DFR: Retrieving the Data, WF, Trend and Fault Logs

Data logs #2, #3, #4 and #13 are recorded and retrieved in the same way as DL #1.

The WF and Fault logs are retrieved via the drop down menu of Logs.

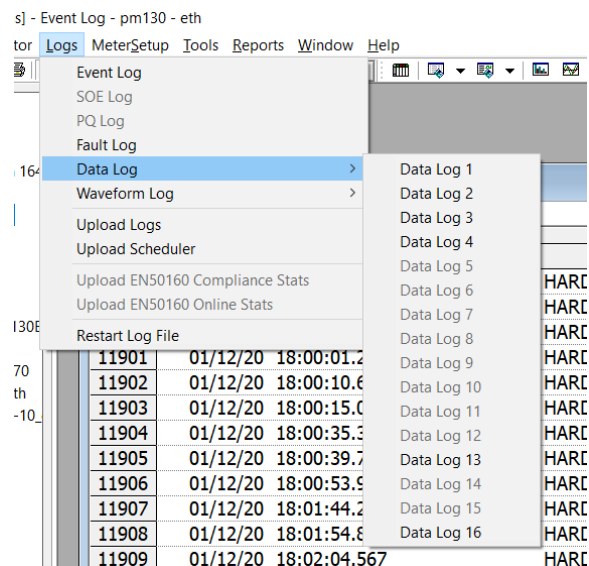

Viewing Daily Profile Data

Energy and maximum demand register's data is recorded to a separate table in the database. A daily profile record always contains the total energy reading of the register at the end of the day, and, if TOU is enabled for the register, readings of tariff registers for all tariffs defined in the daily tariff schedules.

Daily profile tables for energy and maximum demand registers are named as shown in the following picture.

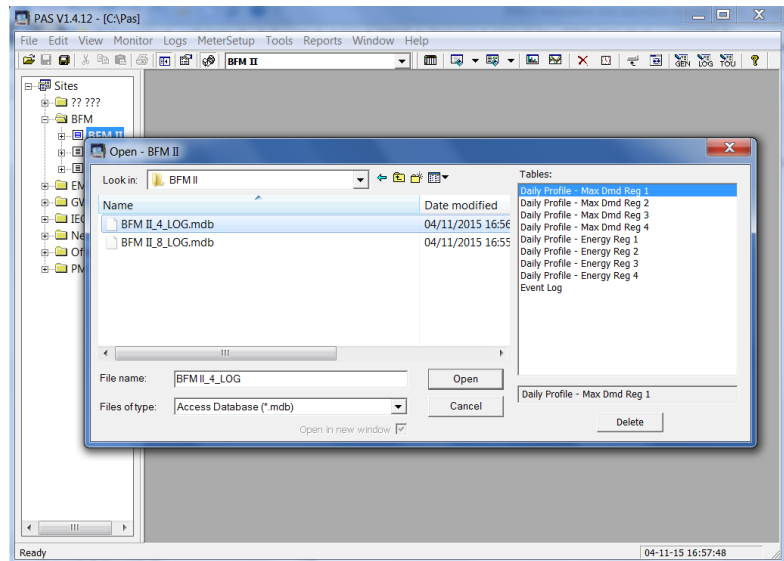

The following picture shows an example of energy profile data readings.

No.	Date/Time	Event	SUM REG1	SEASON TRF1	SEASON TRF2	SEASON TRF3
1	07-07-15 23:59:59.000		0	0	0	0
2	08-07-15 23:59:59.000		0	0	0	0
3	09-07-15 23:59:59.000		0	0	0	0
4	10-07-15 23:59:59.000		0	0	0	0
5	11-07-15 23:59:59.000		0	0	0	0
6	12-07-15 23:59:59.000		0	0	0	0
7	13-07-15 23:59:59.000		0	0	0	0
8	14-07-15 23:59:59.000		0	0	0	0
9	15-07-15 23:59:59.000		0	0	0	0
10	16-07-15 23:59:59.000		0	0	0	0
11	17-07-15 23:59:59.000		0	0	0	0
12	18-07-15 23:59:59.000		0	0	0	0
13	19-07-15 23:59:59.000		0	0	0	0
14	20-07-15 23:59:59.000		0	0	0	0
15	21-07-15 23:59:59.000		0	0	0	0
16	22-07-15 23:59:59.000		0	0	0	0
17	23-07-15 23:59:59.000		0	0	0	0

Appendix A Technical Specifications

Environmental Conditions

Operating Temperature (accuracy): -25°C to 60°C (-13°F to 140°F)
Storage Temperature: -40°C to 85°C (-40°F to 185°F)
Humidity: 0 to 95% non-condensing
Altitude ≤ 3000m

Construction

Overall Dimensions

Width: 278.00 mm (10.94 Inches) - 18 Ch. to 554.00 mm (21.81 Inches) - 54 Ch.
Height: 128.00 mm (5.04 Inches)
Depth: 72.50 mm (2.85 Inches)
Weight: 2.54 kg (5.6 lb)

Materials

Enclosure: Reinforced Polycarbonate
Panels: Polycarbonate
PCB: : FR4 (UL94-V0)
Terminals: PBT (UL94-V0)
Connectors-Plug-in type: Polyamide PA6.6 (UL94-V0)
Packaging Case: Carton and Stratocell (Polyethylene Foam) Brackets
Labels: Polyester film (UL94-V0)

Power Supply

Main Power Supply (self-energized PS)

Withstanding Insulation: 4kV AC @ 1mn, Installation category CAT III

3 Phase Power Supply through PT connection (3OP2/3OP3 connection) 3 x 57/100 - 120/208 VAC (±15%)

Burden for 120V: < 16 VA

3 Phase Power Supply direct connection (1, 2 or 3 phase operation) 3 x120/208 - 277/480 VAC (±15%)

Burden for 277V: < 24 VA

Voltage Inputs and Signal Ground Recommended Wire Size: 18 AWG (1 mm²), 600V isolation
Terminal pitch 10 mm, four pins and Signal Ground stud

Auxiliary Power Supply (module)

Withstanding Insulation: 4kV AC @ 1mn, Installation category CAT III

AC/DC Power Supply: L/+, N/- and GND

@ operating temperature range of -25°C to 60°C, Rated input: 50-290VAC 50/60 Hz,
40-290VDC, Maximum Power output 10W

@ operating temperature range of -40°C to 70°C, Rated input: 50-290VAC 50/60 Hz,
90-290VDC, Maximum Power output 10W

Recommended Wire Size: 18 AWG (1 mm²), 600V isolation
Terminal pitch 7.5 mm, three pins

Input Ratings

AC Voltage Inputs: V1, V2, V3, VN

PT connection (3OP2/3OP3 wiring) Measuring range: 3 x 57/100 - 120/208 VAC

Direct connection Measuring range: 3 x120/208 - 277/480 VAC

Impedance Input: 10MΩ

Burden for 277V ≈ 0.08 VA

Burden for 120V ≈ 0.02 VA

Galvanic Isolation, withstanding insulation: 4kV AC @ 1mn

Recommended Wire Size: 18 AWG (1 mm²), 600V isolation

Terminal pitch 10 mm

AC Current Inputs:

Standard: I1 - I54 - 40mA maximum input channel, HACS model

Input via SATEC HACS 100A to 3000A with 40mA secondary

Operating range: maximum continuous 120% I max: 120A for HACS 100A (Primary current)
Nominal measured Current: 15A RMS for HACS 100A (Primary current)
Maximum measured Current: 100A RMS for HACS 100A (Primary current)
Burden: < 0.15 VA
Overload Withstand: 120A RMS continuous, 750A (50 x In) for 1 second for HACS 100A
Recommended Wire Size: 18 AWG (1 mm²), 600V isolation
Terminal pitch: 5 mm

Optional: I1 - I54 - 10mA maximum input channel, RS5 model (primary In=5A)

Input via SATEC HACS 20A with 10mA secondary

Operating range: maximum continuous 120% I max: 24A for RS5 5A (Primary current)
Nominal measured Current: 5A RMS (Primary current)
Maximum measured Current: 20A RMS (Primary current)
Burden: < 0.15 VA
Overload Withstand: 80A RMS continuous, 250A (50 x In) for 1 second
Recommended Wire Size: 18 AWG (1 mm²), 600V isolation
Terminal pitch: 5 mm

Plug-In I/O Ratings

Digital Inputs – 4DI/4DO (future) or 9DI or 18DI (up to 4 modules)

Optically isolated input, dry contact sensing (voltage-free)

9/18DI module

Dry Contact option: Internal power supply 5 VDC
Wet Contact option: 24VDC, 48VDC, 125VDC or 250VDC

4DI/4DO module (future)

Dry Contact option: Internal power supply 24VDC
Wet Contact option: 24VDC, 48VDC, 125VDC or 250VDC

Sensitivity: open @ input resistance >16kOhm, closed @ input resistance <10kOhm
Scan time: 1cycle.

Withstanding Insulation: 4kV AC @ 1 mn
Recommended Wire Size: 18 AWG (1 mm²), 600V isolation
Terminal pitch: 3.81 mm

Relay Outputs – 9RO (up to 2 Modules)

9 relays - SPST Form A
Contact rating:
5A @ 250V AC, 5A @ 30V DC
Update time: 1 cycle
Recommended Wire Size: 18 AWG (1 mm²), 600V isolation
Terminal pitch: 3.81 mm

Relay Outputs – 4DI/4DO (up to 4 Modules - future)

4 relays - SPST Form A
Contact rating:
5A @ 250V AC, 5A @ 30V DC
0.15A @ 250V DC (sw. Volt.)
Update time: 1 cycle
Recommended Wire Size: 18 AWG (1 mm²), 600V isolation
Terminal pitch: 3.81 mm

Analog Inputs – 4 Inputs (up to 4 Modules)

4 Analog Inputs:

Ranges (upon order):
±1 mA (100% overload)
0-20 mA
4-20 mA
0-1 mA (100% overload)
Accuracy: 0.5% FS
Scan time: 2 cycles
Withstanding Insulation: 4kV AC @ 1 min
Recommended Wire Size: 18 AWG (1 mm²), 600V isolation
Terminal pitch: 3.81 mm

Communication Ports

COM1 – standard (MCM)

Serial EIA RS-485 optically isolated port
Withstanding Insulation: 4kV AC @ 1 min
Connector Type: removable, captured-wire, 3 terminals.
Terminal pitch: 5 mm
Recommended Wire Size: 18 AWG (1 mm²), 600V isolation
Baud Rate: up to 115,200 bps.
Supported Protocols: MODBUS RTU/ASCII, DNP 3.0

COM2 – optional (Communication Module)

Serial EIA RS-422/RS-485 optically isolated port
Withstanding Insulation: 4kV AC @ 1 min
Connector type: removable, captured-wire, 5 terminals.
Terminal pitch: 3.81 mm
Recommended Wire Size: 18 AWG (1 mm²), 600V isolation
Baud Rate: up to 115,200 bps.
Supported Protocols: MODBUS RTU/ASCII, DNP 3.0

COM3 – standard (MCM Display Communication port)

Serial TTL RS-232 non-isolated port for the GDM.
Baud Rate: up to 460,800 bps.
Supported Protocols: MODBUS RTU

USB Port – standard (MCM)

Isolated USB 1.1 port.
Withstanding Insulation: 4kV AC @ 1 min
Connector Type A male, standard USB cable, max. Length 2 meters
Supported protocols: MODBUS RTU

Ethernet Port – standard (MCM)

Transformer-isolated 10/100Base-T port
Withstanding Insulation: 4kV AC @ 1 min
Connector Type: RJ45 modular.
Supported Protocols: MODBUS TCP (Port 502), DNP 3.0/TCP (Port 20000),
Number of simultaneous connections (sockets): 5.

COM4 - CELLULAR – optional (Communication Module)

2G/3G CELLULAR MODEM
Withstanding Insulation: 4kV AC @ 1 min
Connector type: SMA
Supported Protocols: MODBUS TCP (Port 502), DNP 3.0/TCP (Port 20000)

Real-time Clock

Accuracy: maximum error 5 seconds per month @ 25°C

Log Memory

Standard onboard memory: 250 Mbytes.

Graphical Display Module - optional

GDM

3.5 Inch Touch-Panel LCD graphic TFT display
Resolution: 320 x 240
Operating temperature: -20°C - +70 °C
Communication:
Serial TTL RS-232 non-isolated port

Standards Specifications

EMC per IEC 62052-11, IEC 62053-22, ANSI C12.1 and ANSI C12.20

IEC61000-4-2: Electrostatic discharge, 15kV/8kV - air/contact
IEC61000-4-3: Electromagnetic RF Fields, 10V/m @ 80MHz - 1000MHz
IEC61000-4-4: Fast Transients burst, 4KV on current and voltage circuits and 2 KV for auxiliary circuits
IEC61000-4-5: Surge 6KV on current and voltage circuits and 1 KV for auxiliary circuits
IEC61000-4-6: Conducted Radio-frequency, 10V @ 0.15MHz - 80MHz
IEC61000-4-8: Power Frequency Magnetic Field
IEC61000-4-12: Damped oscillatory waves, 2.5kV CM and 1kV DM
IEC61000-4-19/TR 50579-2012: conducted disturbances in the frequency range 2 kHz – 150 kHz
ANSI C12.1 - 4.7.3.3.1: 100 kHz Ring Wave surge, 6kV @ 0.5kA (per IEEE C62.41.2-2002)
ANSI C12.1 - 4.7.3.3.2: line surge, 1.2/50 μ s - 8/20 μ s, 6kV @ 3kA (per IEEE C62.41.2-2002)
ANSI C12.1 - 4.7.3.11: SWC 2.5kV (per IEEE 37.90.1)
CISPR 22 - class B

Safety

UL/IEC 61010-1 3rd ed.:2012
NMI M6-1

Insulation

IEC 62052-11 (per NMI M6-1): Insulation impulse 12KV/50 Ω @ 1.2/50 μ s
IEC 62053-22: AC voltage tests related to ground, 4 kV AC @ 1min, for power and signal ports (above 40V), or according to UL 61010-1 3rd ed. for basic and/or double insulation and Installation Category III, Pollution degree 2

Environment Conditions

Accuracy Operational ambient temperature range: -25°C to +60 °C
Long-term damp heat withstand according to IEC 68-2-3 <95% (non-condensing), +40 °C
Transport and storage temperature range: -40°C to +85 °C
IEC 62052-11 (ref. IEC 60068-2-6): Vibration
Frequency range: 10Hz to 150Hz
Transition frequency: 60Hz
Constant movement amplitude 0.075mm, f < 60Hz
Constant acceleration 9.8 m/s² (1g), f > 60Hz
IEC 62052-11(ref. IEC 60068-2-27): Shock
Half sine pulse
Peak acceleration: 30g_n (300 m/s²)
Additional Transport vibration and shocks:
Longitudinal acceleration 2.0 g
Vertical acceleration 1.2 g
Transversal acceleration 1.2 g
IEC 60529: IP50
Installation category: III, Indoor use
Operating altitude >3000m

Accuracy

IEC/AZ 62053-22, class 0.2S
ANSI C12.20-2002, Class 100, 400, accuracy 0.2%
EN50470 Class C

Measurement Specifications

Parameter	Full Scale @ Input Range	Accuracy			Range
		% Reading	% FS	Conditions	
Voltage	$V_L = 120V$ $V_L = 230V$	0.05	0.05	100 to 300 V	0 to $V_{max} = 600 V$
Line current	Instrument current transformer CTs $I_L = 100A$	0.2	0.05	1 to 100% FS	0 to $I_{max} = 10,000A$ (HACS primary current) Starting current: 0.1% FS
Active power	$2 \times V_{max} \times I_L / 1000$, kW	0.2	0.02	$ PF \geq 0.5$ ¹	-120,000 to 120,000 kW
Reactive power	$2 \times V_{max} \times I_L / 1000$, kvar	0.2	0.02	$ PF \leq 0.9$ ¹	-120,000 to 120,000 kvar
Apparent power	$2 \times V_{max} \times I_L / 1000$, kVA	0.2	0.02	$ PF \geq 0.5$ ¹	0 to 120,000 kVA
Power factor	1.0	-	1.0	$ PF \geq 0.5$, $I \geq 2\%$ FSI	-0.999 to +1.000
Frequency		0.02	-	50 Hz: 39.00 to 65.00 Hz 60 Hz: 45.00 to 70.00 Hz	39 Hz up to 70 Hz
Active energy import/export ⁴		Class 0.2S under conditions as per IEC/AZ 62053-22			0 to 99,999,999.9 kWh
Reactive energy import/export		Class 0.2 under conditions as per ANSI C12.20:2002			
Reactive energy import/export		Class 0.5 under conditions as per IEC/AZ 62053-21:2003, $ PF \leq 0.9$			0 to 99,999,999.9 kvarh
Apparent energy		Class 0.5 under conditions as per IEC/AZ 62053-21:2003			0 to 99,999,999.9 kVAh

¹ @ 80% to 115% of voltage FS and 1% to 100% of current FS

FSV - voltage full scale

FSI - current full scale

Notes

- Accuracy is expressed as \pm (percentage of reading + percentage of full scale) ± 1 digit. This does not include inaccuracies introduced by the user's potential and current transformers. Accuracy calculated at 1-second average.
- Specifications assume: voltage and current waveforms with THD $\leq 5\%$ for kvar, kVA and PF; reference operating temperature: 20°C - 24°C.
- Measurement error is typically less than the maximum error indicated here.
- Accuracy of the device complies with IEC 62053-22 class 0.2S standard with solid core HACS and class 1 with split core HACS

Appendix B HACS Connection Template

Use the following table to memorize your input assignments and wiring connections for sub-consumers.

Customer / Site name:			Installation Date:		
#	Sub-consumer	Input #	Wire Color	Cable#	Phase
1					
2					
3					
4					
5					
6					
7					
8					
9					
10					
11					
12					
13					
14					
15					
16					
17					
18					
19					
20					
21					
22					
23					
24					
25					
26					
27					
28					
29					
30					
31					
32					
33					
34					
35					
36					

Appendix B HACS CONNECTION TEMPLATE

Customer / Site name:			Installation Date:		
#	Sub-consumer	Input #	Wire Color	Cable#	Phase
37					
38					
39					
40					
41					
42					
43					
44					
45					
46					
47					
48					
49					
50					
51					
52					
53					
54					

Upgrading BFM136 to BFM II (236)

The fact the BFM II is a modular device in terms of channels capacity, the channels numbering differ from the BFM 136, and the following table can be used to cross-reference the BFM136 installations with BFM II installation.

Customer / Site name:						Installation Date:			
#	Sub-consumer	BFM 136				BFM II 236			
		Input #	Wire Color	Cable #	Phase	Input #	Wire Color	Cable #	Phase
1									
2									
3									
4									
5									
6									
7									
8									
9									
10									
11									
12									
13									
14									
15									
16									
17									
18									
19									
20									
21									
22									
23									
24									
25									
26									
27									
28									
29									
30									
31									
32									
33									
34									
35									
36									

Appendix C Parameters for Data Monitoring and Logging

The following table lists parameters measured by the meter that are available for data logging and monitoring through communications. The left column shows data abbreviations used in PAS. Parameter groups are highlighted in bold.

Designation	Description
NONE	None (stub, read as zero)
RT PHASE	1-Cycle Phase Values
V1	V1
V2	V2
V3	V3
I1	I1 Current
I2	I2 Current
I3	I3 Current
Power and PF with sign	
kW L1	kW L1
kW L2	kW L2
kW L3	kW L3
kvar L1	kvar L1
kvar L2	kvar L2
kvar L3	kvar L3
kVA L1	kVA L1
kVA L2	kVA L2
kVA L3	kVA L3
PF L1	Power factor L1
PF L2	Power factor L2
PF L3	Power factor L3
V12	V12 Voltage
V23	V23 Voltage
V31	V31 Voltage
RT TOTAL	1-Cycle Total Values
kW	Total kW
kvar	Total kvar
kVA	Total kVA
PF	Total PF
RT AUX	1-Cycle Auxiliary Values
V UNB%	Voltage unbalance ²
In	In (neutral) Current ³
FREQ	Frequency
AVR PHASE	1-Second Phase Values ¹
V1	V1 Voltage
V2	V2 Voltage
V3	V3 Voltage
I1	I1 Current
I2	I2 Current
I3	I3 Current
Power and PF with sign	
kW L1	kW L1
kW L2	kW L2
kW L3	kW L3
kvar L1	kvar L1
kvar L2	kvar L2
kvar L3	kvar L3
kVA L1	kVA L1
kVA L2	kVA L2
kVA L3	kVA L3
PF L1	Power factor L1
PF L2	Power factor L2
PF L3	Power factor L3
V12	V12 Voltage
V23	V23 Voltage
V31	V31 Voltage
AVR TOTAL	1-Second Total Values ¹
kW	Total kW

Designation	Description
kvar	Total kvar
kVA	Total kVA
PF	Total PF
AVR AUX	1-Second Auxiliary Values ¹
V UNB%	Voltage unbalance ²
In	In (neutral) Current ³
FREQ	Frequency
DEMANDS	Present Demands ¹
V1 DMD	V1 Volt demand
V2 DMD	V2 Volt demand
V3 DMD	V3 Volt demand
I1 DMD	I1 Ampere demand
I2 DMD	I2 Ampere demand
I3 DMD	I3 Ampere demand
kW IMP SD	kW import sliding window demand
kvar IMP SD	kvar import sliding window demand
kVA IMP SD	kVA import sliding window demand
kW IMP ACC DMD	kW import accumulated demand
kvar IMP ACC DMD	kvar import accumulated demand
kVA IMP ACC DMD	kVA import accumulated demand
kW IMP PRD DMD	kW import predicted sliding window demand
kvar IMP PRD DMD	kvar import predicted sliding window demand
kVA IMP PRD DMD	kVA import predicted sliding window demand
kW EXP SD	kW Export sliding window demand
kvar EXP SD	kvar Export sliding window demand
kVA EXP SD	kVA Export sliding window demand
kW EXP ACC DMD	kW Export accumulated demand
kvar EXP ACC DMD	kvar Export accumulated demand
kVA EXP ACC DMD	kVA Export accumulated demand
kW EXP PRD DMD	kW Export predicted sliding window demand
kvar EXP PRD DMD	kvar Export predicted sliding window demand
kVA EXP PRD DMD	kVA Export predicted sliding window demand
SUMM ACC DMD	Summary (TOU Total) Accumulated Demands
SUM REG1 ACC DMD	Summary register #1 demand
SUM REG2 ACC DMD	Summary register #2 demand
SUM REG3 ACC DMD	Summary register #3 demand
SUM REG4 ACC DMD	Summary register #4 demand
SUM REG5 ACC DMD	Summary register #5 demand
SUM REG6 ACC DMD	Summary register #6 demand
SUM REG7 ACC DMD	Summary register #7 demand
SUM REG8 ACC DMD	Summary register #8 demand
SUMM SW DMD	Summary (TOU Total) Sliding Demands ¹
SUM REG1 SW DMD	Summary register #1 demand
SUM REG2 SW DMD	Summary register #2 demand
SUM REG3 SW DMD	Summary register #3 demand
SUM REG4 SW DMD	Summary register #4 demand
SUM REG5 SW DMD	Summary register #5 demand
SUM REG6 SW DMD	Summary register #6 demand
SUM REG7 SW DMD	Summary register #7 demand
SUM REG8 SW DMD	Summary register #8 demand
ENERGY	Submeter Energy ¹
kWh IMP	kWh import
kvarh IMP	kvarh import
kVAh IMP	kVAh import
kWh EXP	kWh export
kvarh EXP	kvarh export
kVAh EXP	kVAh export
KWh NET	KWh netto
Kvarh NET	Kvarh netto
KVAh TOT	KVAh total
SUMMARY REGS	Summary (TOU Total) Energy Registers ¹
SUM REG1	Summary energy register #1
SUM REG2	Summary energy register #2
SUM REG3	Summary energy register #3
SUM REG4	Summary energy register #4
SUM REG5	Summary energy register #5
SUM REG6	Summary energy register #6
SUM REG7	Summary energy register #7

Appendix C PARAMETERS FOR DATA MONITORING AND LOGGING

Designation	Description
SUM REG8	Summary energy register #8
MAX DMD	Maximum Demands
V1 DMD MAX	V1 Maximum volt demand
V2 DMD MAX	V2 Maximum volt demand
V3 DMD MAX	V3 Maximum volt demand
I1 DMD MAX	I1 Maximum ampere demand
I2 DMD MAX	I2 Maximum ampere demand
I3 DMD MAX	I3 Maximum ampere demand
kW IMP SD MAX	Maximum kW import sliding window demand
kW EXP SD MAX	Maximum kW export sliding window demand
kvar IMP SD MAX	Maximum kvar import sliding window demand
kvar EXP SD MAX	Maximum kvar export sliding window demand
kVA IMP SD MAX	Maximum kVA import sliding window demand
kVA EXP SD MAX	Maximum kVA export sliding window demand
MAX SUMMARY DMD	Billing Summary (Total) Maximum Demands
REG1 MD	Summary register #1 maximum demand
REG2 MD	Summary register #2 maximum demand
...	...
REG8 MD	Summary register #8 maximum demand
REG1 CMD	Summary register #1 cumulative maximum demand
REG2 CMD	Summary register #2 cumulative maximum demand
...	...
REG8 CMD	Summary register #8 cumulative maximum demand
TOU PRMS	TOU Parameters
ACTIVE TARIFF	Active TOU tariff
ACTIVE PROFILE	Active TOU profile
TOU REG1	Billing TOU Energy Register #1
REG1 TRF1	Tariff #1 register
REG1 TRF2	Tariff #2 register
...	...
REG1 TRF8	Tariff #8 register
TOU REG2	Billing TOU Energy Register #2
REG2 TRF1	Tariff #1 register
REG2 TRF2	Tariff #2 register
...	...
REG2 TRF8	Tariff #8 register
TOU REG3	Billing TOU Energy Register #3
REG3 TRF1	Tariff #1 register
REG3 TRF2	Tariff #2 register
...	...
REG3 TRF8	Tariff #8 register
TOU REG4	Billing TOU Energy Register #4
REG4 TRF1	Tariff #1 register
REG4 TRF2	Tariff #2 register
...	...
REG4 TRF8	Tariff #8 register
TOU REG5	Billing TOU Energy Register #5
REG5 TRF1	Tariff #1 register
REG5 TRF2	Tariff #2 register
...	...
REG5 TRF8	Tariff #8 register
TOU REG6	Billing TOU Energy Register #6
REG6 TRF1	Tariff #1 register
REG6 TRF2	Tariff #2 register
...	...
REG6 TRF8	Tariff #8 register
TOU REG7	Billing TOU Energy Register #7
REG7 TRF1	Tariff #1 register
REG7 TRF2	Tariff #2 register
...	...
REG7 TRF8	Tariff #8 register
TOU REG8	Billing TOU Energy Register #8
REG8 TRF1	Tariff #1 register
REG8 TRF2	Tariff #2 register
...	...
REG8 TRF8	Tariff #8 register
TOU MAX DMD REG1	Billing TOU Maximum Demand Register #1
REG1 TRF1 MD	Tariff #1 maximum demand
REG1 TRF2 MD	Tariff #2 maximum demand

Designation	Description
...	...
REG1 TRF8 MD	Tariff #8 maximum demand
REG1 TRF1 CMD	Tariff #1 cumulative maximum demand
REG1 TRF2 CMD	Tariff #2 cumulative maximum demand
...	...
REG1 TRF8 CMD	Tariff #8 cumulative maximum demand
TOU MAX DMD REG2	Billing TOU Maximum Demand Register #2
REG2 TRF1 MD	Tariff #1 maximum demand
REG2 TRF2 MD	Tariff #2 maximum demand
...	...
REG2 TRF8 MD	Tariff #8 maximum demand
REG2 TRF1 CMD	Tariff #1 cumulative maximum demand
REG2 TRF2 CMD	Tariff #2 cumulative maximum demand
...	...
REG2 TRF8 CMD	Tariff #8 cumulative maximum demand
TOU MAX DMD REG3	Billing TOU Maximum Demand Register #3
REG3 TRF1 MD	Tariff #1 maximum demand
REG3 TRF2 MD	Tariff #2 maximum demand
...	...
REG3 TRF8 MD	Tariff #8 maximum demand
REG3 TRF1 CMD	Tariff #1 cumulative maximum demand
REG3 TRF2 CMD	Tariff #2 cumulative maximum demand
...	...
REG3 TRF8 CMD	Tariff #8 cumulative maximum demand
TOU MAX DMD REG4	Billing TOU Maximum Demand Register #4
REG4 TRF1 MD	Tariff #1 maximum demand
REG4 TRF2 MD	Tariff #2 maximum demand
...	...
REG4 TRF8 MD	Tariff #8 maximum demand
REG4 TRF1 CMD	Tariff #1 cumulative maximum demand
REG4 TRF2 CMD	Tariff #2 cumulative maximum demand
...	...
REG4 TRF8 CMD	Tariff #8 cumulative maximum demand
TOU MAX DMD REG5	Billing TOU Maximum Demand Register #5
REG5 TRF1 MD	Tariff #1 maximum demand
REG5 TRF2 MD	Tariff #2 maximum demand
...	...
REG5 TRF8 MD	Tariff #8 maximum demand
REG5 TRF1 CMD	Tariff #1 cumulative maximum demand
REG5 TRF2 CMD	Tariff #2 cumulative maximum demand
...	...
REG5 TRF8 CMD	Tariff #8 cumulative maximum demand
TOU MAX DMD REG6	Billing TOU Maximum Demand Register #6
REG6 TRF1 MD	Tariff #1 maximum demand
REG6 TRF2 MD	Tariff #2 maximum demand
...	...
REG6 TRF8 MD	Tariff #8 maximum demand
REG6 TRF1 CMD	Tariff #1 cumulative maximum demand
REG6 TRF2 CMD	Tariff #2 cumulative maximum demand
...	...
REG6 TRF8 CMD	Tariff #8 cumulative maximum demand
TOU MAX DMD REG7	Billing TOU Maximum Demand Register #7
REG7 TRF1 MD	Tariff #1 maximum demand
REG7 TRF2 MD	Tariff #2 maximum demand
...	...
REG7 TRF8 MD	Tariff #8 maximum demand
REG7 TRF1 CMD	Tariff #1 cumulative maximum demand
REG7 TRF2 CMD	Tariff #2 cumulative maximum demand
...	...
REG7 TRF8 CMD	Tariff #8 cumulative maximum demand
TOU MAX DMD REG8	Billing TOU Maximum Demand Register #8
REG8 TRF1 MD	Tariff #1 maximum demand
REG8 TRF2 MD	Tariff #2 maximum demand
...	...
REG8 TRF8 MD	Tariff #8 maximum demand
REG8 TRF1 CMD	Tariff #1 cumulative maximum demand
REG8 TRF2 CMD	Tariff #2 cumulative maximum demand
...	...
REG8 TRF8 CMD	Tariff #8 cumulative maximum demand

Appendix C PARAMETERS FOR DATA MONITORING AND LOGGING

Designation	Description
HARMONICS	1-second average ¹
V1 THD	V1 Voltage THD
V2 THD	V2 Voltage THD
V3 THD	V3 Voltage THD
PULSE COUNTERS	Gas/Water billing ¹
CNT1	Counter 1
.....	
CNT72	Counter 72
DI/DO STATUS	
DI1 - DI9	Digital Input 1 - Digital Input 9 Status
DI10 - DI18	Digital Input 10 - Digital Input 18 Status
DI19 - DI27	Digital Input 19 - Digital Input 27 Status
DI28 - DI36	Digital Input 28 - Digital Input 36 Status
DI37 - DI45	Digital Input 37 - Digital Input 45 Status
DI46 - DI54	Digital Input 46 - Digital Input 54 Status
DI55 - DI63	Digital Input 55 - Digital Input 63 Status
DI64 - DI72	Digital Input 64 - Digital Input 72 Status
DO1 - DO9	Relay output 1 - Relay output 9
DO10 - DO18	Relay output 10 - Relay output 18
ANALOG INPUTS	
A11 - A4	Analog Input 1 - Analog Input 4 value
A15 - A8	Analog Input 5 - Analog Input 8 value
A19 - A12	Analog Input 9 - Analog Input 12 value
A13 - A16	Analog Input 13 - Analog Input 16 value
PHASE ROTATON	
DAY AND TIME	

¹ Available for data logging. Harmonics will be implemented at Phase II design.

Appendix D Setpoints Triggers and Actions

Setpoint Triggers

Designation	Description
NONE	None (condition is not active)
MINUTE INTERVAL	Minute intervals (10, 15, 30, 60 min) synchronized with the clock
DAY OF WEEK	Day of week
YEAR	Year
MONTH	Month of the year
DAY OF MONTH	Day of month
HOURS	Hours
MINUTES	Minutes
HIGH V1	High V1 voltage
HIGH V2	High V2 voltage
HIGH V3	High V3 voltage
LOW V1	Low V1 voltage
LOW V2	Low V2 voltage
LOW V3	Low V3 voltage
HIGH V12	High V12 voltage
HIGH V23	High V23 voltage
HIGH V31	High V31 voltage
LOW V12	Low V12 voltage
LOW V23	Low V23 voltage
LOW V31	Low V31 voltage
HIGH I1	High I1 current
HIGH I2	High I2 current
HIGH I3	High I3 current
LOW I1	Low I1 current
LOW I2	Low I2 current
LOW I3	Low I3 current
HIGH FREQ	High frequency
LOW FREQ	Low frequency
HIGH kW IMP BD	High kW import
HIGH kW EXP BD	High kW export
HIGH kvar IMP BD	High kvar import
HIGH kvar EXP BD	High kvar export
HIGH kVA	High kVA
Stat Inp # 1 ON	Status Input # 1 ON
Stat Inp # 2 ON	Status Input # 2 ON
...	...
Stat Inp # 72 ON	Status Input # 72 ON
Stat Inp # 1 OFF	Status Input # 1 OFF
Stat Inp # 2 OFF	Status Input # 2 OFF
...	...
Stat Inp # 72 OFF	Status Input # 72 OFF
AI 1 cycle	Analog In 1 cycle average
AI 1 sec	Analog In 1 second average
AI raw	Analog In raw data

Setpoint Actions

Designation	Description
NONE	None (no action)
EVENT LOG	Log to Event Log
DATA LOG #1	Log to Data Log file #1
Clear VOLT/AMP DMD	Clear volt/ampere maximum demand
Clear PWR DMD	Clear maximum power demand
Clear ALL DMD	Clear all maximum demand
Clear TOU DMD	Clear TOU maximum demand
Clear Min/Max log	Clear minimum/maximum demand log
OPERATE REL #1 - # 18	Energize a specific Relay from 9RO module
RELEASE REL #1 - # 18	Dis-energize a specific Relay from 9RO module

Appendix E Data Scales

The maximum values for volts, amps and power in the BFM II setup and in communications are limited by the voltage and current scale settings. See [Basic Meter Setup](#) in Chapter 4 on how to change the voltage scale in your meter.

The following table defines the meter data scales.

Scale	Range	Notes
Maximum voltage (V max)	Voltage scale × PT Ratio, V	The default voltage scale is 600V
Maximum current (I max)	HACS Primary current × 2, A	The default HACS primary current is 50A
Maximum power ¹	V max × I max × 2, W	

¹ Maximum power is rounded to whole kilowatts. With PT=1.0, it is limited to 9,999,000 W.

Appendix F Device Diagnostic Codes

Diagnostic Code	Display Message	Description	Reason
2	RAM/Data fault	RAM/Data error	Hardware failure
3	Watchdog reset	Hardware watchdog reset	Hardware failure
4	Sampling fault	DSP/Sampling fault	Hardware failure
5	CPU exception	CPU exception	Hardware failure
6	Run-time error	Run-time error	Hardware failure
7	SW watchdog reset	Software watchdog timeout	Hardware failure
8	Power down	Power down	Loss of power
9	Device reset	Warm restart/Device reset	External restart via communications or by firmware upgrade.
10	Configuration reset	Configuration reset	Corrupted setup data has been replaced with the default configuration.
11	RTC fault	RTC fault	The clock time has been lost. With auto-reset: cleared automatically as the clock is updated.
12	Configuration fault	Configuration fault	Factory, calibration or basic device configuration data has been corrupted.
13	Low battery	Battery low	Low lithium battery. With auto-reset. Battery check or replacement is required.
14	Exp. memory fault	Expanded memory fault	Hardware failure
15	CPU EEPROM fault	CPU board EEPROM fault	Hardware failure
16	AC EEPROM fault	AC board EEPROM fault	Hardware failure
17	I/O EEPROM fault	I/O board EEPROM fault	Hardware failure
20	Library error	C Library error	Hardware failure
22	Task error	Task error	Hardware failure

See [Device Diagnostics](#) in Chapter 2 for more information on the BFM II built-in diagnostics.