



## Quick Start Guide

# EM132-133

expertmeter™



## Mechanical Installation

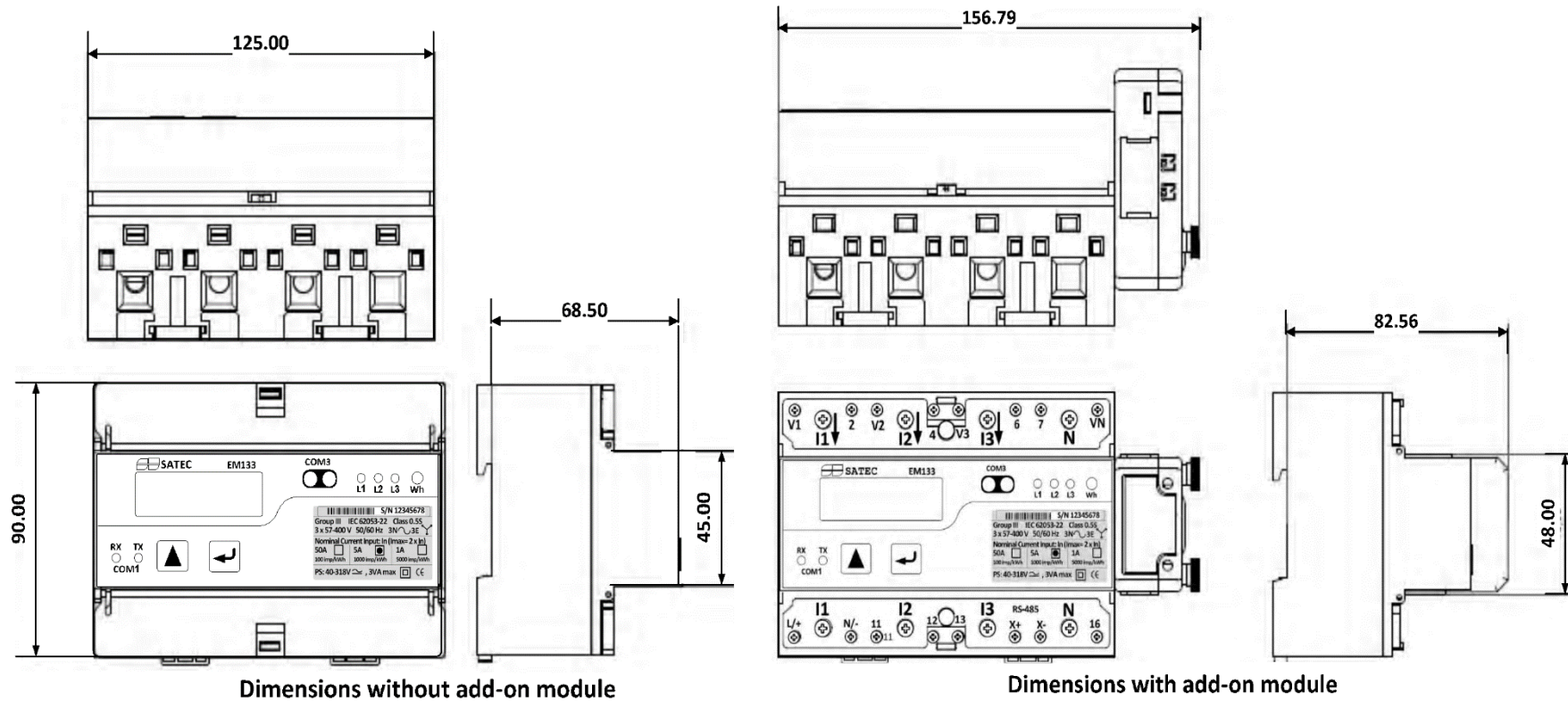

Figure 1: Instrument Dimensions

## Mechanical Installation

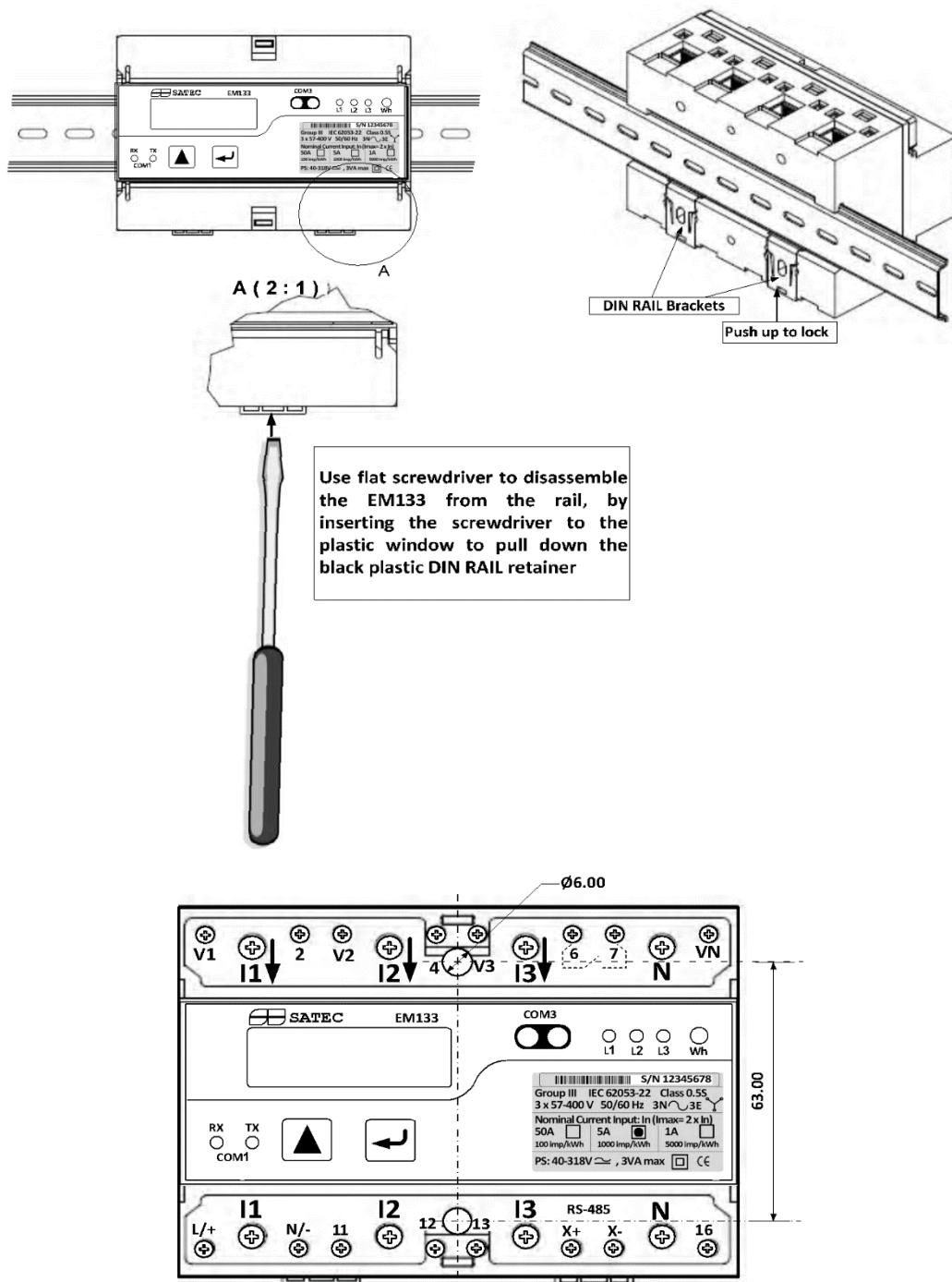

Figure 2: Mounting the EM13X on DIN Rail or on flat surface

### IMPORTANT!

#### Only qualified personnel can perform setup.

All incoming power sources must be turned off during installation. During operation of the Powermeter, hazardous voltages are present on the input terminals. Failure to observe precautions can result in serious or even fatal injury, or damage to equipment.

Please refer to the installation and operation manual for further information.

Typical Electrical Installation

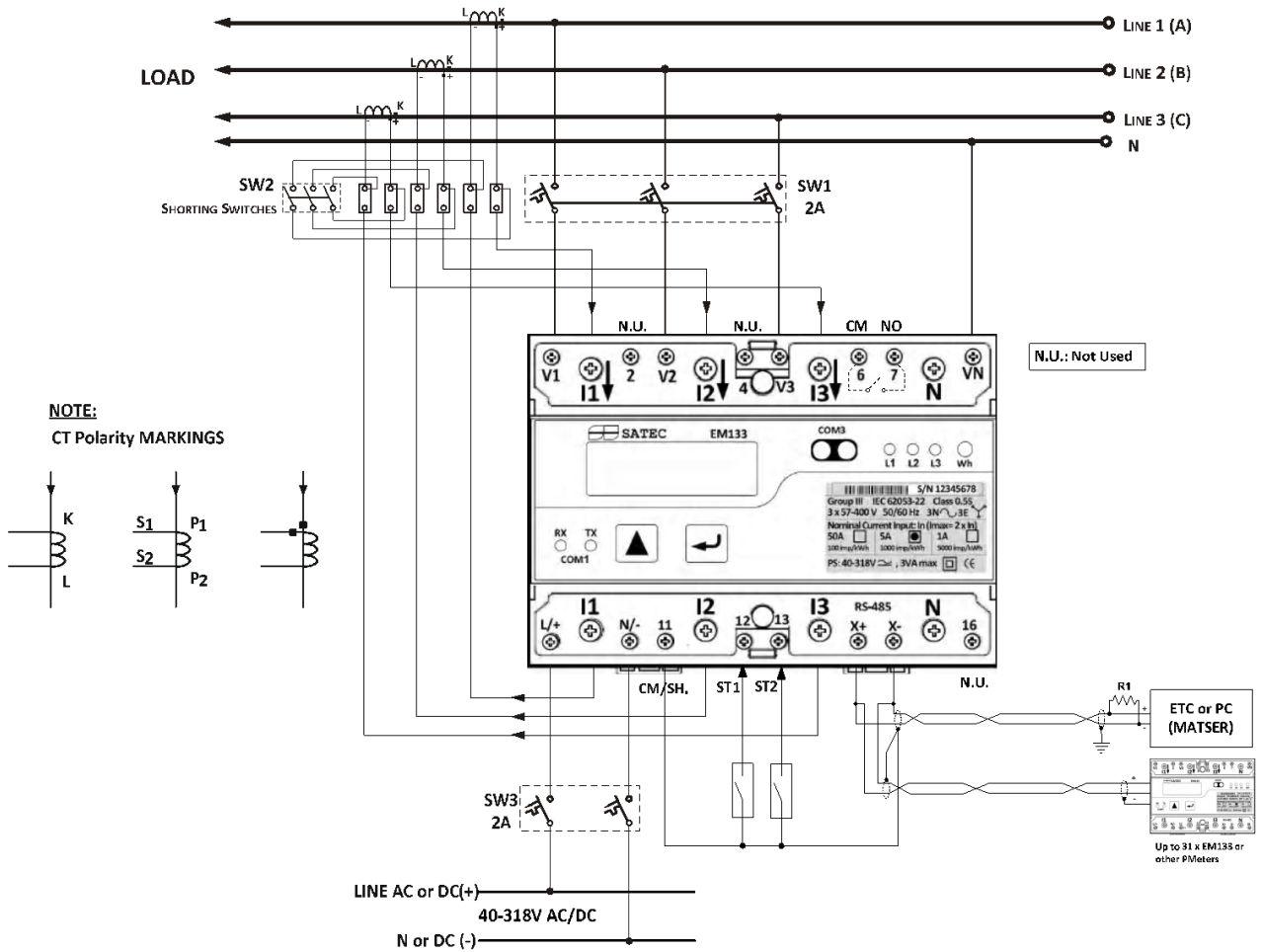

Figure 3: Common Wiring Mode: 4LL3 or 4Ln3

| Wiring Configuration  | Setup Code     |
|---|----------------|
| 3-wire 2-element Direct connection using 2 CTs                | 3dir2          |
| 4-wire Wye 3-element direct connection using 3 CTs            | 4Ln3 or 4LL3   |
| 4-wire Wye 3-element connection using 3 PTs, 3 CTs            | 4Ln3 or 4LL3   |
| 3-wire 2-element Open Delta connection using 2 PTs, 2 CTs     | 3OP2           |
| 4-wire Wye 2½ -element connection using 2 PTs, 3 CTs          | 3Ln3 or 3LL3   |
| 3-wire 2½ -element Open Delta connection using 2 PTs, 3 CTs   | 3OP3           |
| 4-wire 3-element Delta direct connection using 3 CTs          | 4Ln3 or 4LL3   |
| 3-wire 2½ -element Broken Delta connection using 2 PTs, 3 CTs | 3bLn3 or 3bLL3 |

**NOTE:**

Refer to the Installation and operation manual for the wiring schematics diagrams

**Electrical Installation**

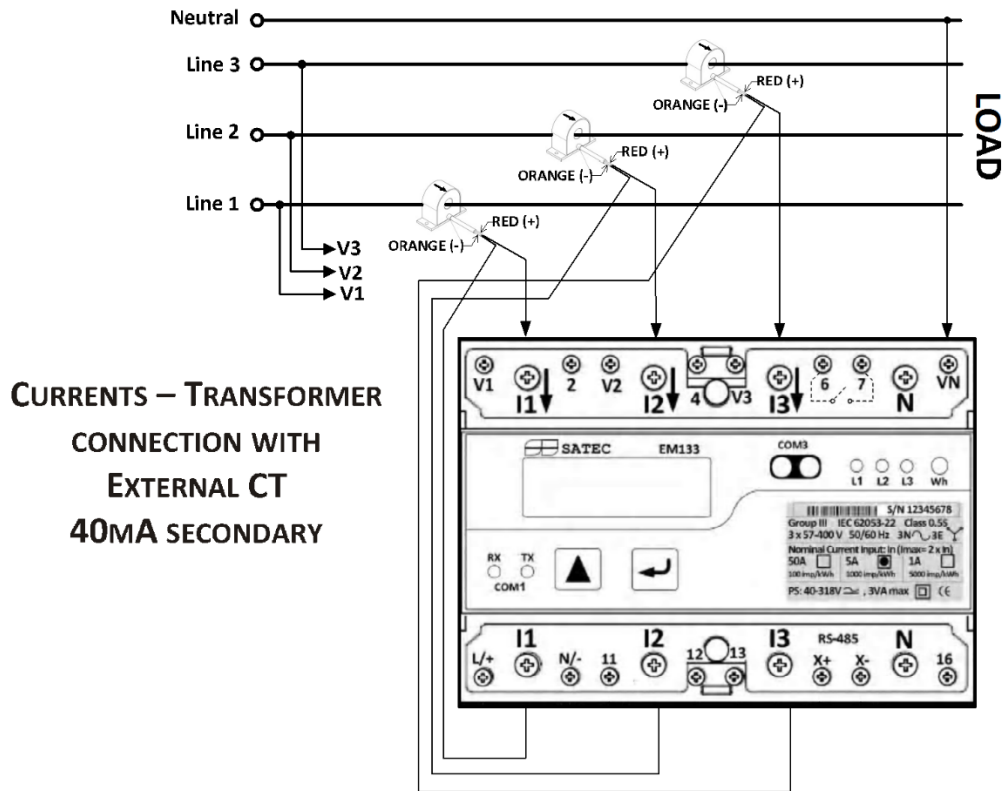
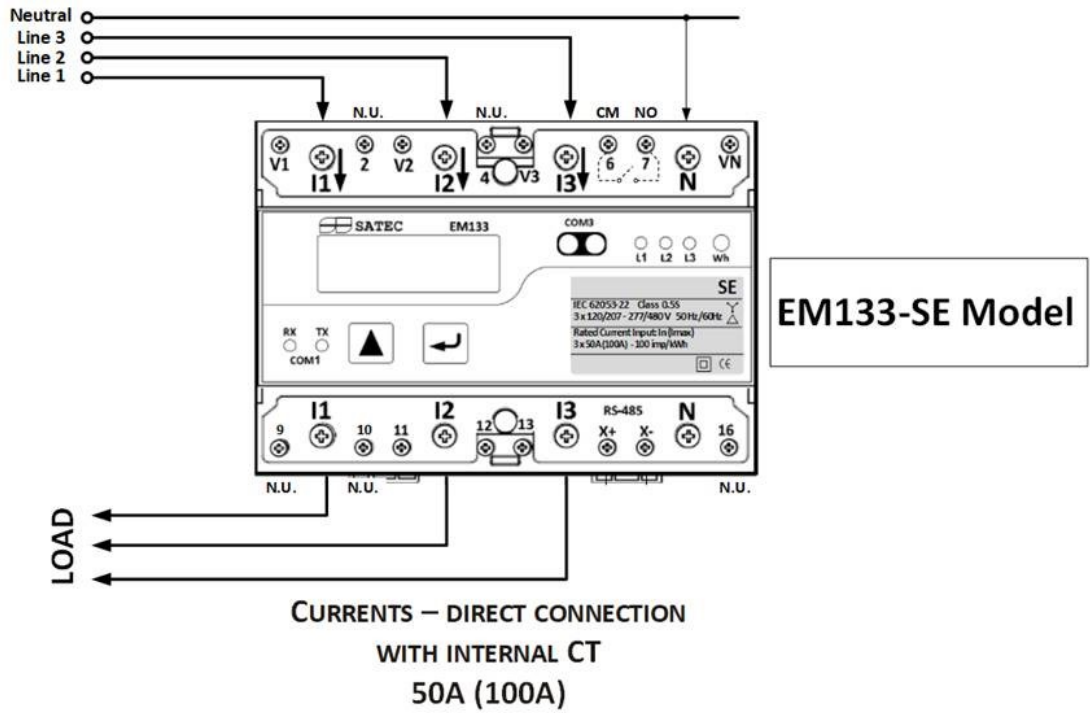

Figure 4: CT Wiring options

**MODULE Installation**

This section applies to the I/O and Communication modules.

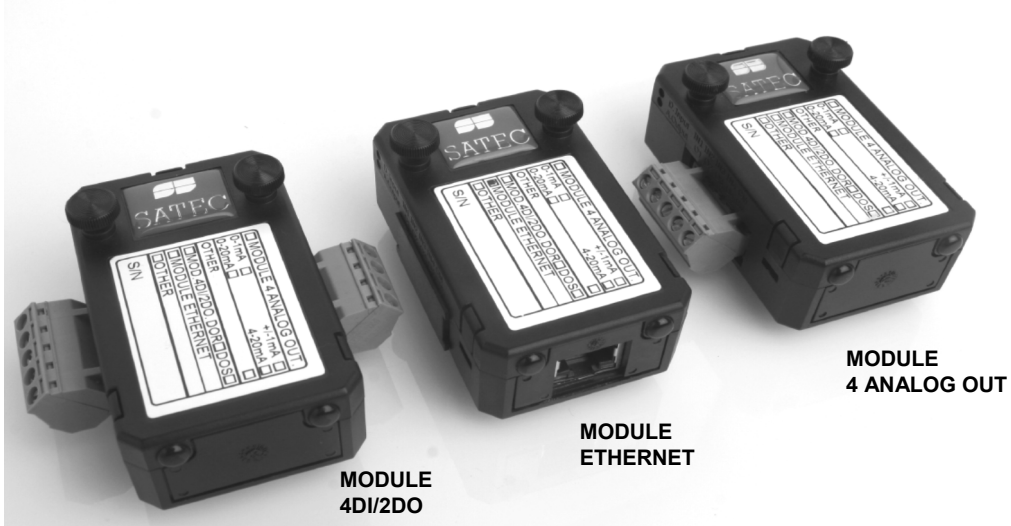

Figure 5: PM130 PLUS modules

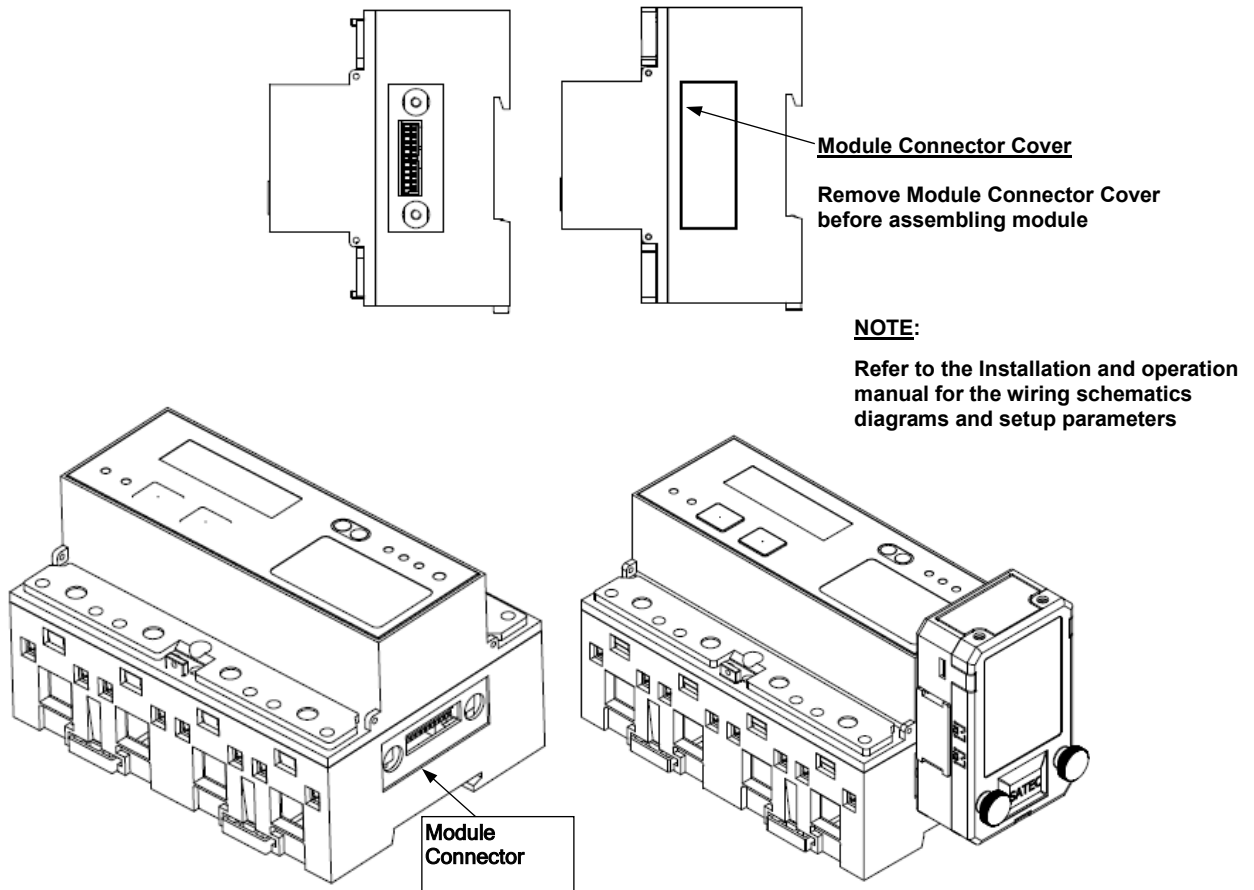

Figure 6: Mounting module

**CAUTION!**







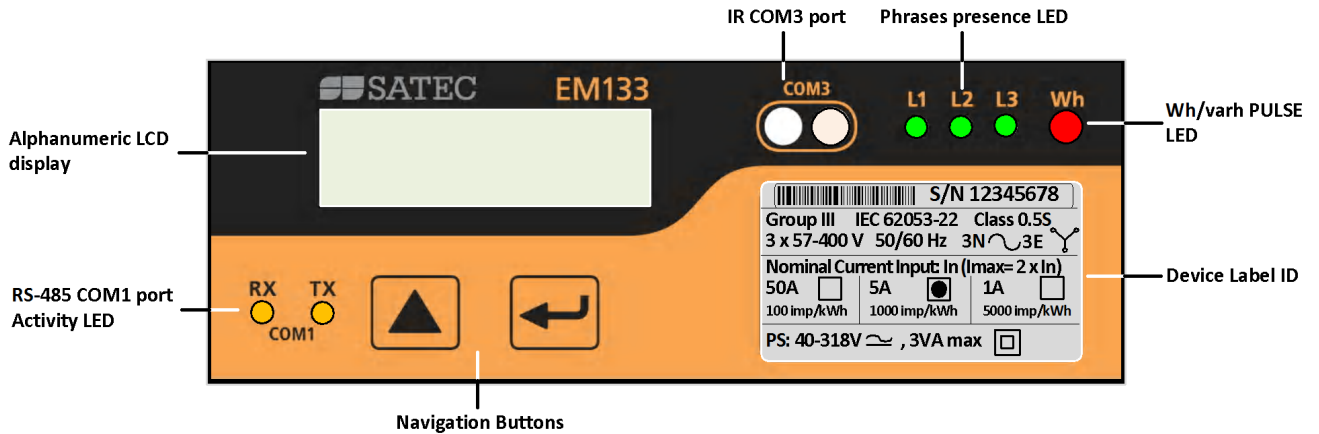







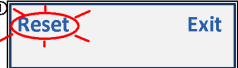
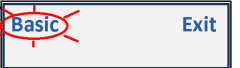

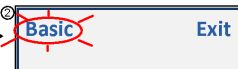
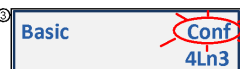

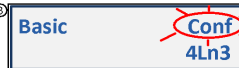
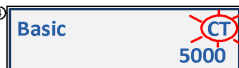
Before I/O Module installation ensure that all incoming power sources are shut OFF. Failure to observe this practice can result in serious or even fatal injury and damage to equipment.

## Basic Setup

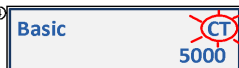
All setups can be performed directly from the display panel or via communication ports using PAS communication software, except for Communications and Display setups, which must be performed directly at the instrument panel.



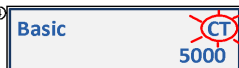

To set the CT Primary current, perform the following steps:

- Press  for 5sec, until password no. blinks:
  → 
- Enter Password number using , then press  for 2sec then new display with blinking "Reset"
  → 
- Navigate by pressing shortly (less than 1sec) 
 → 
- Press  for 2sec, until "Conf" blinks:
  → 
- Navigate by pressing shortly (less than 1sec) 
- Press  for 2sec, until "5000" blinks, then press shortly using  to the desired value
 
- Press  for 2sec, until "CT" blinks, then press  for 2sec, until "Basic" blinks, then press  for 2sec, until "Reset" blinks, press shortly using  to move to blinking "Exit" and press  for 2sec to return to initial screen
 



# DATA DISPLAY

## Navigating in Display Mode



The front panel has a simple interface that allows you to display numerous measurement parameters in up to 38 display pages. For easier reading, the parameters are divided into three groups; each group is accessible by pressing the  key and each group page is accessible by pressing the  key.



The initial display is as described below:









First push on  will display Energy measurement parameters, by pushing  will navigate to imp., exp. active/reactive, etc ...as described below:

|  |                      |                       |                       |
|--|----------------------|-----------------------|-----------------------|
| ①  Act. Imp<br>0 kWh    | ② Act. Exp<br>0 kWh  | ③ Rea. Imp<br>0 kvarh | ④ Rea. Exp<br>0 kvarh |
| ⑤  App.<br>0 kVAh       | ⑥ App. Imp<br>0 kVAh | ⑦ App. Exp<br>0 kVAh  |                       |
| ⑧  Rea. Q1<br>0 kvarh | ⑨ Rea. Q2<br>0 kvarh | ⑩ Rea. Q3<br>0 kvarh  | ⑪ Rea. Q4<br>0 kvarh  |

Second push on  will display MAX DMD parameters, by pushing  will navigate to MAX DMD P, Q, S, I, etc ...as described below:

|  |                          |                            |                            |
|--|--------------------------|----------------------------|----------------------------|
| ①  MAX. DMD<br>P Imp 0 MW | ② MAX. DMD<br>P Exp 0 MW | ③ MAX. DMD<br>Q Imp 0 Mvar | ④ MAX. DMD<br>Q Exp 0 Mvar |
| ⑤  MAX. DMD<br>S 0 MVA    | ⑥ MAX. DMD<br>I1 0 A     | ⑦ MAX. DMD<br>I2 0 A       | ⑧ MAX. DMD<br>I3 0 A       |
| ⑨  MAX. DMD<br>In 0 A     | ⑩ MAX. DMD<br>V1 0 kV    | ⑪ MAX. DMD<br>V2 0 kV      | ⑫ MAX. DMD<br>V3 0 kV      |

Third push on  will display Voltage/Current measurements, by pushing  will navigate to V (L-N), V (L-L), I, Power, PF, THD, TDD, F, etc ...as described below:

|  |                            |                            |                            |
|--|----------------------------|----------------------------|----------------------------|
| ①  V1 0 kV<br>V2 0 kV       | ② V3 0 kV                  | ③ V12 0 kV<br>V23 0 kV     | ④ V31 0 kV                 |
| ⑤  I1 0 A<br>I2 0 A         | ⑥ I3 0 A<br>In 0 A         | ⑦ P 0 MW<br>Q 0 Mvar       | ⑧ S 0 MVA<br>PF 0          |
| ⑨  V1 THD 0 %<br>I1 THD 0 % | ⑩ V2 THD 0 %<br>I2 THD 0 % | ⑪ V3 THD 0 %<br>I3 THD 0 % | ⑫ I1 TDD 0 %<br>I2 TDD 0 % |
| ⑬  I3 TDD 0 %               | ⑭ V Unb 0 %<br>I Unb 0 %   | ⑮ Freq 0 Hz                |                            |
| ⑯  V1 Ang 0°<br>I1 Ang 0°   | ⑰ V2 Ang 0°<br>I2 Ang 0°   | ⑱ V3 Ang 0°<br>I3 Ang 0°   |                            |



## Basic Menu

| Code             | Parameter                      | Options                         | Description   |
|------------------|--------------------------------|---------------------------------|---|
| <b>Conf</b>      | Wiring mode                    | 3OP2                            | 3-wire open delta using 2 CTs   |
|                  |                                | 4Ln3                            | 4-wire Wye using 3 PTs (default)  |
|                  |                                | 3dir2                           | 3-wire direct connection using 2 CTs  |
|                  |                                | 4LL3                            | 4-wire Wye using 3 PTs  |
|                  |                                | 3OP3                            | 3-wire open delta using 3 CTs   |
|                  |                                | 3Ln3                            | 4-wire Wye using 2 PTs  |
|                  |                                | 3LL3                            | 4-wire Wye using 2 PTs  |
|                  |                                | 3bLn3                           | 3-wire Broken delta using 2 PTs, 3 CTs  |
|                  |                                | 3bLL3                           | 3-wire Broken delta using 2 PTs, 3 CTs  |
| <b>Pt Ratio</b>  | PT ratio                       | 1.0* - 6,500.0                  | The potential transformer ratio   |
| <b>Pt Factor</b> |                                |                                 |   |
| <b>Ct</b>        | CT primary current             | 1-50,000A (5*)                  | The primary rating of the current transformer   |
| <b>PowDmdPer</b> | Power demand period            | 1, 2, 5, 10, 15*, 20, 30, 60, E | The length of the period for power demand calculations, in <b>minutes</b> . E = external synchronization        |
| <b>Num.Per.</b>  | Number of power demand periods | 1-15 (1*)                       | The number of demand periods to be averaged for sliding window demands<br>1 = block interval demand calculation |
| <b>ADmdPer.</b>  | Ampere/Volt demand period      | 0-1800 (900*)                   | The length of the period for volt/ampere demand calculations, in <b>seconds</b> . 0 = measuring peak current    |
| <b>Frequency</b> | Nominal frequency              | 25, 50, 60, 400 (Hz)            | The nominal power utility frequency   |
| <b>MaxDmdLd</b>  |                                |                                 |   |

- Default setup

## Communication Port Menu

### COM1 setting

| Code              | Parameter               | Options   | Description                                    |
|-------------------|-------------------------|---|--|
| <b>Protocol</b>   | Communications protocol | ASCII*, rtu, dnP3   | ASCII, Modbus RTU (default) or DNP3.0 protocol |
| <b>Interface</b>  | Interface standard      | 485   | RS-485 interface (default)                     |
| <b>Address</b>    | Address                 | ASCII: 0 (default) - 99, Modbus: 1 (default) -247, DNP3.0: 0 (default) -255 |  |
| <b>Baud Rate</b>  | Baud rate               | 110, 300, 600, 1200, 2400, 4800, 9600 (default), up to 115,200 bps          |  |
| <b>Data/Party</b> | Data format             | 7E, 8E (7/8 bits, even parity), 8n (default) (8 bits, no parity)            |  |
| <b>Snd.Delay</b>  |                         |   |  |

## Input and Output Ratings

|  |  |  |
|--|--|--|
| <b>3 voltage inputs</b>                          | <b>57/98-400/690 VAC</b>   | DIRECT INPUT - Nominal: 690V line-to-line voltage, 828V maximum; 400V line-to-neutral, 480V maximum - Burden: <0.5 VA. INPUT USING PT - Burden: <0.15 VA |
|  | <i>Voltage input terminals</i>   | 4 x Maximum wire section: 2.5 mm <sup>2</sup> (12 AWG)   |
| <b>3 current inputs<br/>(Galvanic isolation)</b> | <i>/5A(10A)</i>  | INPUT VIA CT with 5A secondary output - Burden: <0.2VA, Overload withstands: 20A RMS continuous, 300A RMS for 0.5 second.                                |
|  | <i>/1A(2A)</i>   | INPUT VIA CT with 1A secondary output - Burden: <0.05VA, Overload withstands: 3A RMS continuous, 80A RMS for 0.5 second.                                 |
|  | <i>50A(100A)</i>   | INPUT VIA CT with 50A direct connection - Burden: < 0.05VA, Overload withstands: 120A RMS continuous, 2000A RMS for 0.5 second.                          |
|  | <i>40mA:(optional)</i>   | INPUT VIA CT with 40mA secondary output, using external CT – Split Core CT or Solid Core CT – primary 100-1200A maximum rating                           |
|  | <i>Current input terminals</i>   | 3 x Maximum wire section: 16 mm <sup>2</sup>   |
| <b>Communication port<br/>COM1</b>               | <i>EIA RS-485 standard</i>   | Optically isolated, max. speed 115.2Kb/s   |
|  | <i>COM1 terminals</i>  | 3 x Maximum wire section: 2.5 mm <sup>2</sup>  |
| <b>Communication port<br/>COM3</b>               | <i>IR COM port</i>   | Infra Red, max. speed 38.4Kb/s   |
| <b>Power Supply<br/>(Galvanically isolated)</b>  | <i>40-300V AC/DC<br/>(standard)</i>  | 50/60 Hz - 9VA   |
|  | <i>Power Supply input terminals</i>  | 3 x Maximum wire section: 2.5 mm <sup>2</sup>  |
| <b>MODULE 2DI/DO</b>                             | <i>DIGITAL INPUT x 2<br/>optically isolated inputs</i>                             | Dry contact, internally wetted @ 5VDC  |
|  | <i>DIGITAL OUTPUT x 1</i>  | 0.15A/250 VAC - 400 VDC, 1 contact (SPST Form A)   |
|  | <i>2DI/DO terminals</i>  | 5 x Maximum wire section: 2.5 mm <sup>2</sup>  |
| <b>MODULE 4DI/2DO<br/>(Optional)</b>             | <i>DIGITAL INPUT x 2<br/>optically isolated inputs</i>                             | Dry contact, internally wetted @ 24VDC   |
|  | <i>DIGITAL OUTPUT x 2</i>  | <i>EMR</i> 5A/250 VAC; 5A/30 VDC, 1 contact (SPST Form A)  |
|  |  | <i>SSR</i> 0.15A/250 VAC - 400 VDC, 1 contact (SPST Form A)  |
|  | <i>4DI/2DO terminals</i>   | 9 x Maximum wire section: 2.5 mm <sup>2</sup>  |
| <b>MODULE 4 AO<br/>(Optional)</b>                | <i>ANALOG OUT x 4<br/>optically isolated<br/>outputs<br/>(4 different options)</i> | $\pm 1$ mA, maximum load 5 k $\Omega$ (100% overload)  |
|  |  | 0-20 mA, maximum load 510 $\Omega$   |
|  |  | 4-20 mA, maximum load 510 $\Omega$   |
|  |  | 0-1 mA, maximum load 5 k $\Omega$ (100% overload)  |
|  | <i>4 AO terminals</i>  | 5 x Maximum wire section: 2.5 mm <sup>2</sup>  |
| <b>Communication port<br/>COM2 (Optional)</b>    | <i>Ethernet</i>  | 10/100 Base T, auto adaptation speed, Max. speed 100Mb/s   |
|  | <i>ETH connector</i>   | Shielded RJ45 cable  |
| <b>Communication port<br/>COM2 (Optional)</b>    | <i>Profibus</i>  | Max. speed 12 Mb/s   |
|  | <i>Profibus terminals</i>  | 5 x Maximum wire section: 2.5 mm <sup>2</sup> (12 AWG) or using terminal to DB9 converter: P/N AC0153 REV.A2   |
| <b>Communication port<br/>COM2 (Optional)</b>    | <i>EIA RS-232-422/485<br/>standard</i>   | Optically isolated, max. speed 115.2Kb/s – <i>to be connected to GPRS modem if ordered</i>   |
|  | <i>COM2 terminals</i>  | 5 x Maximum wire section: 2.5 mm <sup>2</sup><br>And DB9 connector   |